

ROMBULL®

Avanzamos contigo / Moving forward with you

REDES DE SEGURIDAD

Safety nets



REDES DE DEPORTE

Sport nets



CORDELERÍA NATURAL

Natural ropes



REDES DE INDUSTRIA

Industrial netting



PARQUES DE AVENTURA

Adventure parks

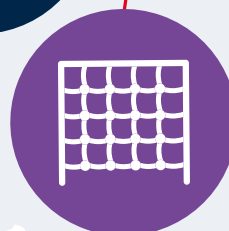

Solución
360°



CORDELERÍA

Ropes



CABLES, CADENAS Y ACCESORIOS

Wire ropes, chains and accessories

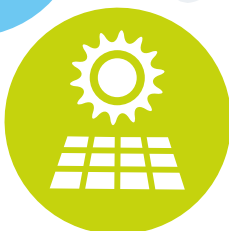

MALLAS DE SOMBREO Y OCULTACIÓN

Shade nets



PULPOS, REDES ELÁSTICAS Y TRINCAJES

Stretch cords, tie-down, straps & elastic nets

CABUYERÍA NÁUTICA

Nautical ropes

• Introducción empresa - Firm's introduction	6-7
• Valores Rombull - Rombull core values	8
• Usted pone el espacio, Rombull el proyecto - You provide the space, Rombull the project	9, 10, 11
• Respeto medioambiental y calidad certificada - Environmental care and certified quality	12-13
• Máximo control de calidad - Maximum quality control	14



REDES DE SEGURIDAD - SAFETY NETS

• Normativa - Regulation	16
• Términos y condiciones - Terms and conditions	16
• Clasificación redes - Net classification	16
• Sistemas de redes - Nets systems	17
• Tipos de cuerdas - Types of rope	18
• Tipos de cuerdas y mallas - Rope and mesh types	18
• Formación - Training	19
• SAT Servicio atención al cliente - SAT Customer service	19
• La gama más completa de redes de seguridad - The most complete range of safety nets	20-21
• Sistema V - V System	22-25
• Redes horizontales y de protección de borde - Horizontal nets and edge protection	26
• Sistema S - S System	27-29
• Sistema U - U System	30-32
• Sistema T - T System	32
• Sistemas U / cerramiento fachadas - U System / of front closure	33-34
• Red antidesprendimientos de fachadas - Nets to prevent debris falling from crumbling fronts-closure	34
• Sistema de protección de fachada - Security system of fronts	35
• Posicionamiento en el trabajo - Work positioning	36-37
• Bajo forjado - Forged under	38
• Ganchos - Hooks	38
• Redes de seguridad bajo forjado recuperables - Safety low underwork reusable nets	39
• Cordelería EN 1263-1 - Standard EN 1263-1	40
• Cuerda de unión - Coupling rope	41
• Cuerda atado sistema V uso doble - Tie rope V system dual use	41
• Cuerda atado sistema S uso doble - Tie rope S system dual use	42
• Cuerda atado sistema V - Tie rope V system	43
• Cuerda atado sistema S - Tie rope S system	44
• Static 10,5 - Static 10,5	45
• Conservación / Mantenimiento - Conservation / Maintenance	46-47
• Etiqueta - Label	48
• Acabados y accesorios - Finishing and accessories	49-50



REDES DE DEPORTE - SPORT NETS

• Normativa - Normative	52
• Nomenclatura - Nomenclature	53
• Fútbol 11 - Football 11	54-58
• Fútbol 7 - Football 7	59-63
• Fútbol 5 - Football 5	64-68
• Fútbol playa - Beach soccer	69
• Mini porterías - Mini goals	70
• Balonmano / Fútbol sala - Handball / Football indoor	71-73
• Tenis - Tennis	74-76
• Bádminton - Badminton	77
• Pádel federación - Padel federation	78-79
• Pádel - Padel	80
• Redes de protección superior pádel - Padel superior protection nets	81
• Voleibol - Volleyball	82-83
• Voley playa - Beach volley	84
• Baloncesto - Basketball	85
• Jaulas de lanzamiento - Cages	85
• Críquet - Cricket	86
• Béisbol - Baseball	86
• Esquí - Skiing	87
• Redes de cortina - Curtain nets	88
• Redes de techo - Nets for ceiling	88
• Redes de protección - Protection nets	89-90
• Accesorios instalación red protección - Accessories for net installation	91
• Golf - Golf	92
• Hockey hielo y patines - Ice & roller hockey	93
• Hockey hierba y sala - Grass & indoor hockey	93
• Accesorios - Accessories	94



PARQUES DE AVENTURA - ADVENTURE PARKS

• Introducción - Introduction	96
• Adventure Knot	98
• Adventure Ring	98
• Adventure Stirrup	98
• Adventure Up	99
• Adventure Zip Line	99
• Adventure fastening	99
• Adventure Climbing net	100
• Adventure Flying net	100
• Adventure Walk net	100
• Adventure Monkey Bridges	101
• Adventure Climb Rings	101
• Adventure without harness	101
• Parques infantiles e hinchables - Playgrounds and inflatables	102
• Paintball	103



REDES DE INDUSTRIA - INDUSTRIAL NETS

• Introducción - Introduction	106
• Redes industriales polipropileno - Polypropylene industrial nets	106
• Redes para cubrir cargas - Networks to cover charges	107
• Red para repisas y estanterías - Nets for shelves	108
• Red de protección de vías de fabricación y conveyor - Protection nets for manufacturing chains and conveyors	109
• Redes para carros de transporte, división de secciones y cierres de altillos - Nets for industrial trolleys, divide sections & closing upper areas	110
• Red camión, separa carga, cargas suspendidas y palets cargo - Nets for trucks, separating loads, for helicopters & pallets	111
• Red huecos, tendido eléctrico y cerramiento vertederos - Nets for workshop ditches to cover gaps, power line & closing landfills	112
• Red industria colores naturales - Natural colors red industry	113
• Redes flame retardant - Flame retardant nets	114



CORDELERÍA - ROPES

• Comparativa de características de las fibras - Comparative characteristics of the fibers	116
• Tipos de cuerda según su construcción - Types of rope by construction	116
• Descripción de la etiqueta - Label description	116
• Terminología y pictogramas - Terminology and pictograms	118
• Nudos - Knots	118-119
• Indicaciones - Indications	120-121
• Hilo replanteo polipropileno trenzado 1,5 a 2,3 mm - Polypropylene braided thread 1,5 to 2,3 mm	122
• Hilo replanteo poliamida trenzado 1,3 a 2,3 mm - Polyamide braided thread 1,3 to 2,3 mm	123
• Hilo redondo poliamida 1,5 mm - Polyamide thread 1,5 mm	123
• Hilo replanteo poliéster trenzado colores 1,8 mm - Braided polyester color thread 1,8 mm	124
• Hilo polipropileno cableado 1,1 a 1,4 mm - Polypropylene twisted thread 1,1 to 1,4 mm	125
• Hilo algodón 1 a 1,8 mm - Cotton thread 1 to 1,8 mm	125
• Hilos de rafia de polipropileno 1,3 a 3,4 mm - Polypropylene raffia thread 1,3 to 3,4 mm	126
• Hilos rafia especial balas empacadora y rotoempacador - Special raffia thread ideal for packaging	127
• Rafia 1200 polietileno butano - Raffia 1200 polyethylene	127
• Cordón riel polipropileno 2,5 mm - Polypropylene rail cord 2,5 mm	128
• Cordón riel poliamida 2,5 mm - Polyamide rail cord 2,5 mm	128
• Cordón polietileno 3 mm - Polyethylene cord 3 mm	129
• Cordón fantasía poliéster 1,5 a 4 mm - Polyester fantasy cord 1,5 to 4 mm	130-131
• Cuerda cableada polietileno 4 cabos plastificada - Coated polyethylene twisted cord 4 strands	132
• Cordón fantasía poliéster plastificada - Plastified polyester cord fantasy	133
• Cable de acero plastificado 3,5 mm - PVC coated steel wire 3,5 mm	134
• Cordón polipropileno alma texturada 4 a 6 mm - Polypropylene cord / textured core 4 to 6 mm	135
• Cordón poliéster con alma 4 mm - Polyester cord textile core 4 mm	136
• Cuerda arranque de motores - Starter cord	138
• Cuerda especial teléfonos 3 a 5 mm - Polyethylene twisted cord 3 to 5 mm	139
• Cuerda cableada de polietileno 3 a 6 mm - Polyethylene twisted cord 3 to 6 mm	140-141
• Cuerda algodón trenzada con alma 4 a 5 mm - Braided cotton rope 4 to 5 mm	142
• Cuerda trenzada polipropileno 3 a 6 mm - Polypropylene braided cord 3 to 6 mm	143
• Cuerda trenzada poliéster 3 a 6 mm - Polyester braided cord 3 to 6 mm	144
• Cuerda trenzada poliamida 3 a 6 mm - Polyamide braided cord 3 to 6 mm	145
• Cuerda cableada de polipropileno 5 a 20 mm - Polypropylene twisted rope 5 to 20 mm	146
• Cuerda de fibra ISO 1140 A poliamida - Polyamide fiber rope ISO 1140	147

• Cuerda cableada polysteel - Polysteel twisted rope	148
• Hilo de pesca - Fishing line	148
• Cuerda cableada polietileno 8 a 20 mm - Polyethylene twisted rope 8 to 20 mm	149
• Cuerda cableada nylon mate - Nylon mate twisted rope	150
• Cuerda mate trenzada con alma - Nylon mate braided rope	150
• Cuerda polipropileno 100% trenzada con alma - 100% polypropylene double braided rope	151
• Cuerda poliéster 100% trenzada con alma - 100% polyester double braided rope	152
• Cuerda poliéster flúor 100% trenzada con alma - 100% polyester fluor double braided rope	153
• Cuerda poliéster 100% trenzada con alma - 100% Polyester color rope double braided	154-155
• Cuerda poliamida 100 % trenzada con alma - 100% polyamide double braided rope	156
• Cuerda polipropileno trenzada alma mt - Polypropylene double braided rope mt-core	157
• Cuerda polipropileno trenz. alma mt amarillo/rojo - Polypropylene double braided rope-mt core yellow/red	158
• Cuerda poliéster trenzada alma mt - Polyester braided rope - mt core	159
• Cuerda poliamida trenzada alma mt - Polyamide braided rope - mt core	160
• Cuerda algodón trenzada con alma - Cotton braided rope	161
• Cuerda elástica - Elastic rope	162-163
• Cuerda polipropileno 100% trenzada con alma - 100% polypropylene double braided rope	164-165
• Cuerdas flame retardant - Flame retardant rope	166
• Cuerda espiroide - Spiroide rope	167



CORDELERÍA NATURAL - NATURAL ROPES

• Cordelería natural - Natural ropes	170
• Lino - Linen	171
• Sisal - Sisal	171
• Algodón - Cotton	172
• Yute - Jute	172
• Coco - Coconout	173
• Cáñamo - Hemp	173
• Hilo lino - Linen thread	174
• Hilo pulido - Polished thread	175
• Hilo sisal - Sisal thread	176
• Cuerda cableada sisal - Twisted sisal rope	177
• Hilo algodón - Cotton thread	178
• Cuerda algodón - Cotton rope	179
• Cuerda yute - Jute rope	180
• Cuerda cableada cáñamo - Twisted hemp rope	182



MALLAS SOMBREO Y OCULTACIÓN - SHADE NETS

• Malla sombreo 40%, 50% y 60% - Shade nets 40%, 50% & 60%	184
• Malla sombreo 70% - Shade nets 70%	185
• Malla ocultación 80% - Shade nets 80%	186
• Malla ocultación 90% - Shade nets 90%	187
• Pieza plástica - Plastic piece	187
• Malla garden plus - Garden nets plus	188
• Malla flame retardant - Flame retardant nets	189
• Malla sombreo bicolor 70% y 80% - Bicolor shade nets 70% and 80%	190
• Malla ocultación bicolor 90% - Bicolor shade nets 90%	190
• Malla sombreo 70%, construcción 90% y señalización - Shade nets 70%, construction nets 90% & signaling	191
• Antigranizo - Anti hail	192
• Mosquiteras - Mosquito net	193
• Antihierba - Ground cover	193
• Red garden - Garden net	194
• Expositores mallas - Shade net exhibitors	195



CABUYERÍA NAUTICA - NAUTICAL ROPES

• Comparativa de características de las fibras - Comparative characteristics of the fibers	198
• Novoleen	199
• Cabo Rombull Minkar - Rombull Minkar strand	200
• Cabo Rombull Adhara (cuerda amarre) - Rombull Adhara strand (moorage rope)	201
• Accesorios de amarre - Moorage accessories	202-203
• Cabo Rombull Serpens - Rombull Serpens strand	204
• Cabo Rombull Antares - Rombull Antares strand	205
• Cabo Rombull Altair - Rombull Altair strand	206
• Cabo Rombull Spica - Rombull Spica strand	207
• Cabo Rombull Sirio - Rombull Sirio strand	208
• Cabo Rombull Nashira - Rombull Nashira strand	209
• Cabo Rombull Tureis Novoleen - Rombull Tureis Novoleen strand	210
• Cabo Rombull Vega Novoleen - Rombull Vega Novoleen strand	211

• Cabo Rombull Situla Novoleen - Rombull Situla Novoleen strand	212
• Cabo Rombull Deneb - Rombull Deneb strand	213
• Cabo Rombull Cursa - Rombull Cursa strand	214
• Cabo Rombull Gatria - Rombull Gatria strand	215
• Línea Clásica - Classic line:	
- Cabo Rombull Natura-C - Rombull Natura-C strand	216
- Cabo Rombull Natura-T - Rombull Natura-T strand	217
• Grillete textil Rombull Novoleen - Novoleen shackle	218
• Cabo Rombull Cordino - Rombull Cordino strand	219
• Cordón Rombull Rainbow - Rainbow cord Rombull	220-221
• Accesorios elásticos - Elastic accessories	222



PULPOS, REDES ELÁSTICAS Y CORREAS DE AMARRE STRECH CORDS, TIE-DOWN STRAPS & ELASTIC NETS

• Trincajes, información y acabados - Tie-down straps, information and finishes	224
• Pulpo strong - Strong bungee	225
• Pulpo medium - Medium bungee	226
• Pulpo ajustable - Adjustable canopy ties	227
• Pulpo plano - Bungee with adjustable hook	227
• Redes elásticas - Elastics nets	228
• Trincaje - Tie-down straps	229, 231, 233
• Pulpos goma elástica - Elastic bungee cord	232
• Trincaje profesional - Profesional tie-down straps	234-235
• Cajas dispensadoras - Dispensing boxes	236



CABLES, CADENAS Y ACCESORIOS - WIRE ROPES, CHAINS AND ACCESSORIES

• Cables - Wire ropes:	238-239
- Cable de acero - Steel wire ropes	240
- Cable de acero inoxidable - Stainless steel wire ropes	240
- Cable de acero plastificado - PVC coated steel wire ropes	241
- Alambre galvanizado - PVC coated steel wire ropes	241
- Alambre plastificado - PVC coated steel wire ropes	241
• Cadenas - Chains:	242-243
- Cadena de acero DIN 5685-1 - Round-steel chains DIN 5685-1	244
- Cadena de acero inoxidable - Stainless steel chains	245
- Cadena de acero DIN 5685-2 - Round-steel chains DIN 5685-2	246
- Cadena de polietileno - PE-Plastic chains	247
- Cadena redondeada - Small twisted chains	248
- Cadena de nudos DIN 5686 - Knotted chains DIN 5686	248
- Cadena barbada - Curb chains	249
- Cadena malla - Chandelier chains	249
- Cadena decoración - Decorative chains	250
- Cadena de reloj - Clock chains	251
• Accesorios - Accessories:	252
- Mosquetón bombero con seguro - Carabiner snap hook with screw	253
- Mosquetón Bombero inoxidable - Stainless steel carabiner snap hook	254
- Mosquetón Bombero cincado - Zinc-plated carabiner snap hook	255
- Mosquetón con seguro inoxidable - Stainless steel quick link with screw	256
- Mosquetón con seguro cincado - Zinc-plated quick link with screw	257
- Grillete con perno inoxidable - Stainless steel schackle	258
- Grillete con perno cincado - Zinc-plated schackle	259
- Guardacabo - Thimble	260
- Tensor gancho con argolla - Turnbuckle with hook and eye	261
- Sujetacable inoxidable - Stainless steel wire rope clip	262
- Sujetacable cincado - Zinc-plated wire rope clip	263
- Sujetacable plano simple inoxidable - Stainless steel wire rope clip simplex	264
- Sujetacable plano simple cincado - Zinc-plated wire rope clip simplex	265
- Sujetacable plano doble inoxidable - Stainless steel wire rope clip duplex	266
- Sujetacable plano doble cincado - Zinc-plated wire rope clip duplex	267
- Eslabón roto acero cincado - Repair links	268
- Eslabón roto polietileno - PE-Plastic quick link	269
- Eslabón roto polietileno con gancho - PE-Plastic hooks / connector	269
- Grillete giratorio - Swivels	270
- Mosquetón aluminio - Snap hook aluminium anodized	271
- Anilla elevación cincada macho - Ring screws	272
- Anilla elevación cincada hembra - Ring nuts	273
- Gancho con rosca - Screw hook	274
- Gancho columpio - Swing hook	275
- Gancho de amarre - Snap hook forged with spring catch	276

- Gancho tipo S - S-Hook	277
- Anillo - Rings	278
- Gancho de mosquetón - Snap hook	279
- Llavero con cadena - Curb chain sets	279
- Polea de desviación - Pulley made of polyamide	280
- Polea de elevación - Hoist pulleys standard duty	280
- Roldana simple - Rope pulley single wheel	281
- Roldana doble - Rope pulley twin wheel	281
- Tornillo de ojo - Eyelet bolts	282
- Tornillo de ojo con argolla - Eye bolts	282
- Gancho hamaca - Hammock hook	283
- Placa con semianillo - Eye plate	283
- Gancho simple - Simplex hook	284
- Ajustador de cuerda - Rope extender	284
- Gancho carnicero - Meat hooks	285
- Gancho tornillo - Screw hook for clothes lines	285
- Mosquetón nylon - Nylon snap hook	286
- Gancho negro power grip - Power grip black hook	286
- Gancho metálico plastificado - Plastic coated metallic hook	286
- Gancho plástico blanco - White plastic hook	287
- Gancho plástico negro - Black plastic hook	287
- Mosquetón Rombull - Rombull snap hook	288
- Mosquetón clip - Clip snap hook	289

Polígono propio de 50.000 m² Un grupo industrial a su servicio

Own industrial estate of 50.000 m². An industrial group at your service.



Coordenadas GPS
GPS Coordinates
Latitud **38° 07' 39.9" N**
Longitud **0° 50' 49.5" W**

Camino Los Clérigos • Apdo. 9
03360 CALLOSA DE SEGURA
(Alicante)





- 1. Redes de seguridad - Safety nets
- 2. Redes de deporte - Sport nets
- 3. Redes de industria - Industrial netting
- 4. Cordelería - Ropes
- 5. Mallas de sombreado y ocultación - Shade nets
- 6. Cabuyería náutica - Nautical ropes
- 7. Pulpos, redes elásticas y correas de amarre - Stretch cords, tie-down straps & elastic nets
- 8. Cables, cadenas y accesorios - Wire ropes, chains and accessories

Rombull la solución Integral 360°

Rombull, the integral solution 360°

En Rombull somos **fabricantes, una empresa 360°** única en su concepción de **servicio total e integral, en continua evolución**. Orientada a satisfacer todas las necesidades de nuestros clientes, que les permita una gran ventaja competitiva al unificar en un **solo proveedor** las redes de seguridad, deporte, cordelería, mallas, pulpos, cables, cadenas, accesorios, etc. que puedan necesitar, e incluso creándole ad-hoc a su medida, productos que no estén en el catálogo.

Unos campos en el que no dejamos de innovar, creando nuevas líneas de productos como la reciente de **Cables, Cadenas y Accesorios** de acero de alta calidad o nuestra emergente sección de **Cordelería Natural**, que entronca con la sensibilidad ecológica del nuevo consumidor, sin olvidarnos de la equipación para **Parques de Aventura** que nos permite disfrutar con seguridad los deportes más intensos en el medio natural. Tres potentes familias de productos que cumplen las expectativas más exigentes, al estar diseñadas desde sus componentes, procesos y packaging, con la máxima calidad **"Made in Spain"** cumpliendo con la más estricta normativa y calidad europea. Todo para lograr la excelencia para usted.

Rombull's Factory is a company with a 360° philosophy that places the total and integral satisfaction of the needs of customers in the center of its activities. Our aim is to provide a great competitive advantage to our clients: Unifying in a single provider the procurement of safety nets, sport nets, industrial nets, shade nets, ropes, tie-down straps, wire ropes, chains and accessories. Rombull goes even beyond offering ad hoc solutions with articles that are not in our catalogue. We are constantly innovating, creating new product lines, such as our recent family of wire ropes, chains and accessories (made with high quality steel) and the section on natural ropes which addresses the environmental sensibility of new consumers. In this sense, Rombull has developed another new product category for adventure parks with articles that will allow users to practice intense sports in natural environments with the highest security standards. These new 3 brand extensions with products that fulfill the highest expectations of the most demanding customers, have been designed from its components, processes and packaging with the best quality "Made in Spain". Each article complies with the strict requirements set by European regulations and quality standards and Rombull achieves this level of excellence for you.

Valores **Rombull**

Rombull Core Values



Servicio Solucionamos las necesidades de nuestros clientes.
Service We solve the needs of our clients.



Calidad Contrastada, máxima del sector.
Quality Contrasted, the top in our sector.



Trabajo en equipo Actitud y aptitud orientada al cliente.
Teamwork Client oriented attitude and skills.



Innovación Nuevas ideas, procedimientos y productos.
Innovation New ideas, processes and products.



Confianza Basada en la coherencia y en la experiencia.
Trust Based on coherence and experience.



Ecología Respeto al medio ambiente.
Ecology Respect for the environment.

“ Rentable ”

Los lineales Rombull son la solución más inteligente para rentabilizar su espacio.

Profitable: Rombull linear plans are the smartest solution to increase profits in your selling space.

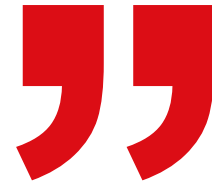

Cordelería, redes, mallas, complementos... son artículos imprescindibles para sus clientes y una importante fuente de ingresos.

El espacio, es uno de lo bienes más preciados de su establecimiento, rentabilizarlo con un lineal de una nueva gama de productos, imprescindibles para el consumidor y con una óptima exposición, es una de las mejores soluciones para hacerlo. Rombull, pone a su disposición su equipo de expertos, para lograrlo, y que usted cuente, rápidamente con un potente y práctico “Shop in Shop” un nuevo concepto de lineal adaptado 100% a su establecimiento. Le diseñamos, aprovechando al máximo su espacio disponible y seleccionando el surtido más adecuado para su tipo de cliente, para incrementar su rotación y ventas. Contamos con más de 6.500 referencias que cubren todas las necesidades del consumidor, profesional y doméstico con soluciones integrales de cordelería, redes, mallas, pulpos, cables y complementos.

Con información clara y un excelente packaging ayudamos al consumidor a elegir el producto más adecuado a su necesidad.

Ropes, nets, shade nets, accessories...
essential articles for your clients and a great source of income.

Space is one of the most valuable aspects of your store. Rombull provides solutions to increase the profitability of your linear space with a new product line that is essential to consumers and has an optimum presentation. Our team of experts is at your disposal to increase your sales rapidly with a powerful and practical concept “Shop in Shop” which adapts your linear space 100% to the needs of your shop. We will work on a specific design to increase sales and product rotation taking into account the maximum available space and the most suitable assortment according to your client profile. We have more than 6.500 references in our catalogue that cover all consumer needs in ropes, nets, bungees, wire ropes and accessories in the professional and DIY branches.

With clear information and excellent packaging, we help consumers to choose the most suitable product for their needs.



Usted pone el espacio, Rombull el proyecto

You provide the space, Rombull the project.

“Innovación”

En constante estudio para crear nuevas líneas de producto que se adapten a las necesidades cambiantes del mercado.

In constant study to create new product lines that adapt to the changing needs of the market.

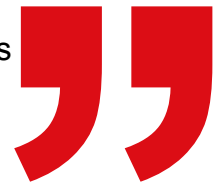

“6.500”

Referencias cubren todas las necesidades del consumidor, profesional y doméstico.

References that cover all the needs of professional and domestic consumers



“ 100%

Rombull es la única empresa especializada que cuenta con el 100% de soluciones integrales de cordelería, redes, mallas y complementos.

Rombull is the only specialized company that has 100% of the integral solutions required for ropes, nets and accessories.

”



“ 82%

De las decisiones de compra se toman frente al lineal. Rombull actualiza su negocio con potentes composiciones para aumentar la rentabilidad de su negocio.

Of the purchase decisions are taken in front of the sale space. Rombull updates your business with compositions that increase its profitability.

”

La calidad de ser fabricantes, reconocida mundialmente

The quality of being manufacturers
Worldwide known



Redes de seguridad, deporte e industria sin nudos, cordele-
ría profesional o bricolaje, mallas de sombreado, ocultación y
mosquiteras extraordinariamente duraderas y de fácil mon-
taje. Fabricadas con materia prima de primera calidad y alta
tecnología. En ROMBULL hemos ampliado nuestra oferta de
productos para cubrir todas las necesidades que demandan las
empresas. Contamos con el I+D+i más avanzado para la fabri-
cación de innovadores productos que cumplen con todas las
certificaciones de calidad europea.

Safety nets, sports and industry knotless and knotted nets, pro-
fessional and DIY ropes, shade nets and unravelling nets, extre-
mely lasting and easy to install. Manufactured with high quality
raw materials and technology. In ROMBULL we have widened
our product offer to fulfill cover all the needs demanded. Owning
the most advanced I+D+i for the manufacturing of new products
that accomplish all European quality certifications.

Respeto medioambiental y calidad certificada

Environmental care and certified quality

Sistema de gestión de calidad
UNE-EN ISO 9001:2015

System of quality management



Comprometidos con la eco-sostenibilidad y la excelencia, Rom-
bull ha unido la eficiencia profesional e industrial con el res-
peto medioambiental, logrando las certificaciones UNE EN ISO
14001:2015, 45001:2018 e ISO 9001:2015, normativas que
acreditan el cumplimiento de la compañía con las exigencias
relativas a dichos sistemas de gestión ambiental, gestión de la
salud, la seguridad, y compromiso con la calidad de servicio y
la satisfacción del cliente.

Así mismo, Rombull funciona bajo los parámetros de la certi-
ficación ISO 9001, norma de calidad que respalda la excelencia
en todos los procesos y servicios de la compañía, tanto pro-
ductivos como de gestión, al contar con un sistema de trabajo
avalado a nivel mundial y fundamentado en la mejora continua.

Rombull is committed to sustainable excellence, and is cons-
tantly seeking professional and industrial efficiency with envi-
ronmental respect. The company has obtained the certificates
UNE EN ISO 14001:2015, 45001:2018 and ISO 9001:2015
which accredit that the company complies with the high stan-
dards set by those management systems in environmental,
health and security management.

In addition, Rombull works under the strict parameters of the
certificate ISO 9001, a quality norm that encourages excellen-
ce in all production and management processes of our factory
and services provided by our teams. It is all endorsed by this
working system that is worldwide known for its continuous im-
provement process.



Sistema de gestión de seguridad y salud en el trabajo ISO 45001:2018

Safety management system
and occupational health



La adjudicación de la norma ISO 45001:2018, certifica el sistema de gestión de salud y seguridad en el trabajo seguido en Rombull, haciendo patente su óptima ejecución, su capacidad para identificar y reducir potenciales accidentes, y en general la mejora del rendimiento en la organización y estructura de la empresa.

The achievement of the ISO 45001:2018 norm, certifies the health and safety management work used in ROMBULL RONETS. Making clear the capacity to identify and reduce potential accidents. In a general vision the development and growth of the structure and organi-

Sistema de gestión ambiental UNE-EN ISO 14001:2015

Environmental management system



La concesión de la norma UNE EN ISO 14001:2015, es fruto de una auditoría que acredita el sistema de gestión medioambiental implantado y utilizado en Rombull, dando constancia de su responsabilidad social y ecológica. El sistema adoptado recoge, entre otras medidas, la optimización de la gestión de recursos y residuos, la reducción de los impactos ambientales negativos derivados de la actividad, y la reducción de los riesgos asociados a situaciones accidentales, avalando de esta forma un desempeño adecuado de la actividad con el fin de afectar lo menos posible al medio ambiente, y promover la preservación de la naturaleza.

The achievement of the UNE EN ISO 14001:2015 is due to an audit which proves the environmental management system used in ROMBULL. Making clear the company's philosophy of social care and responsibility. This system uses added to other ones, optimization of the sources and residual management system, reduction of the negative environmental impact and reduction of the risks associated to accidental situations. This way it is proved a correct development of the activity, with the objective of not affecting the environment and promoting environment preservation.

Sistema de gestión ambiental STANDARD 100 by OEKO-TEX

Environmental management system



La certificación OEKO-TEX 100 asegura que el uso de los productos no dejan sustancias nocivas en cantidades superiores a los límites previstos por el OEKO-TEX Standard 100, marca ecológica líder en el mundo para los artículos textiles. Rombull sigue siempre escrupulosamente todas las fases de producción del producto, con controles constantes de calidad, y usando materias primas certificadas.

The certificate OEKO-TEX 100 ensures that the use of products do not leave harmful chemicals in quantities above the limits set by the OEKO-TEX Standard 100. The OEKO-TEX Association is a worldwide leader entity in the testing of textile products. Rombull has put in place quality controls in all levels of the production and it employs certificated raw materials.

Máximo control de calidad

Maximum quality control

Las pruebas a las que sometemos nuestros productos a lo largo de todo su proceso de elaboración son supervisadas por personal altamente cualificado.

The tests which we submit our products to are supervised by highly qualified professionals through all of the process and manufacturing.



Test red Net test



Test cuerda Rope test



Test tencilla Braid test

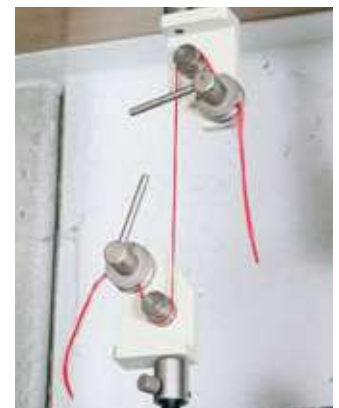

Test hilo Yarn test



Test malla Mesh test

REDES DE SEGURIDAD

SAFETY NETS



ROMBULL

Normativa Regulation

La NORMA EUROPEA EN 1263-1: 2002 establece los requisitos que debe reunir los tipos de redes de seguridad y protección según el uso que se hacen de las mismas.

The EUROPEAN REGULATION EN 1263-1: 2002 establishes the requirements that the different types of safety and protection nets must have, regarding the use of the nets.

Términos y condiciones Terms and conditions

MALLA: Serie de cuerdas organizadas en un modelo geométrico (rombos o cuadros) básico formando una red.

RED: Conexión de mallas.

TAMAÑO DE MALLA: Distancia entre dos nudos o conexiones de una cuerda de malla, medida de centro a centro de dichas conexiones.

RED DE SEGURIDAD: Red soportada por una cuerda perimetral u otros elementos de sujeción, o una combinación de ellos, diseñada para recoger personas que caigan desde cierta altura.

CUERDA DE MALLA: Cuerda con la cual están fabricadas las mallas de una red.

CUERDA PERIMETRAL: Cuerda que pasa a través de cada malla en los bordes de una red y determina las dimensiones de la red de seguridad.

CUERDA DE ATADO: Cuerda utilizada para atar la cuerda perimetral a un soporte adecuado.

CUERDA DE UNIÓN: Cuerda utilizada para unir varias redes de seguridad.

MALLA DE ENSAYO: Malla que se aloja en la red de seguridad para determinar el deterioro debido al envejecimiento y que puede retirarse sin alterar las prestaciones de la red.

ESTRUCTURA DE SOPORTE: Estructura a la cual las redes están sujetas y que contribuye a la absorción de la energía cinética en caso de acciones dinámicas.

CLASE: Clasificación de las redes respecto a su capacidad de absorción de energía y al tamaño de malla.

SISTEMA: Conjunto de componentes de las redes de seguridad que forman un equipo para utilizarlo de acuerdo con el manual de instrucciones.

MESH: Series of ropes organized in a basic geometric shape (Diamonds or squares) forming a net.

NET: Connection of meshes.

MESH SIZE: Distance between two knots or connections of a mesh rope, measured from centre to centre of those connections.

SAFETY NET: Net supported by a border rope or other supporting elements, designed to catch a falling person from heights.

MESH ROPE: Rope which the mesh of a net are manufactured from.

BORDER ROPE: Rope, which passes through each mesh at the perimeter of a net and determines the perimetric dimensions of the safety net.

TIE ROPE: Rope used to tie a border rope to a suitable support.

COUPLING ROPE: Rope used to join two or more safety nets.

MESH TEST: Mesh placed on the safety net to determine any deterioration due to the ageing and it can be removed without affecting the net performance.

SUPPORTING STRUCTURE: A structure where safety nets are secured and contribute to the absorption of the kinetic energy in case of dynamic actions.

CLASS: Net classification respective to its absorption capacity of energy and mesh size.

SYSTEM: A set of safety net components forming an equipment to be used in accordance with the instruction manual.

Clasificación redes Net classification

Tipo Type	Energía mínima de rotura Minimum breaking energy	Ancho máximo de malla Maximum mesh width
A1	$E_A = 2,3 \text{ kJ}$	$I_M = 60\text{mm}$
A2	$E_A = 2,3 \text{ kJ}$	$I_M = 100\text{mm}$

Tipo Type	Energía mínima de rotura Minimum breaking energy	Ancho máximo de malla Maximum mesh width
B1	$E_B = 4,4 \text{ kJ}$	$I_M = 60\text{mm}$
B2	$E_B = 4,4 \text{ kJ}$	$I_M = 100\text{mm}$

SISTEMA V System



- ▶ Red de seguridad con cuerda perimetral, para utilizar con horcas o pescantes.
Safety net with border rope, attached to a gallow type support.

SISTEMA S System

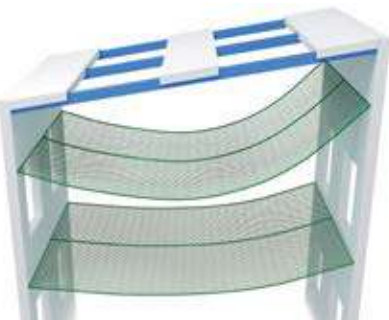

- ▶ Red de seguridad horizontal con cuerda perimetral.
Horizontal safety net with border rope.

SISTEMA U System

CLASE A CLASS

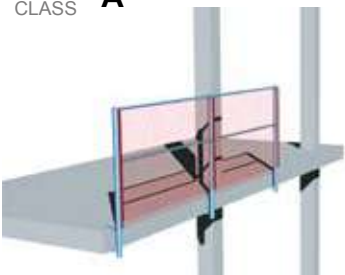

CLASE B CLASS

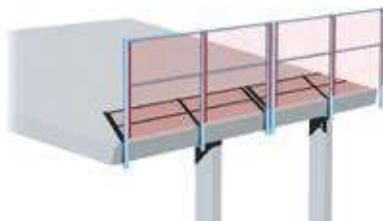

CLASE C CLASS

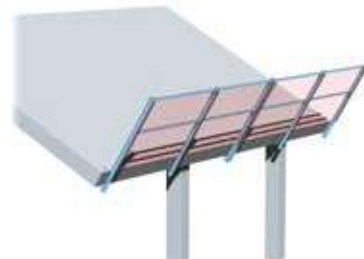

- ▶ Red de seguridad para protección lateral, barandillas o andamios.
Safety net for edge protection attached to brackets.

SISTEMA T System

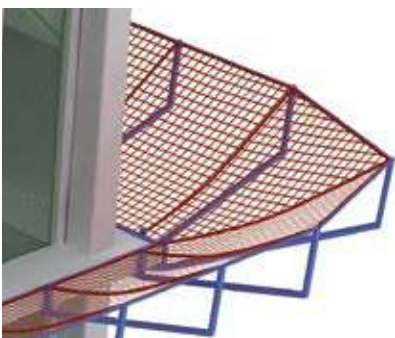

- ▶ Red de seguridad sujeta a consolas para su utilización horizontal.
Safety net tied to brackets for horizontal use.

Tipos de cuerdas Types of ropes

Tipo K/P: (Cuerda perimetral). Resistencia mínima a la tracción 30 kN (S) y 20 kN (V) respectivamente.

Type K / P: (Rope Edge). Minimum strength 30 kN tensile strength (S) and 20 kN (V) respectively.



Tipo L y F: (Cuerda de atado, con gaza uso sencillo, con un solo ramal de carga). Resistencia mínima a la tracción 30 kN (S) y 20 kN (V) respectivamente.

Type L and F: (rope tied with bright easy to use, with one branch of load). Minimum strength 30 kN tensile strength (S) and 20 kN (V) respectively.

Tipo R y H: (Cuerda de atado, con gaza uso doble, con dos ramales de carga). Resistencia mínima a la tracción 15 kN (S) y 10 kN (V) respectivamente.

Type R and H: (Rope tied double with loop, with two branches of charge). Minimum strength 15 kN tensile strength (S) and 10 kN (V) respectively.



Tipo N: (Cuerda de unión con gaza). Resistencia mínima a la tracción 7.5 kN Sistemas (S,T,U,V).

Type N: (rope with loop). Minimum tensile strength 7.5 kN Systems (S, T, U, V).



Tipo M y G: (Cuerda de atado, sin gaza uso sencillo, con un solo ramal de carga). Resistencia mínima a la tracción 30 kN (S) y 20 kN (V) respectivamente.

Type M and G: (rope tied without bright easy to use, with one branch of load). Minimum strength 30 kN tensile strength (S) and 20 kN (V) respectively.

Tipo Z y J: (Cuerda de atado, con gaza uso doble, con dos ramales de carga). Resistencia mínima a la tracción 15 kN (S) y 10 kN (V) respectivamente.

Type Z and J: (rope tied with bright double occupancy, with two branches of charge). Minimum strength 15 kN tensile strength (S) and 10 kN (V) respectively.



Tipo O: (Cuerda de unión con gaza). Resistencia mínima a la tracción 7.5 kN Sistemas (S,T,U,V).

*Los extremos de las cuerdas están protegidos para evitar el deshilachado.

Type O: (rope with loop). Minimum tensile strength 7.5 kN Systems (S, T, U, V).

*The end of the ropes are secured to avoid unraveling.

Tipos de cuerdas y mallas Ropes and mesh types

Denominación Denomination	Cuerda Rope			Resist. mín. a la tracción (kN) Minimum traction resistance					Sistema System	Notes Notes
	Sin extremos Without	Con gaza With bright	Sin gaza W / out	7,5	10	15	20	30		
F		x					x ^a		V	Cuerda de atado Tie Rope
G			x				x ^a		V	Cuerda de atado Tie Rope
H		x			x ^b				V	Cuerda de atado Tie Rope
J			x		x ^b				V	Cuerda de atado Tie Rope
K	x							x	S	Cuerda perimetral Border Rope
L		x						x ^a	S	Cuerda de atado Tie Rope
M			x					x ^a	S	Cuerda de atado Tie Rope
N		x		x					S, T, U, V	Cuerda de unión Coupling Rope
O			x	x					S, T, U, V	Cuerda de unión Coupling Rope
P	x						x		V	Cuerda perimetral Border Rope
R		x				x ^b			S	Cuerda de atado Tie Rope
Z			x			x ^b			S	Cuerda de atado Tie Rope



^a Si la red se sujeta con una cuerda con un ramal de carga.
If the net is attached with a single rope.

^b Si la red se sujeta con una cuerda con doble ramal de carga.
If the net is attached with a double rope.

Formación Training

En Rombull estamos preocupados por la correcta formación del personal en el montaje de sistemas de seguridad. Hemos desarrollado, cursos de formación teórico-prácticos, que preparan a los trabajadores en la correcta instalación de seguridad. En nuestro centro, se imparte formación a los equipos de trabajadores, que nuestros clientes asignan para el montaje de nuestros sistemas de seguridad colectivos. De esta forma aseguramos que son profesionales expertos en su correcto montaje. La formación consta de dos apartados:



- **Teórico** donde se desarrollan aspectos de la norma y teoría de los sistemas de seguridad y su mantenimiento.

- **Práctico** donde se realizan instalaciones reales, experimentando las mismas situaciones que se van a encontrar en su trabajo diario. El personal de las empresas que reciben nuestra formación, queda acreditado para el montaje de nuestros sistemas de seguridad. Esto permite, que nuestros sistemas de seguridad Rombull sea instalado de forma adecuada, según instrucciones de nuestros manuales de montaje y la formación recibida.

In Rombull Ronets, S.L. concerned about the correct way of staff training on how to install safety systems, so theoretical and practical courses have been developed, to form workers on the installing of our safety systems. In our premises we train worker teams assigned by some of our customers, on how to install our safety systems. This way we ensure that they become experts in the way of assembling this correctly.

The training course consists of two sections.

- Theoretical: Where theoretical aspect of the safety standards and maintenance are developed.
- Practical: Where real installations are made, experiencing the same situations found in the day to day's work. The trained staff is accredited for the installation of our safety systems. This allows our safety systems to be installed in the correct way, in accordance to our safety instructions manual, and the received training.

S.A.T. Servicio atención al cliente +34 966 758 130

S.A.T. Customer service + 34 966 758 130



Rombull pone a disposición de sus clientes su servicio técnico especializado, para responder a las dudas sobre instalación, normativa, uso y mantenimiento de su extensa gama de productos. El departamento de formación acredita a los operarios de las empresas de construcción e industria, sobre la correcta instalación y uso de los diferentes sistemas de redes de seguridad.

Rombull Ronets, S.L. offers his clients, a technical support service to answer questions about installing nets, regulations, use and maintenance of its extensive product range. The training department accredits building industry and industrial staff, about the correct way of installing and the use of the different safety net's systems.

La gama más completa de redes de seguridad

The most complete range of safety nets

Toda la seguridad que necesita su obra o proyecto. Le solucionamos cualquier requisito específico que se le plantee, incluso le fabricamos la red a medida.

All the security you need for your work or project. We will solve any specific needs that may arise, we also manufacture nets at any sizes.



**RED SIN NUDO
FÁCIL MONTAJE**
VARIEDADES DE MALLA, GROSOR Y COLOR
FABRICACIÓN PROPIA, REDES A MEDIDA

RED KNOT WITHOUT • EASY INSTALLATION
VARIETIES OF MESH, THICKNESSES AND COLORS
MANUFACTURED IN-HOUSE NETWORKS AS

SISTEMA T
System

PARAVIENTOS
Windscreen

ROMBULL

Somos fabricantes

We manufacture

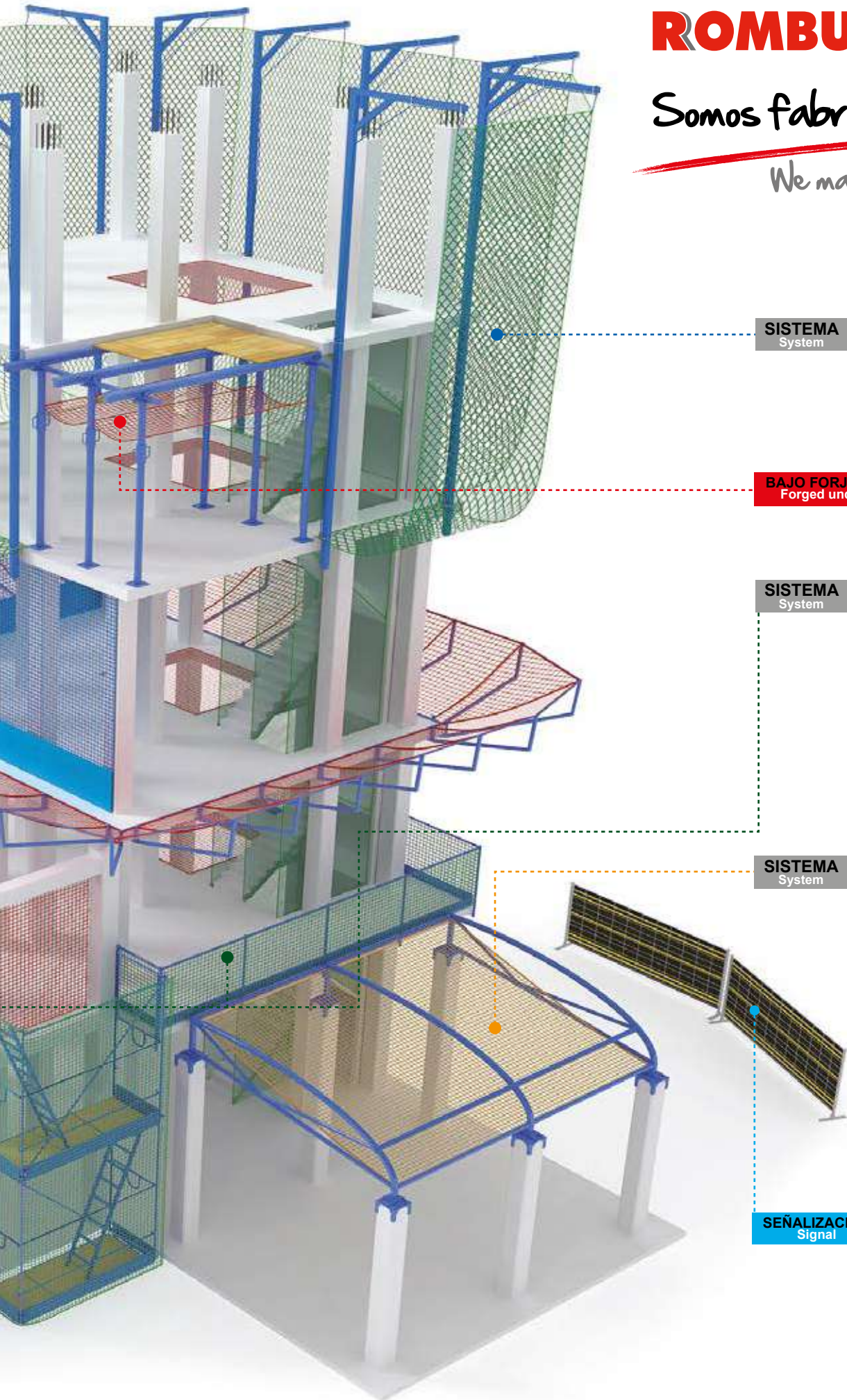

SISTEMA System **V**

BAJO FORJADO Forged under

SISTEMA System **U**

SISTEMA System **S**

SEÑALIZACIÓN Signal

Sistema V V System

Página 2 Tarifa. Page 2 Price List.

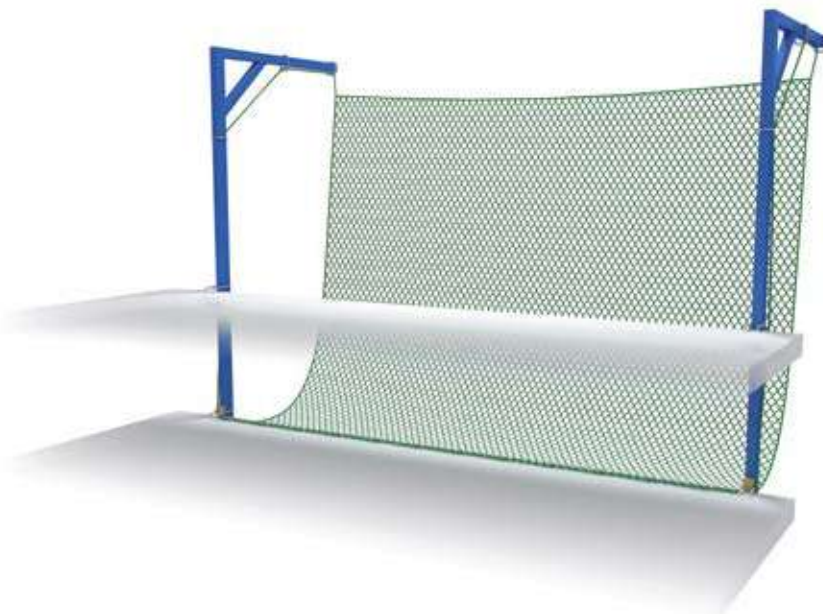

Red de seguridad con cuerda perimetral, para utilizar sujeta a un soporte tipo horca o pescante.

Safety net with border rope, to be help by gallows.

Redes sistema V poliamida Polyamide V system nets

Producto Product	Descripción Description	Color Color		
1012081101	M2 RED C/NUDO PA 4,5MM EN1263-1 VA2 D100 M			44
1022081101	M2 RED C/NUDO PA 4,5MM EN1263-1 VA2 Q100 M			44
1012081109	UD RED C/NUDO PA 4,5MM EN1263-1 VA2 D100 5X10 M			44
1012081111	UD RED C/NUDO PA 4,5MM EN1263-1 VA2 D100 7X10 M			44

Redes sistema V polipropileno Polypropylene V system nets

1011091109	UD RED S/NUDO PPM 5MM EN1263-1 VA2 D100 5X10 M	11	22	33	
1011091101	M2 RED S/NUDO PPM 5MM EN1263-1 VA2 D100 M	11	22	33	
1021091101	M2 RED S/NUDO PPM 5MM EN1263-1 VA2 Q100	11	22	33	

Cordelería Sistema V V system cords

4100100009	UD. CUERDA UNION PA TRENZ 06MM. EN-1263-1 B/100 M				44
4110140009	UD. CUERDA ATADO PES CABLE 10MM. EN-1263-1/100 M				44
4300140009	UD. CUERDA ATADO PA CABLE 10MM. EN-1263-1/100 M				44

Otras opciones disponibles consulte pag. 31 Other options available see pg. 31

Complementos Sistema V V system accessories

1120990001	M2 RED MOSQUITERA ENTRAMADO 6X6	11	22		44
1120990009	UD RED MOSQUITERA ENTRAMADO 6X6 5X10	11	22		
1141040309	UD RED ANTICASCOTE PPM 2,5MM M25 5X10				66
1141040301	M2 RED ANTICASCOTE PPM 2,5MM M25				66

Acabados redes Net finishes



1 Al rombo con orillado manual
1 Diamond mesh



4 Al cuadro con red anticascotes
4 Square mesh with overlay net



5 Al cuadro con mosquiteras
5 Square mesh with overlay debris net



Ensamblaje, montaje y desmontaje Assembly, erection and dismantling

► Ensamblaje de las horcas: Assembly of the gallows:

La horca es una estructura metálica que sirve de soporte a la red de seguridad del sistema V. Consta de dos tramos: cabeza y alargadera. Rombull Ronets, S.L. recomienda para un correcto funcionamiento del sistema el uso de horcas de 8 m (60x60x30). El ensamblaje de las horcas se realizará en la obra antes de ser instaladas.

Las horcas se instalarán una vez realizado el primer forjado (techo de planta baja) de la siguiente manera:

- Introducir la cabeza en el castillo de empalme de la alargadera, y fijar con tornillos de fijación y tuercas previstas por el fabricante de las horcas para este propósito.
- Para la instalación de anclajes, será necesario un plano de replanteo donde dejen indicados la ubicación de las omegas y de los ganchos de fijación necesarios para la colocación del sistema V.
- Las omegas se ajustarán a las dimensiones del zuncho perimetral, donde se va a introducir la alargadera de la horca.
- Para evitar que la Horca se gire, colocar la cuerda de atado en los extremos del ángulo superior de los pescantes y amarrar la cuerda al forjado formando un ángulo de 45°.

The gallows are a metal structure that support type V safety nets, it's composed of two sections, head and extension, Rombull Ronets recommends the use of 8 meter gallows. (60x60x30). The assembly of the gallows will be held on site prior to installation. The forks will be installed once the first cast (floor ceiling) as follows:

- Insert the head into the socket of the extension, and fix with screws and nuts provided by the manufacturer of the gallows for this purpose.
- For installation of the anchors, it's necessary a map indicating the location of the omega and the fixing hook, necessary for the placement of the system V.
- The omegas shall conform to the dimensions of the perimeter ring beam, which will introduce the extension of the gallows.
- To avoid the gallows turn, put the tie rope at the end of the upper corner of the gallows and tie the rope to the floor forming an angle of 45°.

► Instalación de la red tipo V: Nets installation V type:

- Una vez las horcas montadas, en el suelo se enhebrarán las cuerdas de atado (de unos 15 m aprox.) pasándolas por las anillas guía de la cabeza de los pescantes (horca), para evitar que se deslicen.
- Izar las horcas con ayuda de la grúa e introducir las horcas en las omegas del forjado de la planta baja y fijarlas introduciendo cuñas de madera en la omega del forjado para evitar que la horca se gire.
- En el mismo suelo del forjado de la planta baja, extender las redes.
- Amarrar las cuerdas de atado a las garzas de la red e izar las redes tirando de las cuerdas de atado.
- Una vez las redes estén en posición, atar las cuerdas de atado a las omegas del forjado, una vez que la red esté a un metro aprox. sobre la cota del plano de trabajo.

Para unir redes de seguridad, se unirá con cuerdas de unión de redes pasando malla por malla, en esta unión no deben existir distancias sin sujetar superiores a 100 mm. En la unión del sistema V el solape no está permitido. (figura 1).

- Once the gallows mounted on the ground tying the tied ropes (about 15 m approx.) by passing through the guide ring head of the gallows to prevent slipping.
- Hoist the gallows with help of the crane and introduce the gallows in the omegas of the ground floor and fix them by introducing wedges of wood in the omega floor ground to avoid the gallows turn.
- On the same floor of the slab ground floor, extend the nets.
- The tied ropes to the herons of the net and hoist the nets by pulling the tied rope.
- Once the nets are placed, tie the tied ropes to the forged omegas, once the net is approximately 1 meter over the working level. To join safety nets, they will be joined with net coupling ropes passing mesh by mesh, in this joining cannot be any non-holding distance greater than 100 mm. At the joint of the system V the overlap is not allowed. (Figure 1).

► Ejemplo de montaje: Mounting example:

- Extender las redes en el suelo y coser con cuerda de unión de tal manera que no existan distancias mayores de 100 mm. sin sujetar dentro del área de la red.
- Para ajustar las redes, pasar las cuerdas de atado por cada una de las mallas, y atar los extremos de las cuerdas de división a las cuerdas perimetrales.
- Izar los paños, ya ajustados a las dimensiones de la obra, y atarlos por su cuerda perimetral a los determinados puntos de anclaje, o elementos de la estructura. (la distancia entre puntos de anclaje debe ser menor de 0,5 m).

Nota: Para efectuar el montaje de la redes es imprescindible el uso del arnés de seguridad.

- Spread the nets on the ground and sew the coupling ropes so that there are no gaps greater than 100 mm within the netted area.
- To adjust the net, pass the coupling rope through each one of the meshes, and tie them through the border rope.
- Lift the nets, already adjusted to the dimensions of the construction site and tie them through their perimeter cord to the certain anchoring points or the elements of the structure. (the distance between anchor points must be less than 0,5 m).

Note: To carry out the installation of safety nets type it's essential to use a safety harness and lanyard.

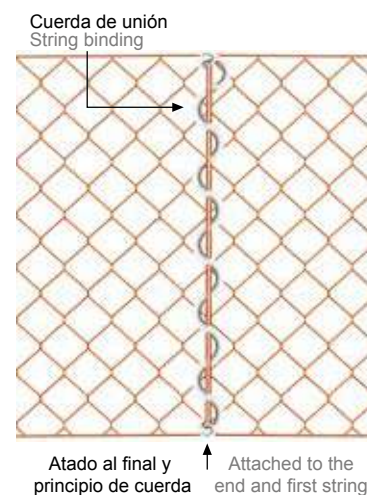

Replanteo de horcas en esquinas: Stake corners gallows:

- El borde superior de la red deberá estar, como mínimo, a 1 m por encima del área de trabajo.
- Las redes, deberán unirse unas a otras con cuerda de unión para no dejar ningún hueco. No está permitido solapar. (Figura 1)
- Las redes de seguridad deben ser instaladas lo más cerca posible por debajo del nivel de trabajo. Las alturas de caída H_i y H_e no excederán los 6,0 m. (Figura 2).

- The top edge of the nets must be at least 1 m above the work area.
- The nets must be attached to each other with coupling rope leaving no gaps. (Figure 1)
- Safety nets should be installed as close as possible below the level of work. The drop heights H_i and H_e will not exceed 6.0 m. (Figure 2).

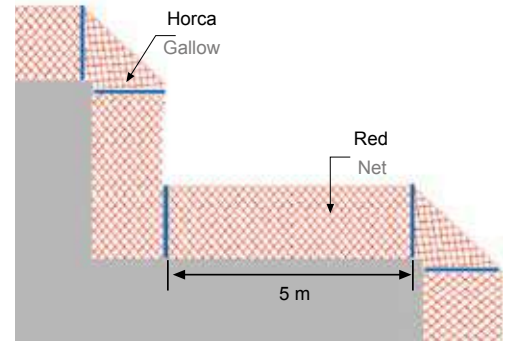

Alturas de caída: (H_i , H_e , H_r) Drop height (H_i , H_e , H_r)

- Altura de caída H_i es la distancia vertical entre la red de seguridad y el punto de trabajo superior. (figura 2).
- Altura de caída H_e es la distancia vertical entre la red de seguridad y el punto de trabajo superior, en el borde del área de trabajo. (figura 2).
- Altura de caída H_r es la distancia vertical entre la red de seguridad y el punto de trabajo superior, a una distancia horizontal de 2 m desde los puntos de anclaje. (figura 2).
- Posición del borde superior de la red de seguridad H_n . El borde superior de la red debe quedar por encima del plano de trabajo. (figura 2).

- Drop height H_i is the vertical distance between the safety net and the point of superior work. (Figure 2).
- Drop height H_e is the vertical distance between the safety net and higher working point on the edge of the workspace. (Figure 2).
- The drop height H_r is the vertical distance between the safety net and the higher working point, at a horizontal distance of 2 meters from the anchoring points.
- Position of the upper edge of the safety net H_n . The upper edge of the net must be above the working level.

Figura 1
Figure 1

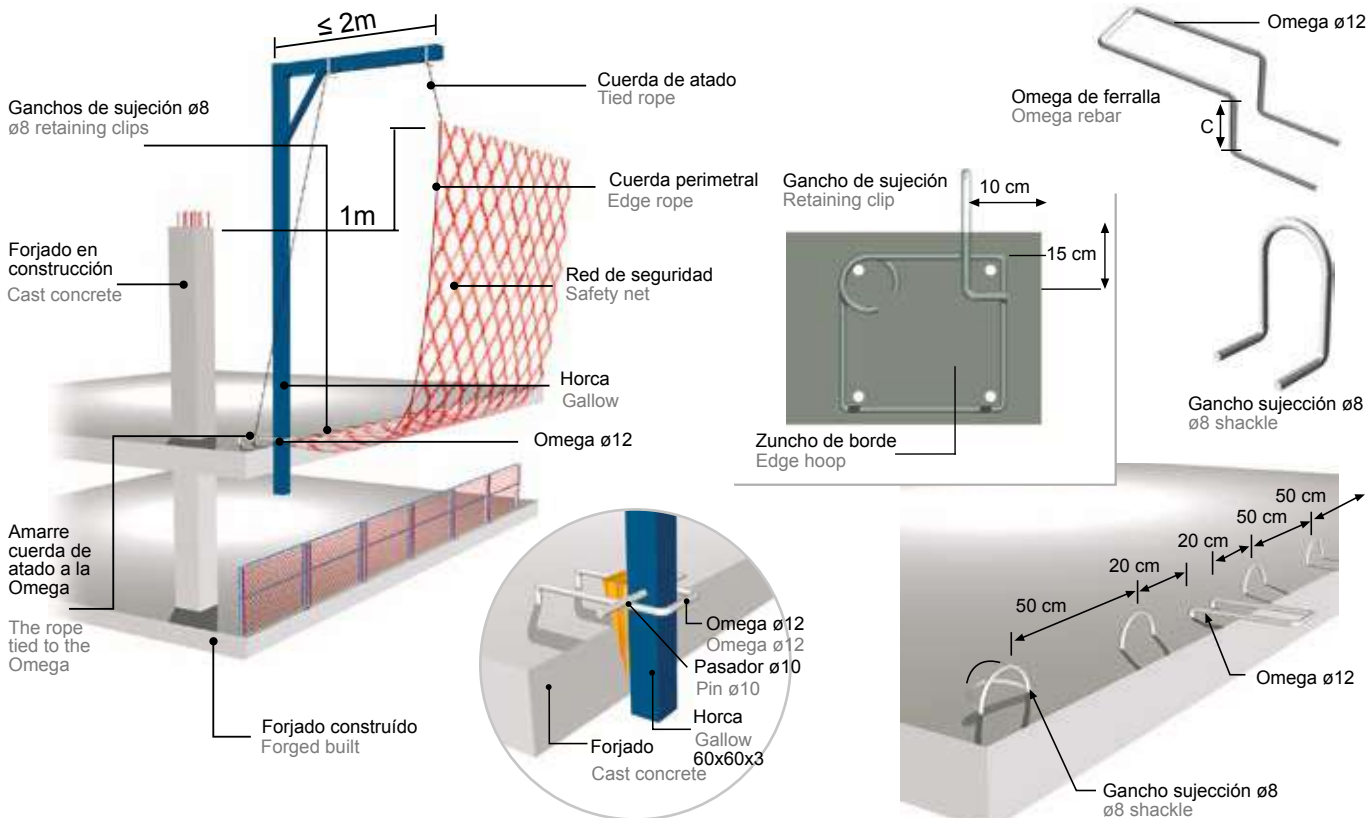
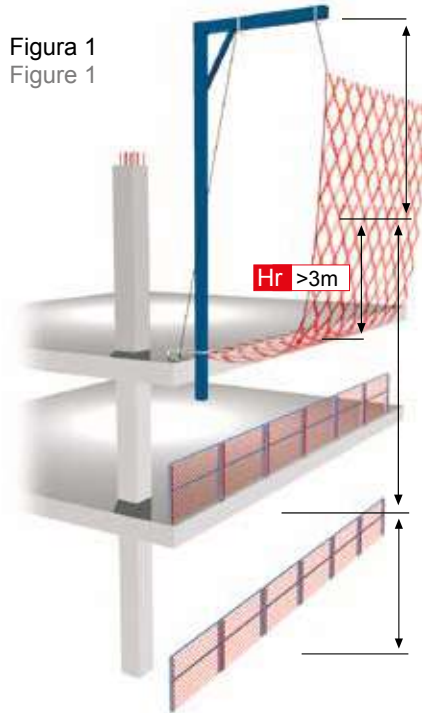

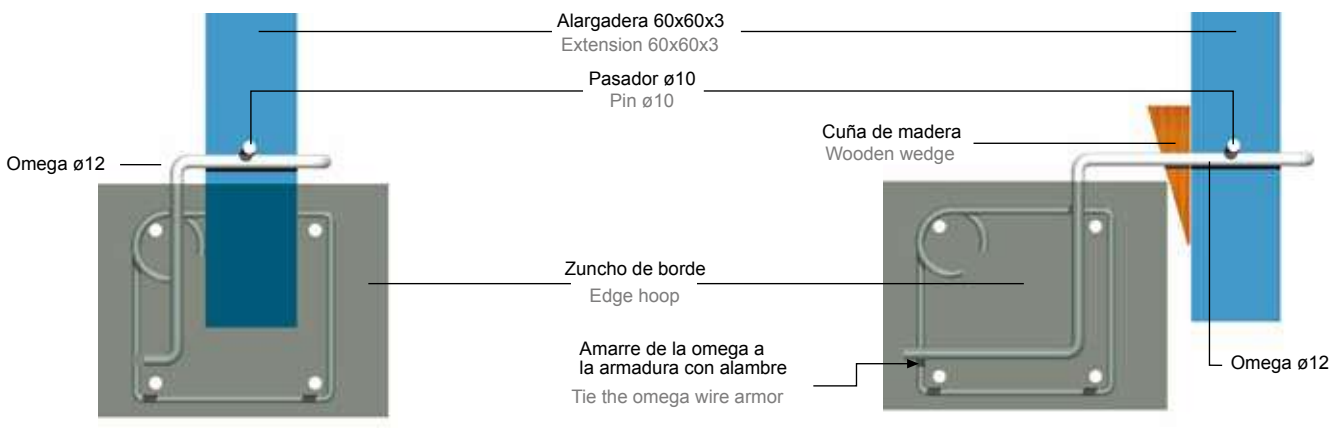

Izado de las horcas una vez terminada una planta **Lifting the gallows once completed a plant**

Paso 1

- Colocación de la barandilla en el borde de los forjados: (A) Forjado donde está amarrada la red y donde se encuentra el anclaje intermedio de la horca. (B) Último forjado protegido y al cual se va a subir la red. (S) Forjado donde está sujeta la parte extrema de la horca. (se sugiere el de tipo embutido).

Paso 2

- Enganche de la horca con eslinga (por la parte inferior de la escuadra).
- Retirada del anclaje en nivel (S), y acuñamientos en forjado (A). Para traslados sucesivos hablaríamos de pasado en (A) y acuñamiento en (B).
- Soltando de la cuerda de maniobra de la red, quedando sujeta del operario situado en forjado (A).

Paso 3

- Izado del soporte mediante el auxilio de la grúa.
 - A medida que sube la horca, el trabajador en forjado (A) va alargando la cuerda de maniobra.
 - Colocación del pasador en (A).
 - Acuñamiento de la horca en (A) y (B).

Paso 4

- Deslingado.
- Izado de la red. El trabajador en (B), coge la cuerda de maniobra mientras que el trabajador en (A) procede a la liberación de los anclajes de la red.

Paso 5

- El trabajador en (B) iza la red hasta la altura deseada.
- Anclaje de la red a borde del forjado (B). Y así sucesivamente, forjado a forjado.
- Es recomendable que se trasladen al nivel siguiente antes de ejecutar pilares de la última planta protegida.

Step 1

- Install edge protection to the floor: (A) Cast concrete where the net is tethered and where the intermediate anchor gallows are found. (B) Last forged protected and which the network will go up to. (S) Forged where the external part of the gallows is attached. (suggest the X type).

Step 2

- Hook the gallows with sling (at the bottom of the bracket).
- Remove the anchor at level (S) and cradled in forged (A). For successive transfers we would talk about PIN (A) and wedging in (B).
- Letting go of the maneuver rope of the net, being attached to the operator located in the forged (A).

Step 3

- Lifting of the support by the help of the crane.
 - As the gallows are lifting up, the worker in forged (A) is releasing the rope of maneuver.
 - Placement of the PIN in (A).
 - Wedging the gallows in (A) and (B).

Step 4

- Dismantling.
- Lifting of the nets. The worker at (B) takes the rope to maneuver while the worker in (A) releases the net anchors.

Step 5

- The worker in (B) raises the net to the desired height.
- Anchoring of net to the slab edge (B). And so on,
- We recommend moving the nets to the next level before starting with the pillars of the last protected floor.



Redes horizontales y de protección de borde

Horizontal nets and edge protection



SISTEMA
System **U**

Red de seguridad para protección lateral:
NORMA EN 1263-1, como complemento
ideal a las barandillas NORMA EN 13374.

Safety net for edge protection:
NORM EN 1263-1, an ideal complement
to the guardrails NORM EN 13374.

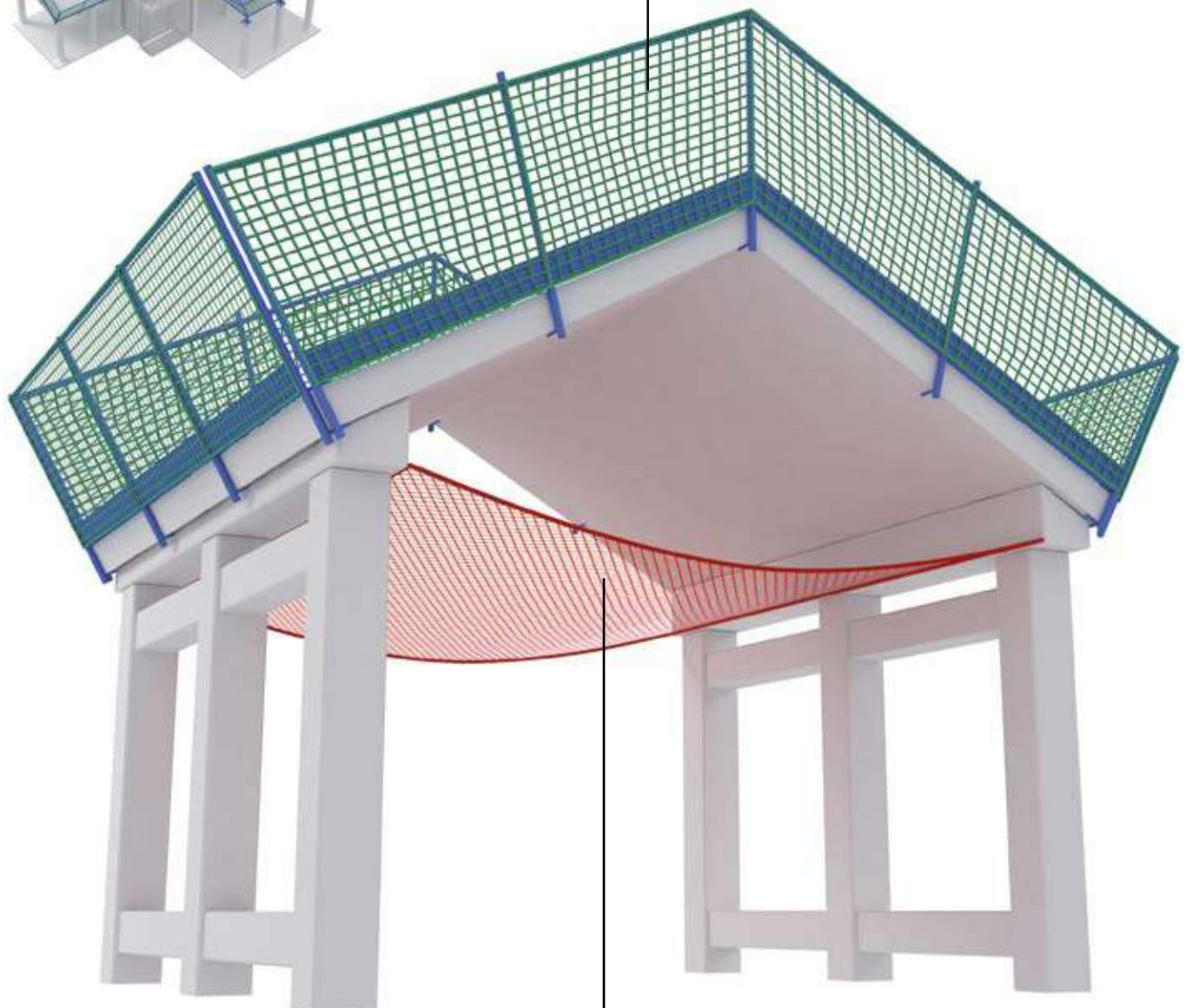

SISTEMA
System **S**

Red de seguridad horizontal con cuerda
perimetral, destinada a parar la caída de
personas y objetos de niveles superiores.

Horizontal safety net with border rope,
designed to stop falling objects and persons
from upper levels.

Sistema S S System

Página 2 Tarifa. Page 2 Price List.



Figura 2
Figura 2



Red de seguridad para protección lateral:
NORMA EN 1263-1, como complemento
ideal a las barandillas NORMA EN 13374.

Safety net for edge protection:
NORM EN 1263-1, an ideal complement
to the guardrails NORM EN 13374.

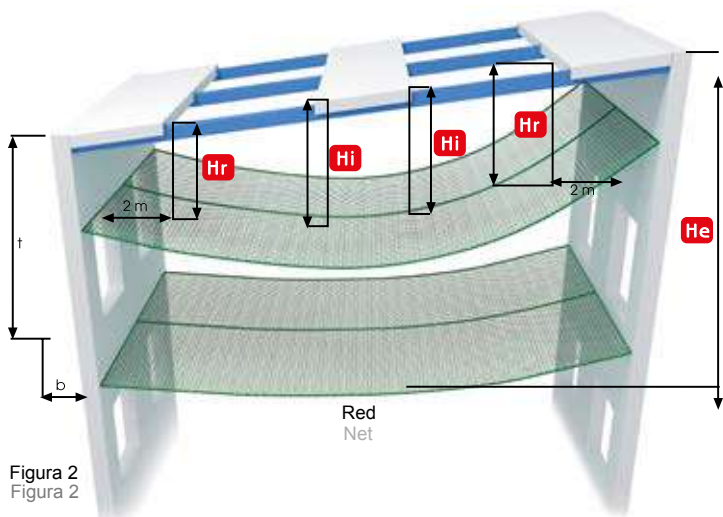
Redes sistema S poliamida Polyamide S system nets

Producto Product	Descripción Description	Color Color
1032081101	M2 RED C/NUDO PA 4,5MM EN1263-1 SA2 D100 M	44
1062091101	M2 RED C/NUDO PA 6MM EN1263-1 SB2 Q100 M	44
1042081101	M2 RED C/NUDO PA 4,5MM EN1263-1 SA2 Q100 M	44

Redes sistema S polipropileno Polypropylene S system nets

1031091101	M2 RED S/NUDO PPM 5MM EN1263-1 SA2 D100 M	11	22	33	44
1041091101	M2 RED S/NUDO PPM 5MM EN1263-1 SA2 Q100 M	11	22	33	44
1041091109	M2 RED S/NUDO PPM 5MM EN1263-1 SA2 Q100 5X10 M	11	22	33	44
1041091110	UD RED S/NUDO PPM 5MM EN1263-1 SA2 Q100 6X10 M	11	22	33	44
1041091122	UD RED S/NUDO PPM 5MM EN1263-1 SA2 Q100 7,5X10 M	11	22	33	44
1041091118	UD RED S/NUDO PPM 5MM EN1263-1 SA2 Q100 7,5X15 M	11	22	33	44
1041091119	UD RED S/NUDO PPM 5MM EN1263-1 SA2 Q100 10X10 M	11	22	33	44
1041091114	UD RED S/NUDO PPM 5MM EN1263-1 SA2 Q100 11X16 M	11	22	33	44

Cordelería Sistema S S system cords

4100100009	UD.CUERDA UNION PA TRENZ 6MM EN-1263-1 B/100 M				44
4792120014	UD.CUERDA PES TRENZ. 8MM EN-1263-1 500 M				44
4110170009	UD.CUERDA ATADO PES CABLE 14MM EN-1263-1 100 M				44

Otras opciones disponibles consulte pag. 31 Other options available see pg. 31

Complementos Sistema S S system accessories

1120990001	M2 RED MOSQUITERA ENTRAMADO 6X6	11	22		44
1141040301	M2 RED ANTICASCOTE PPM 2,5MM M25	11			
1110170003	UD. GUARDACABO EN GAZA				

Acabados redes Net finishes



2 Al cuadro
2 Square mesh



3 Al cuadro con guardacabo en Gaza
3 Square mesh net with reinforced loops



4 Al cuadro con red anticascotes
4 Square mesh with overlay net



5 Al cuadro con mosquiteras
5 Square mesh with overlay debris net

Este sistema de redes de tipo S se utiliza en la construcción de naves industriales, viaductos, puentes, pasos elevados, etc., habitualmente se confeccionan a medida, según el área de trabajo que se haya de cubrir. Para la instalación de las redes se deberá tener en cuenta los siguientes parámetros:

This "S" type net system is used for industrial buildings on construction sites, bridges, etc., and can be made at any size depending on the area to be covered.

For the safety nets installation the following parameters will be taken into account:

Alturas de Caída: (Hi , He , Hr)

- Altura de caída " Hi " es la distancia vertical entre la red de seguridad y el punto de trabajo superior. (figura 2)
- Altura de caída " He " es la distancia vertical entre la red de seguridad y el punto de trabajo superior, en el borde del área de trabajo. (figura 2)
- Altura de caída " Hr " es la distancia vertical entre la red de seguridad y el punto de trabajo superior, a una distancia horizontal de 2,0 m desde los puntos de anclaje. (figura 2)

Falling heights: (Hi , He , Hr)

- Falling heights " Hi " is the vertical distance between the safety net and the highest working level. (Figure 2)
- Falling heights " He " is the vertical distance between the safety net and the highest working level, in the border of the working area. (figure 2)
- Falling heights " Hr " is the vertical distance between the safety net and the superior working point, at a horizontal distance of 2 mts. from the anchoring points. (Figure 2)

Anchura de recogida:

La anchura de recogida "b" es la distancia horizontal entre el borde del área de trabajo y el borde de la red de seguridad. Dependiendo de la altura de caída, la anchura de recogida "b" de la red no será inferior a los siguientes valores:

- Las redes de seguridad deben ser instaladas lo más cerca posible por debajo del nivel de trabajo. Las alturas de caída Hi y He no excederán los 6 m. Véanse las figuras 1 y 2.
- Si el puesto de trabajo se encuentra sobre una superficie con una inclinación superior a 20°, la anchura de recogida "b" será al menos de 3 m. La distancia "t" entre el punto de trabajo en el extremo y el punto más bajo del borde de la red de seguridad no excederá los 3 m. (figura 3)

Catching width:

The catching width "b" is the horizontal distance between the edge of the working area and the edge of the safety net. Depending on the falling height, the net's catching width "b" will not be less than the following values:

- The safety nets should be installed as close as possible to the underside of the working level. The falling heights Hi and He will not exceed 6,0 m. See figures 1 and 2.
- If the working area is on a surface with an inclination greater than 20°, the catching width "b" will be less than 3,0 m. The distance "t" between the working point in its ends and the lowest point of the edge of the safety net will not exceed 3 m. (figure 3)

Altura de caída He Falling height He	≤ 1 m	≤ 3 m	≤ 6 m
Anchura de recogida Catching width	≥ 2 m	≥ 2,5 m	≥ 3 m



Figura 3
Figure 3

Tamaño de la red de seguridad tipo S:

Para la instalación de redes de seguridad de tipo S, el tamaño mínimo de la red será de al menos 35 m². Para las redes rectangulares, la longitud del lado menor será como mínimo de 5 m.

Nota: las redes de seguridad pequeñas (menores de 35 m² y con un lado menor de 5 m) podrían ser especificadas por Normas Nacionales.

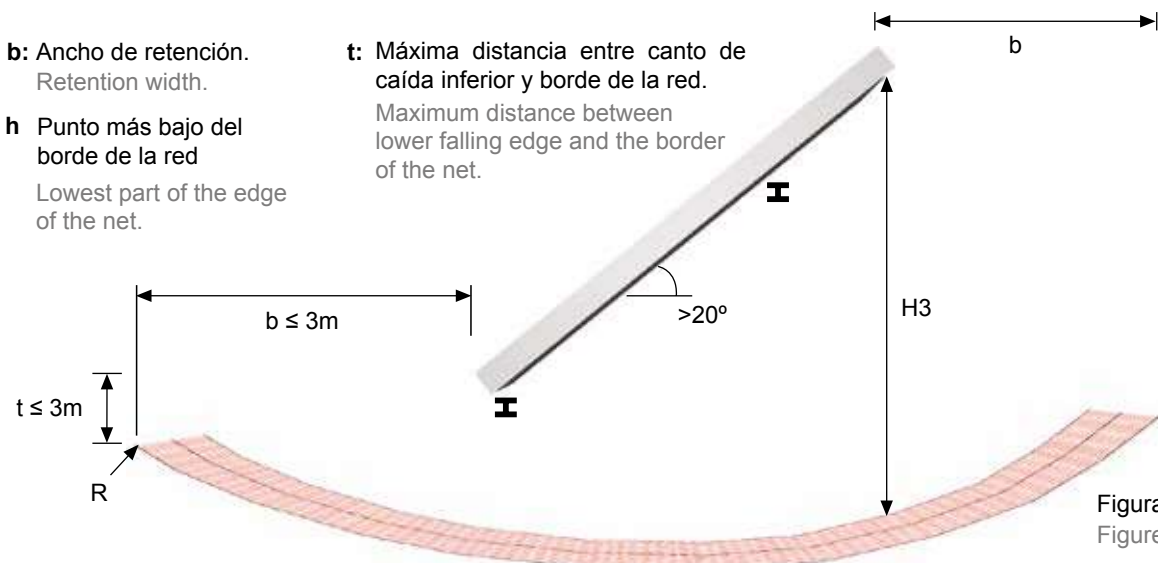
Size of the type S:

For the type S installation, the minimum size of the net will be at least 35 m². For the rectangular nets, the length of the smallest side will be at least 5 mts.

Note: the small safety nets (smaller than 35 m² and with a smaller side of 5 mts.) Should be specified by National Standards.

Instalación:

Las redes de seguridad de tipo S, se instalan con cuerda de atado a puntos de anclaje capaces de resistir la carga característica. La distancia entre puntos de anclaje debe ser inferior a 2,5 m. Para calcular cada punto de anclaje, la carga característica P utilizada, será al menos de 6 kN, para una altura de caída de 6 m.

Installation:

The type S, are installed with a tied rope to the anchorage points capable of resisting the characteristic load. The distance anchorage points must be less than 2,5 mts. To calculate each anchorage point, the characteristic load P used, will be at least 6 KN, for a fallen of 6 mts. height .

Unión:

Para unir redes de seguridad, se unirá con cuerdas de unión de redes pasando malla por malla, en esta unión no deben existir distancias sin sujetar superiores a 100 mm. En caso de unión de redes tipo S, por solapado, el mínimo de solape será 2 m (figura 1a y 1b).

Joining:

To join safety nets by passing coupling ropes through each mesh to ensure no gaps greater than 100 mm are created. In case of S type, by overlapping, the minimum overlap will be 2 mts. (Figure 1a and 1b).

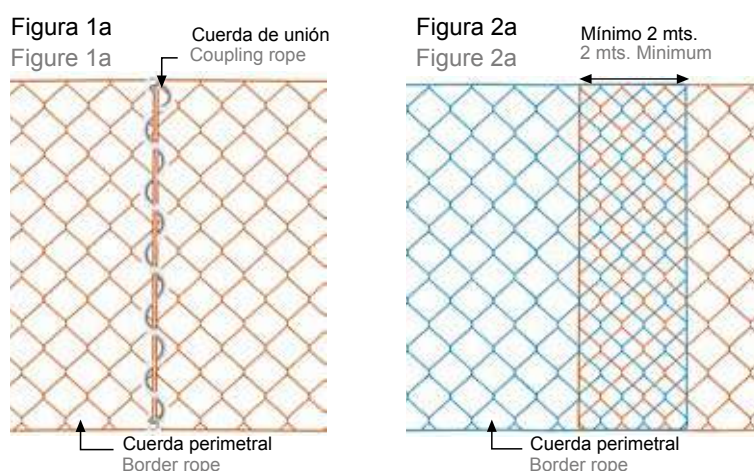

Hay dos formas para el montaje de la red de tipo S:

a) En el suelo:

Extender las redes en el suelo y coser con cuerda de unión de tal manera que no existan distancias mayores de 100 mm. Sin sujetar dentro del área de la red. Ajustar las redes, pasar las cuerdas de atado por cada una de las mallas, y atar los extremos de las cuerdas de división a las cuerdas perimetrales. Izar los paños, ya ajustados a las de la obra y atarlos por su cuerda perimetral a los determinados puntos de anclaje, o elementos de la estructura. (la distancia entre puntos de anclaje debe ser menor de 2,5 m).

b) Elevadas:

Izar los paños, ya ajustados a las dimensiones de la obra, y atarlos por su cuerda perimetral a los determinados puntos de anclaje o elementos de la estructura. (La distancia entre puntos de anclaje debe ser menor de 2,5 m). Una vez las redes se encuentren elevadas y sujetas a los puntos de anclaje, se procederá a la unión de los paños con cuerda de cosido pasándola malla por malla y haciendo nudos cada 2 o 3 mallas, para que entre paño y paño no quede abertura de más de 100 mm. Por último, pasar las cuerdas de atado por cada una de las mallas y atar los extremos de las cuerdas de división a las cuerdas perimetrales.

Nota: Para efectuar el montaje de la redes es imprescindible el uso del arnés de seguridad.

There are two ways to assemble the type S net:

a) On the floor:

Spread the nets on the floor and lace the coupling rope in a way that there cannot be any gaps greater than 100 mm. inside the netted area. Adjust the nets, pass the tied ropes through each of the meshes, and tie the ends of the coupling ropes to the border ropes.

Raise the nettings, already adjusted to the dimensions of the construction site, and tie them through their border rope to the determined anchorage points, or the elements of the structure. (The distance between anchorage points must be less than 2,5 mts.).

b) Elevated:

Raise the nets and tie them through their border rope to the structure at less than 2,5 m centers. Once the nets are elevated and tied to the anchorage points, join them with coupling rope passing through each mesh.

Sistema U U System

Red de seguridad para protección lateral NORMA EN 1263-1
Safety net for side protection NORM EN 1263-1

Página 3 Tarifa. Page 3 Price List.

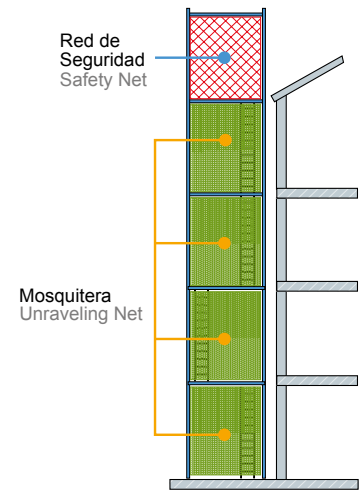
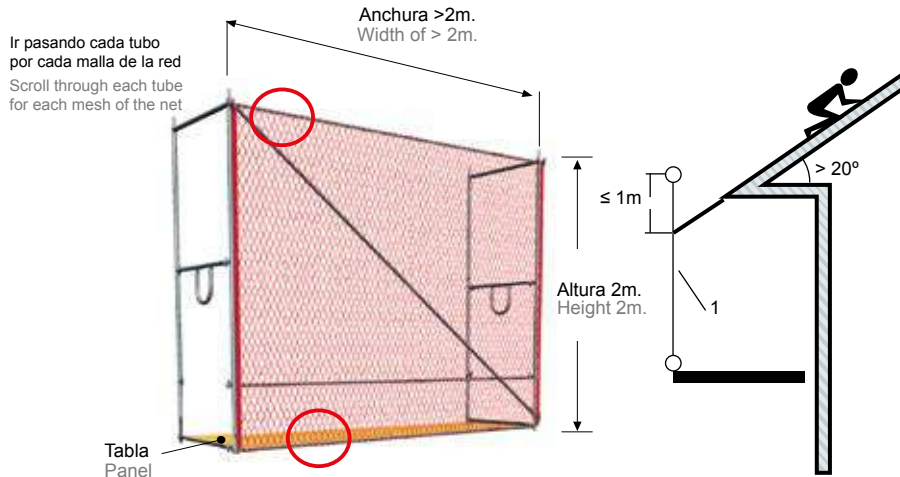

Redes sistema U poliamida Polyamide U system nets

Producto Product	Descripción Description	Color Color		
1082081101	M2 RED C/NUDO PA 4,5MM EN1263-1 UA2 Q100			44

Redes sistema U polipropileno Polypropylene U system nets

1081091101	M2 RED S/NUDO PPM 5MM EN1263-1 UA2 Q100 M	11	22	33	44
1081090701	M2 RED S/NUDO PPM 5MM EN1263-1 UA2 Q45 M	11	22	33	44
1081090901	M2 RED S/NUDO PPM 5MM EN1263-1 UA2 Q60 M	11	22	33	44
1081091110	UD. RED S/NUDO PPM 5MM EN1263-1 UA2 Q100 1,5X10 M	11	22	33	44
1081091106	UD. RED S/NUDO PPM 5MM EN1263-1 UA2 Q100 2X10 M	11	22	33	44
1081091123	UD. RED S/NUDO PPM 5MM EN1263-1 UA2 Q100 3X10 M	11	22	33	44
1081091125	UD. RED S/NUDO PPM 5MM EN1263-1 UA2 Q100 3,5X10 M	11	22	33	44
1081091114	UD. RED S/NUDO PPM 5MM EN1263-1 UA2 Q100 3X20 M	11	22	33	44

Cordelería sistema U U system cords

4100100009	UD.CUERDA UNION PA TRENZ 06MM. EN-1263-1 B/100 M				44
------------	--	--	--	--	----

Complementos sistema U U system accessories

1120990029	M2 RED MOSQUITERA ENTRAMADO 6X6 ADH	11	22		44
3240000003	UD. CIERRE GSV	11	22	33	
1120990062	MTL. RED PLINTO MOSQUITERA ENTR. 6X6 0,5 ALTO				44



Montaje de la red Tipo U Las redes tipo U se utilizan para la protección lateral de andamios. Las redes se instalarán en posición vertical, procediendo a pasar el tubo del andamio por cada una de las mallas.

Cumpliendo estas instrucciones el andamiaje está conforme a la norma EN-12811.

Type U net assembly This system U is used with scaffolding of lateral scaffolds. The nets will be installed in vertical position, with the scaffolding tubes passing through all the meshes.

Meeting these guidelines is subject to the scaffolding EN-12 811.

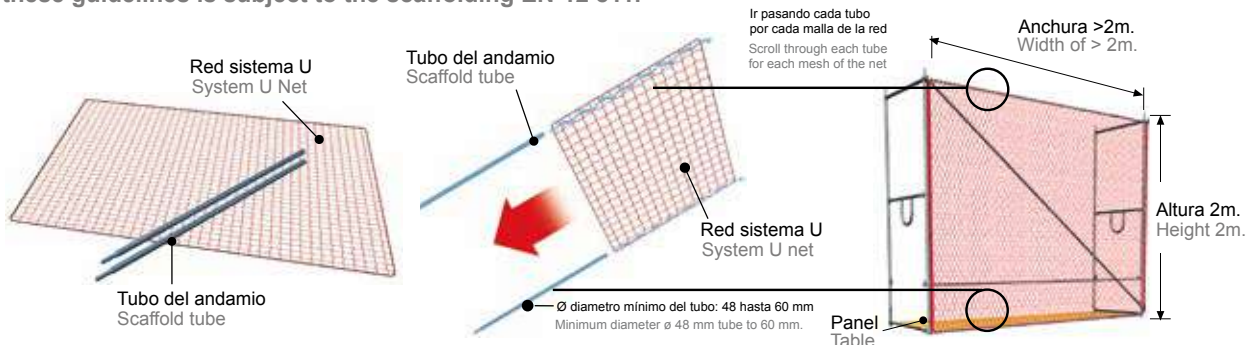

Preparar la red junto con los tubos del andamio que se va a montar.
Prepare the net with the scaffold tubes that is going to be assembled.

El marco y el andamiaje debe estar dimensionado o probado para soportar el peso de una persona cuando caiga en la red.
Pass the scaffold tubes through all the meshes.

El terreno o la estructura en la que el marco o el andamio se monte, debe soportar los pesos (mencionados anteriormente).
Once the scaffold tubes are assembled, the net will be in tension as the picture shows.

Red de seguridad para protección lateral, en barandillas o andamios. Sistemas provisionales de protección de borde NORMA UNE-EN 13374:

Safety net for side protection, guardrails or scaffolds.
Provisional systems for side protection NORM UNE-EN 13374:

Sistemas provisionales de protección de borde, construcción o mantenimiento de edificios y otras estructuras para superficies planas o inclinadas.

Temporary systems for edge protection, construction or maintenance of buildings and other structures for flat or sloping surfaces.

Normativa Regulation

Norma Europea UNE-EN 13374 sobre sistemas provisionales de protección de borde.
European Regulation UNE-EN 13374 on temporary systems for side protection.

Términos y definiciones

Sistema de protección de borde: Conjunto de componentes destinados a proteger a las personas contra las caídas a un nivel inferior y retener materiales.

Protección intermedia: Barrera de protección formada (por ejemplo, con una estructura de mallazo o una red de seguridad) entre la barandilla y la superficie de trabajo.

Plinto o rodapié: Elemento vertical específicamente previsto para prevenir la caída o deslizamiento de materiales o personas fuera de una superficie.

Redes: Las redes de seguridad utilizadas como protección lateral deben ser de tipo U, de acuerdo con la Norma EN 1263-1.

Terms and definitions

Edge protection system: Set of components designed to protect persons from falling at a low level and retain materials.

Intermediate protection: Protection barrier formed (for example, with a structure of rebar reinforcement or a safety net) between the guardrail and the surface of work.

Plinth or skirting toe board: Vertical element specifically designed to prevent the fall or slide of materials or persons out of a surface.

Net: The safety net used as side protection must be type U, in accordance with the Standard EN 1263-1.

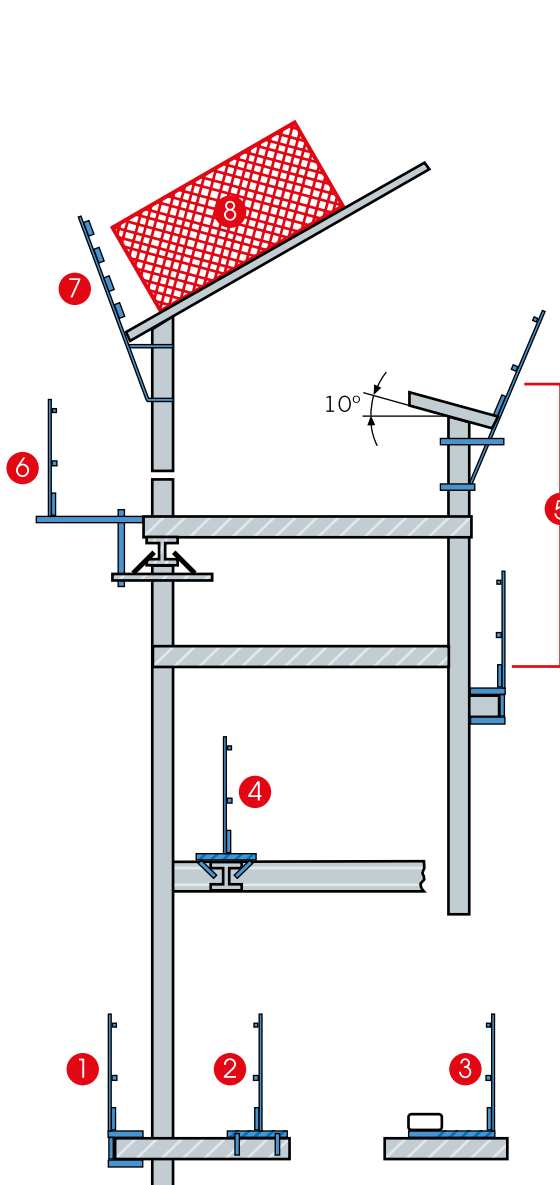

- 1 Sistema de mordazas para forjados (sargentos).
System for fixing to concrete slab.
- 2 Sistema fijado al suelo.
System fixed to the floor.
- 3 Sistema contrapesado.
Counterweight system.
- 4 Sistema de mordaza para el ala superior de la viga.
System for the top flange of the beam.
- 5 Sistema de mordaza para columnas, forjados y cubiertas horizontales.
Bracket system for columns, framework and horizontal covering.
- 6 Mordaza para el ala inferior de una viga.
Gag for the lower wing of the beam.
- 7 Sistemas de mordaza para columnas cubiertas inclinadas.
Bracket system for inclined surfaces.
- 8 Sistema tipo mallazo.
System type rebar reinforcement.

Los sistemas de protección de borde pueden ser empleados en una amplia variedad de situaciones gracias a sus múltiples métodos de colocación. Su gran diversidad de fijaciones y componentes intermedios permite que este sistema pueda situarse en diferentes cubiertas y estructuras, con diferentes separaciones de vigas, incluso antes de que el perímetro se encuentre montado en su totalidad. Este sistema cuenta con múltiples soluciones para el cerramiento de las esquinas, al tiempo que el acceso por el mismo puede realizarse a través de puntos determinados, mediante el uso de escaleras o plataformas elevadoras.

Sistemas de protección de borde: Requisitos generales.

La altura desde la parte más alta de la protección de borde ha de ser al menos 1 m. Máximas aperturas: La protección de borde debe de estar diseñada de tal manera que retenga una esfera de un determinado diámetro.

The side protection systems can be used in a wide range of applications due to their its multiple methods of installation. Their range of anchorage points and components allows to be installed in different ways, and even before the perimeter is erected. This system has multiple solutions for the closing of the corners, at the time that the access through itself can be made through certain points, by means of using stairs or elevator platforms.

Side protection system: general requirements

The height of the highest part of the edge protection has to be at least 1 m. Maximum openings: The side protection must be designed in such a way that it retains a sphere of a certain diameter.

El rodapié ha de tener una altura mínima de 150mm. (máx. hueco 20mm).

IMPORTANT: Los componentes han de tener una superficie y estar colocados de tal manera que se minimicen las lesiones corporales por pinchazos o laceraciones.

The toe board must have a minimum height of 150mm. (Maximum mesh size 20mm).

IMPORTANT: The components must have a surface and be placed in such a way that injuries in the worker are avoided.

El diámetro depende de la clase elegida:

Clase A \varnothing 470mm (Si se usan barandillas intermedias)
Class A \varnothing 250mm (Si se usa un panel con mallas)
 \varnothing 470mm (If intermediate rails are used)
 \varnothing 250mm (If a panel with meshes is used)

Clase B \varnothing 250mm
Class B \varnothing 250mm

Clase C \varnothing 100mm
Class C \varnothing 100mm

Norma Europea
European Standard
UNE-EN 13374

Clase A
Class A

De 0° a 10°
 de pendiente
 From 0° to 10°
 slope

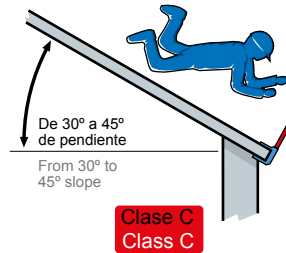
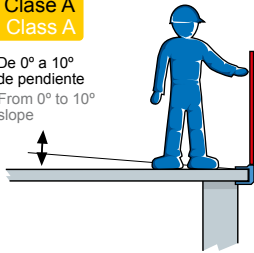

De 30° a 45°
 de pendiente
 From 30° to
 45° slope

Clase C
Class C

Altura de caída
 Height of fall

Inclinación superficie de trabajo
 Inclination surface of work

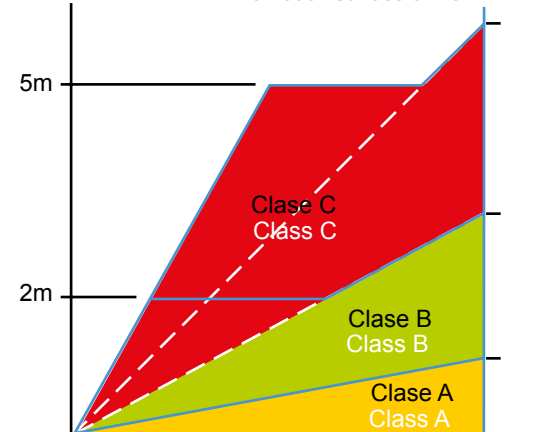

Clase B
Class B

De 10° a 30°
 de pendiente
 From 10° to
 30° slope

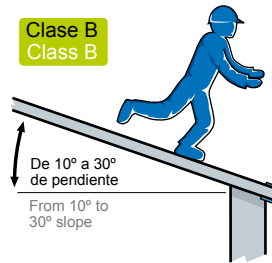

Sistema T T System

SISTEMA T
 System

Página 3 Tarifa. Page 3 Price List.

Red de seguridad sujeta a consolas para utilización horizontal.

Safety net tied to consoles for horizontal use.

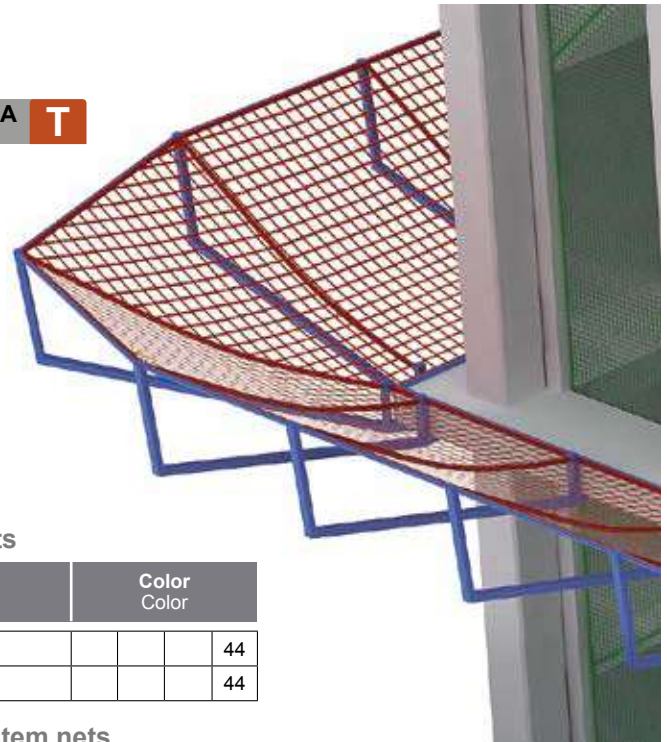

Redes sistema T poliamida Polyamide T system nets

Producto Product	Descripción Description	Color Color
1092081115	UD. RED C/NUDO PA 4,5MM TA2 Q100 3X4,5 M	44
1092081112	UD. RED C/NUDO PA 4,5MM TA2 Q100 3X6 M	44

Redes sistema T polipropileno Polypropylene T system nets

1091091115	UD. RED S/NUDO PPM 5MM TA2 Q100 3X4,5 M	11	22
1091091112	UD. RED S/NUDO PPM 5MM TA2 Q100 3X6 M	11	22

Sistemas U / cerramiento fachadas

U System / of front closure

Página 3 Tarifa. Page 3 Price List.

Red de seguridad, en posición sensiblemente vertical, diseñada para impedir la caída de personas al vacío.

Vertical safety net designed to prevent people from falling.

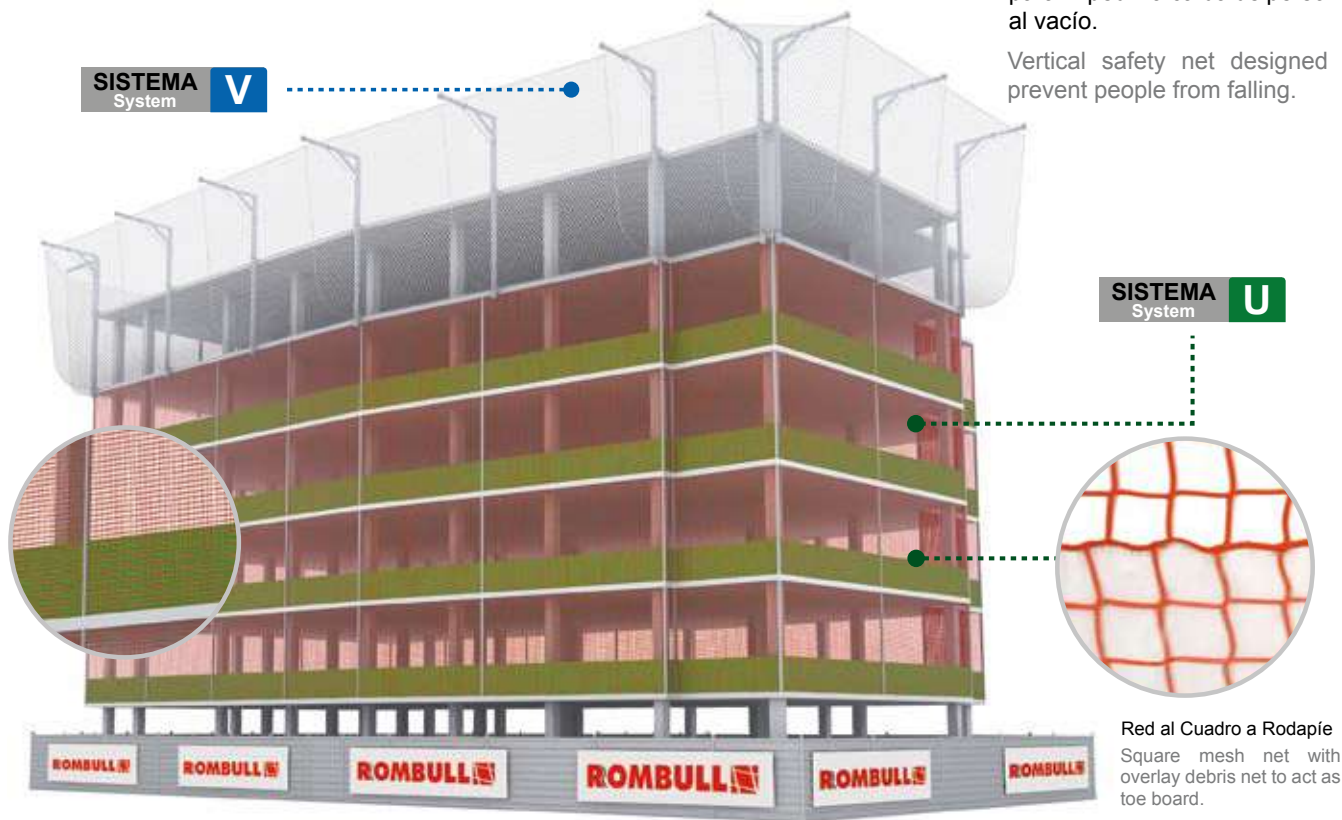

Red al Cuadro a Rodapíe
Square mesh net with overlay debris net to act as toe board.

▶ Redes cierre vertical Nets vertical closure

Producto Product	Descripción Description	Color Color			
1081091101	M2 RED S/NUDO PPM 5MM EN1263-1 UA2 Q100 M	11	22	33	44
5011092620	MTL. RED PLINTO MOSQUITERA RASCHEL G6050 0,50 M	11	22	33	44
5011092630	MTL. RED PLINTO MOSQUITERA RASCHEL G6050 1 M	11	22	33	44



▶ Cordelería Ropes

4100100009	UD. CUERDA UNION PA TRENZ 06MM EN1263-1 B/100 M				44
4796120010	UD. CUERDA PPM TRENZ C/ALMA 08MM EN1263-1 200 M				44



▶ Complementos Accessories

346012000300	ANCLAJE ASR 8MM
346014000300	ANCLAJE ASR 10MM



Anclaje ASR 8mm y 10mm
8mm and 10mm ASR Anchor

Acabado 11

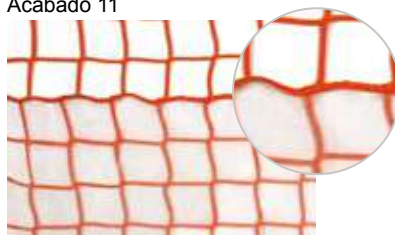

Red al Cuadro a Rodapíe
Skirting Square Net



Red 5mm Malla 100m
Net 5mm mesh 100m

Sistema U U System

Página 4 Tarifa. Page 4 Price List.

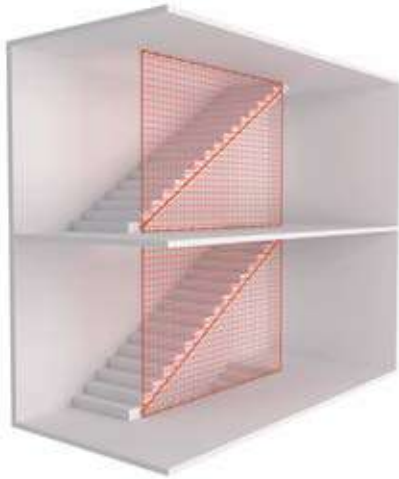

Redes de seguridad para colocar en los huecos de las escaleras, facilitan el trabajo y aportan una seguridad total.

Safety nets to be placed in the stairwells, to provide security during access and works.



Redes de seguridad para ventanas y huecos de ascensor.

Safety nets for windows and elevator shafts.



Red 5mm Malla 100m
Net 5mm mesh 100m



Anclaje ASR 8mm y 10mm
8mm and 10mm ASR Anchor

Redes cierre vertical Nets vertical closure

Producto Product	Descripción Description	Color Color			
1081091101	M2 RED S/NUDO PPM 5MM EN1263-1 UA2 Q100 M	11	22	33	44
5011092620	MTL. RED PLINTO MOSQUITERA RASCHEL G6050 0,50 M	11	22	33	44
5011092630	MTL. RED PLINTO MOSQUITERA RASCHEL G6050 1 M	11	22	33	44

Cordelería Ropes

4100100009	UD. CUERDA UNION PA TRENZ 06MM EN1263-1 B/100 M				44
4796120010	UD. CUERDA PPM TRENZ C/ALMA 08MM EN1263-1 200 M				44

Complementos Accessories

346012000300	ANCLAJE ASR 8MM
346014000300	ANCLAJE ASR 10MM



Red antidesprendimientos de fachadas

Nets to prevent debris falling from crumbling fronts – closure

Página 4 Tarifa. Page 4 Price List.



Redes de protección para cubrir fachadas en estado ruinoso o con riesgo de desprendimiento.

Safety nets to cover crumbling facades.

Producto Product	Descripción Description	Color Color		
1291091101	M2 RED CVF S/NUDO PPM 5MM Q100	11	22	33
1291071101	M2 RED CVF S/NUDO PPM 4MM Q100	11	22	33
1291050801	M2 RED CVF S/NUDO PPM 3MM Q50	11	22	33
1291091171	M2 RED CVF S/NUDO PPM 5MM QM100 C/MALLA RASCHEL COSIDA	11	22	33

Sistema de protección de fachada

Security system of fronts

Página 4 Tarifa. Page 4 Price List.

► Ud. Malla raschel protección fachada G6050

	Código	3x10	3x20	3x50	6x10	6x20	6x50
Verde	PRODUCTO	501190203111	501190204111	501190205111	501190206111	501190207111	501190208111
	EAN	8434035056756	8434035056800	8434035056855	8434035056916	8434035056961	8434035057029
Azul	PRODUCTO	501190203222	501190204222	501190205222	501190206222	501190207222	501190208222
	EAN	8434035056763	8434035056817	8434035056862	8434035056923	8434035056978	8434035057036
Rojo	PRODUCTO	501190203333	501190204333	501190205333	501190206333	501190207333	501190208333
	EAN	8434035056770	8434035056824	8434035056879	8434035056930	8434035056985	8434035057043
Blanco	PRODUCTO	501190203444	501190204444	501190205444	501190206444	501190207444	501190208444
	EAN	8434035056787	8434035056831	8434035056886	8434035056947	8434035056992	8434035057050
Amarillo	PRODUCTO	501190203555	501190204555	501190205555	501190206555	501190207555	501190208555
	EAN	8434035056794	8434035056848	8434035056893	8434035056954	8434035057005	8434035057067

► m² Malla raschel protección fachada G6050

Verde	501190201111	Azul	501190201222	Rojo	501190201333	Blanco	501190201444	Amarillo	501190201555
-------	--------------	------	--------------	------	--------------	--------	--------------	----------	--------------



Personalice su obra
o instalación
Customize your work
or installation

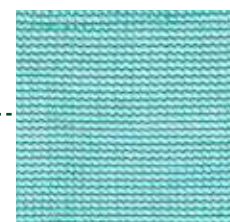

Malla Raschel
Raschel mesh

► Ud. Red mosquitera entramado 6x6

	Código	5x10
Verde	PRODUCTO	522190350111
	EAN	8434035066298
Azul	PRODUCTO	522190350222
	EAN	8434035066304
Blanco	PRODUCTO	522190350444
	EAN	8434035066311



► m² Red mosquitera entramado 6x6

Verde	522190301111	Azul	522190301222	Blanco	522190301444
-------	--------------	------	--------------	--------	--------------

Posicionamiento en el trabajo

Work positioning

Página 5 Tarifa. Page 5 Price List.

Las nuevas tecnologías de producción de redes sin nudo, permite la fabricación de redes extremadamente rígidas, estas se colocan en las obras tensándolas para formar una plataforma sobre la cual se pueda caminar.

The new technology of knotless nets production, allows the production of extremely rigid nets. These are installed and tensioned very tightly to provide a rigid platform where walking can be done over.

► **Posicionamiento en el trabajo Work positioning**

Producto Product	Descripción Description	Color Color
1151090701	M2 RED RP S/NUDO PPM 5MM Q45	11 22



Las redes de Posicionamiento en el Trabajo **proporcionan un entorno de trabajo seguro, que da confianza al montador de la estructura o cubierta** gracias a 2 ventajas básicas:

1. Los montadores pueden **acceder a la misma por cualquier lugar**.
2. Este tipo de red no sólo **protege al operario que monta la cubierta, sino que también protege de la caída de materiales a los operarios que se encuentran trabajando en niveles inferiores**. Esta característica cobra mayor importancia cuando existe un continuo tránsito de personas debajo del nivel en el que se están desarrollando los trabajos.

The Work Positioning nets provide a safe working area, **which gives confidence to the installer of the structure or cover** thanks to 2 basic advantages:

1. The installer can gain **access to the same structure from any place**.
2. This type of net does not only **protect the worker who installs the covering but, it also protects workers who are working at lower levels from falling objects**. These characteristics have major importance when a continued amount of persons in transit are under the working level.

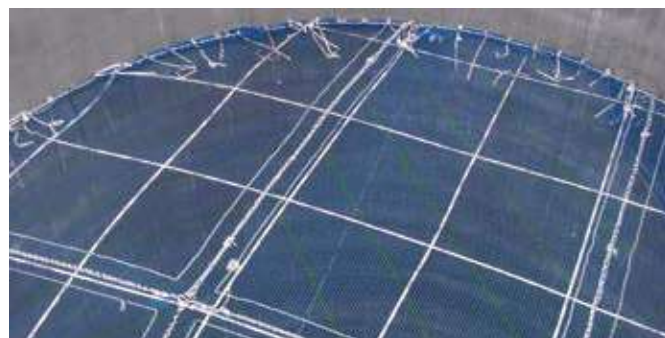

ROMBULL RONETS, S.L. recibió el Premio “a la investigación para la contribución en la seguridad en obra” por su RED DE POSICIONAMIENTO EN EL TRABAJO.

ROMBULL RONETS, S.L. received a research award for “its WORK POSITIONING NET as a contribution to safety at work”



Bajo forjado

Forged under

Página 5 Tarifa. Page 5 Price List.



Red de protección para la utilización en forjados en construcción.
Safety net for use in floors under construction.

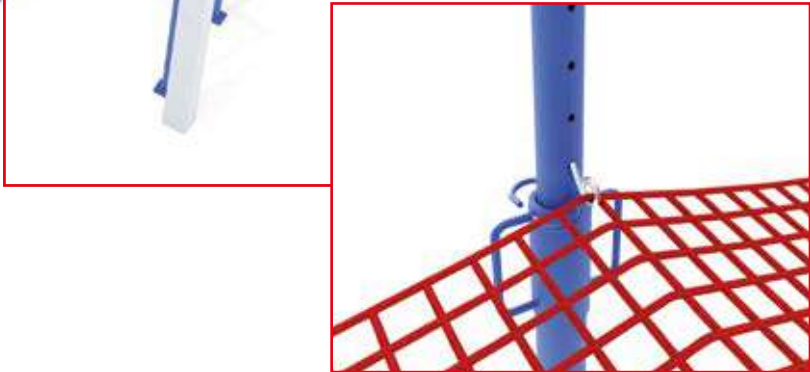

► Bajo forjado Forged under

Producto Product	Descripción Description	Color Color
134109110344	M2 RED BF S/NUDO PA 5MM UNE 81652 C Q100	44
134109110644	UD. RED BF S/NUDO PA 5MM UNE 81652 C Q100 1,10 X 10 M	44
134109112644	UD. RED BF S/NUDO PA 5MM UNE 81652 C Q100 2 X 10 M	44

Ganchos Hooks

347000000300



Ud. Gancho cincado BF RC 8mm
Ut. hook 8mm BF RC

350000000300



Ud. anclaje UNE 81652
Ut. anchorage UNE 81652

Redes de seguridad bajo forjado recuperables

Safety low underwork reusable nets

Rombull, ha desarrollado un nuevo producto que cubre las fuertes exigencias de la norma de redes bajo forjado **UNE 81652**. Las redes bajo forjado fabricadas en Rombull son producidas con la tecnología de Red Sin Nudo y Poliamida de Alta Tenacidad, obteniendo el mejor rendimiento de este tipo de tecnología, gracias a sus características de tenacidad y elongación, de la misma manera se ha creado un nuevo gancho, complemento del sistema de protección colectiva para redes bajo forjado Rombull.

Las redes de seguridad bajo forjado son la protección necesaria durante la fase de montaje de los sistemas de encofrado, el sistema de redes bajo forjado de Rombull permite el libre desplazamiento de los trabajadores a la hora de realizar estos trabajos de encofrado. Con la ventaja de la capacidad de retención amortiguadora, gracias a su capacidad elástica. Este sistema de seguridad está diseñado para su uso exclusivo en sistemas de encofrado soportados por puntales bajo la Norma **EN 1065**. Este sistema de seguridad no está diseñado para ser utilizado en sistemas de una altura inferior a 2,70 m.

Rombull Ronets has developed a new product which covers the strong demand that the rule **UNE 81652** establishes for forged under nets. The forged under nets are manufactured in Rombull Ronets with the latest technology, net without Knot and High Tenacity Polyamide obtaining the most efficient use thanks to these characteristics of tenacity and elongation. A new anchor has also been created to complement the collective protection system for forged under Rombull nets.

Forged under safety nets are the needed protection equipment during the process of mantelling formwork systems. Rombull Ronets forged under nets systems permits the free movement of workers while form working, with the advantage of its muffling retention capacity, due to its elasticity properties. These safety systems have been designed for their exclusive use in formwork systems supported under the rule **EN 1065**. This safety system has not been developed to be used in systems with a height under 2,70m.

Clase de Redes Class Networks	Tamaño máximo de malla en mm Maximum mesh size in mm	Energía mínima de rotura kJ Minimum breaking energy kJ
BF A	100	1,5
BF B	100	2,3

► Condiciones de uso Use conditions

Antes de subir al encofrado, verificar que está correctamente montado el sistema de seguridad.

Comprobar los siguientes puntos:

- Que no hay materiales sobre la red, esto impedirá su buen funcionamiento y podrá agravar los accidentes.
- No debe haber materiales apilados por encima de 1 metro del suelo debajo de la red.
- La distancia máxima de caída sobre la red no debe ser superior a 2,30 metros.
- La colocación del sistema de seguridad debe permitir como mínimo una distancia libre al suelo de un metro en el momento de instantánea máxima.

En caso de soportar el sistema una caída se debe sustituir la red que ha entrado en carga por una nueva.

First of all, check the safety system is correctly fixed.

Check the next points:

- There are no materials left on the net, this would avoid a good functioning and could also increase the risk of accidents.
- There should be no materials left over 1 meter from the floor, below the net.
- The maximum length of fall to the net should be no higher than 2,30 meters.
- The safety system installation must allow a free distance of 1 meter to the floor.

In case of holding a fall, the net must be replaced by a new one.

► Almacenaje Storage

Almacenar en un lugar seco, protegido de la luz solar, temperaturas extremas, productos químicos corrosivos.

Keep in a dry place, protected from direct sunlight, extreme temperatures or corrosive chemical products.

► Advertencias Warnings

Este sistema de redes de seguridad bajo la norma UNE 81652 sistema B, solo se debe montar siguiendo las instrucciones.

This safety net system, under the rule UNE 81652 System B, should only be installed following the instructions.

► Caducidad Expiration

La norma UNE 81652 establece una caducidad de las redes de bajo forjado con las especificaciones de esta norma de un año a partir de su fabricación.

The rule UNE 81652 sets an expiration date for low underwork nets following its specifications of 1 year from its manufacture.

Cordelería EN 1263-1

Standard EN 1263-1

Para el correcto funcionamiento del sistema de protección colectiva Rombull, es necesario el uso de cordelería certificada Rombull. Éstos son nuestros principales productos, pudiendo fabricar cuerdas de cualquier tipo color y grosor. Consúltenos. Norma Europea EN 1263-1.

For the correct operation of the Rombull collective protection system, it is necessary to use certified Rombull rope. These are our main products, being able to produce any colour and thickness strings. Contact us. European Standard EN 1263-1.

► Tipos de cuerdas y mallas Rope and mesh types

Cuerda Ropes				Resistencia mínima a la atracción kN Minimum traction resistance kN					Sistema System	Notas Notes
Denominación Denomination	Sin extremos Without	Con gaza With bright	Sin gaza Without	7,5	10	15	20	30		
F		X					X ^a		V	Cuerda de atado Tie rope
G			X		X ^b		X ^a		V	Cuerda de atado Tie rope
H		X			X ^b				V	Cuerda de atado Tie rope
J			X						V	Cuerda de atado Tie rope
K	X							X	S	Cuerda perimetral Border rope
L		X						X	S	Cuerda de atado Tie rope
M			X					X	S	Cuerda de atado Tie rope
N		X		X					S, T, U, V	Cuerda de unión Coupling rope
O			X	X					S, T, U, V	Cuerda de unión Coupling rope
P	X						X		V	Cuerda perimetral Border rope
R		X				X ^b			S	Cuerda de atado Tie rope
Z			X			X ^b			S	Cuerda de atado Tie rope

x^a Si la red se sujeta con un a cuerda con un ramal de carga.
If the net is attached a single rope.

x^b Si la red se sujeta con un a cuerda con doble ramal de carga.
If the net is attached a double rope.

► Comparativa de características de las fibras Comparative characteristics of the fibers

NOTA: se utiliza nylon como base de 1.0 NOTE: nylon is used as the basis of 1.0

Tipo de Fibra Genérica Generic Fiber Type	Nylon	Poliéster Polyester	Polipropileno Polypropylene
Tenacidad (g/den) ¹ Tenacity (g/den) ¹	7.5 - 10.5	7 - 10	6.5
Elongación ² Elongation ²	15 - 28%	12 - 18%	18 - 22%
Coefficiente de Fricción ³ Coefficient of Friction ³	.12 - .15	.12 - .15	-.15 - .22
Punto de Fusión Melting point	425° - 490° F	480° - 500° F	330° F
Temperatura Crítica ⁴ Critical Temperature ⁴	325° F	350° F	250° F
Gravedad Específica Specific Gravity	1.14	1.38	.91

1 **Tenacidad:** es la medida de resistencia a la rotura de las fibras.

2 **Elongación:** se refiere al porcentaje de elongación de las fibras hasta la rotura.

3 **Coefficiente de Fricción:** basado en la tendencia a la rozadura.

4 **Temperatura Crítica:** se refiere al punto en el que la degradación está causada únicamente por la temperatura.

1 **Tenacity:** is the measurement of the resistance of the fibers to breaking.

2 **Elongation:** refers to the percentage of elongation of the fibers at break.

3 **Coefficient of friction:** is based on reluctance to slip or slide.

4 **Critical temperature:** it refers to the point at which degradation is caused by temperature it self.

Cuerda de unión

Coupling rope

Norma Europea EN 1263-1
European Standard EN 1263-1

Página 6 Tarifa. Page 6 Price List.



Bobina

▶ Cuerda poliamida alta tenacidad

Polyamide braided rope



Blanco	Producto	EAN	Descripción	Resistencia
	410010000944	8434035028494	UD. CUERDA UNION PA TRENZ. 6MM EN1263-1 B/100MTL	7,5 kN



Balona

▶ Cuerda poliamida trenzada con alma

Polyamide double braided rope



Blanco	Producto	EAN	Descripción	Resistencia
	479710001044	8434035052239	UD. CUERDA PA TRENZ C/ALMA 6MM EN1263-1/200MTL	7,5 kN

Cuerda atado sistema V uso doble

Tie rope V system dual use

Norma Europea EN 1263-1
European Standard EN 1263-1

Página 6 Tarifa. Page 6 Price List.



Balona

▶ Cuerda trenzada polipropileno con alma

Polypropylene double braided rope



Blanco	Producto	EAN	Descripción	Resistencia
	479612001044	8434035052208	UD. CUERDA PPM TRENZ C/ALMA 8MM EN1263-1/200MTL	10 kN



Rollo

▶ Cuerda cableada polipropileno

Polypropylene twisted rope



Blanco	Producto	EAN	Descripción	Resistencia
	479314000944	8434035052185	UD. CUERDA PPM CABLEADA 10MM EN1263-1/100MTL	10 kN

Cuerda atado sistema S uso doble

Tie rope S system dual use

Norma Europea EN 1263-1
European Standard EN 1263-1

Página 6-7 Tarifa. Page 6-7 Price List.



Rollo

▶ Cuerda trenzada polipropileno Polypropylene braided rope



Blanco	Producto	EAN	Descripción	Resistencia
	479014000944	8434035052154	UD. CUERDA PPM TRENZ 10MM EN1263-1/100MTL	15 kN



Balona

▶ Cuerda trenzada poliéster Polyester braided rope



Blanco	Producto	EAN	Descripción	Resistencia
	479212001444	8434035052178	UD. CUERDA PES TRENZ 8MM EN1263-1/500MTL BLANCO	15 kN



Balona

▶ Cuerda poliamida trenzada con alma Polyamide double braided rope



Blanco	Producto	EAN	Descripción	Resistencia
	479712001044	8434035052246	UD. CUERDA PA TRENZ C/ALMA 8MM EN1263-1/200MTL	15 kN



Rollo

▶ Cuerda cableada polipropileno Polypropylene twisted rope



Blanco	Producto	EAN	Descripción	Resistencia
	479316000944	8434035052192	UD. CUERDA PPM CABLE 12MM EN1263-1/100MTL	15 kN



Cuerda atado sistema V

Tie rope V system

Norma Europea EN 1263-1
European Standard EN 1263-1

Página 7 Tarifa. Page 7 Price List.



Rollo

▶ Cuerda trenzada poliamida

Polyamide braided rope



Blanco	Producto	EAN	Descripción	Resistencia
	410014000944	8434035028524	UD. CUERDAATADO PA TRENZ 10MM EN1263-1/100MTL	20 kN



Rollo

▶ Cuerda cableada poliéster

Polyester twisted rope



Blanco	Producto	EAN	Descripción	Resistencia
	411014000944	8434035028616	UD. CUERDAATADO PES CABLE 10MM EN1263-1/100MTL	20 kN



Rollo

▶ Cuerda cableada poliamida

Polyamide twisted rope



Blanco	Producto	EAN	Descripción	Resistencia
	430014000944	8434035040397	UD. CUERDAATADO PA CABLE 10MM EN1263-1/100MTL	20 kN



Balona

▶ Cuerda trenzada polipropileno con alma

Polypropylene double braided rope



Blanco	Producto	EAN	Descripción	Resistencia
	479616000944	8434035052215	UD. CUERDA PPM TRENZ C/ALMA 12MM EN1263-1/100MTL	20 kN



Balona

▶ Cuerda trenzada poliamida con alma

Polyamide double braided rope



Blanco	Producto	EAN	Descripción	Resistencia
	479714000944	8434035052253	UD. CUERDA PA TRENZ C/ALMA 10MM EN1263-1/100MTL	20 kN



Rollo

▶ Cuerda fibra

Fiber rope



Blanco	Producto	EAN	Descripción	Resistencia
	455014000944	8434035047969	UD. CUERDA DE FIBRA ISO 1140 A 10 PA 2/100MTL	20 kN

Cuerda atado sistema S

Tie rope S system



Rollo

▶ Cuerda trenzada poliamida

Polyamide braided rope



Blanco	Producto	EAN	Descripción	Resistencia
	410017000944	8434035028579	UD. CUERDAATADO PA TRENZ 14MM EN 1263-1/100MTL	30 kN



Rollo

▶ Cuerda cableada poliéster

Polyester twisted rope



Blanco	Producto	EAN	Descripción	Resistencia
	411017000944	8434035028685	UD. CUERDAATADO PES CABLE 14MM EN1263-1/100MTL	30 kN



Rollo

▶ Cuerda cableada poliamida

Polyamide twisted rope



Blanco	Producto	EAN	Descripción	Resistencia
	430017000944	8434035040441	UD. CUERDAATADO PA CABL. 14MM EN 1263-1/100MTL	30 kN



Rollo

▶ Cuerda fibra

Fiber rope



Blanco	Producto	EAN	Descripción	Resistencia
	455016000944	8434035047990	UD. CUERDA DE FIBRA ISO 1140 A 12 PA 2/100MTL	30 kN



Static 10,5

Página 8 Tarifa. Page 8 Price List.

Cuerda semiestática para uso profesional poco intensivo, excelente relación calidad precio. No es necesario mojarla antes de usar, encogida en fábrica. De la bobina directa a la vertical.

Semi-static rope for professional low intensive use, excellent relation quality-price. No need to wet it before use, shrinked at factory. From spool direct to vertical.



Balona

► Cuerda profesional (EN-1891) semiestática tipo A Professional rope (EN-1891) semi-static type A

Producto Product	Descripción Description
476028001044	UD.CUERDA STATIC EN1891 10,5MM CONTRA /200M



► **Conservación Conservation**

Con la finalidad de prolongar la vida útil de las redes de seguridad y sus accesorios y conservar las propiedades de las mismas, siga las siguientes recomendaciones para su conservación:

- Las redes se deben almacenar y conservar en lugares secos.
- Las redes no deben de almacenarse en lugares cerca de fuentes de calor ni donde se realicen trabajos de soldaduras.
- Se debe vigilar que no estén en contacto con sustancias agresivas o que pudieran perjudicar a la red.
- Deben estar protegidas de la acción directa y continuada del sol.
- Se recomienda no sacar la red de la bolsa en que es suministrada hasta el momento de su utilización.

In order to extend the life of the safety net and its accessories, and to preserve its properties, follow these recommendations:

- The nets must be stored in a dry place.
- The nets should neither be stored near heated places nor where welding jobs are being done.
- Someone must supervise that the nets are not in contact with aggressive substances or substances that could damage it.
- The nets must be protected from direct and continuous sunlight.
- It is recommended not removing the net from its bag until the moment of use.

► **Mantenimiento Maintenance**

Para el correcto mantenimiento de la red será necesario realizar inspecciones visuales sobre la red, tanto en mallas como en las cuerdas que forman el elemento de protección. En caso de encontrar anomalías o desperfectos susceptibles de reparación le recomendamos que se ponga en contacto con el fabricante para su asesoramiento, esto garantizará un correcto mantenimiento de la red.

Dentro de este apartado, y como uno de los más importantes de este manual se encuentran las revisiones y controles de calidad. Toda red de seguridad debe llevar su etiqueta y sus cuerdas testigo, las cuales facilitarán al fabricante las condiciones necesarias para realizar análisis sobre las mismas y comprobar que la red continúa disfrutando de las propiedades necesarias para poder ser utilizada nuevamente.

For the correct maintenance of the net it will be necessary to make visual inspections on the net, including meshes and the ropes that form the element of protection. In case of finding any Abnormalities or manufacture defects, we recommend you contacting the manufacturer to advise you; this will guarantee a correct maintenance of the net.

In this section, and as one of the most important things in this manual, you can find the revisions and quality controls. Every safety net has to have its label and test ropes, which will facilitate to the manufacturer the right conditions to perform an analysis on the net and prove that the net still has the necessary properties that enables it to be used again.

► **Inspección de redes de seguridad Safety net inspection**

Durante el tiempo de uso de la red se deberán realizar una serie de inspecciones periódicas con el objeto de detectar desperfectos que puedan afectar el correcto funcionamiento de la red, tales como:

- Roturas o desfibrados de mallas de la red.
- Roturas o desfibrados de la cuerda perimetral.
- Las uniones de la cuerda perimetral a los puntos de anclaje.
- Las uniones entre las redes.
- El estado de otros elementos utilizados conjuntamente con la red como los cables, tensores y mosquetones.

Además de estos puntos se tendrán en cuenta los siguientes aspectos:

- La red deberá estar limpia de objetos cortantes, punzantes y abrasivos (grasa, madera, hormigón, plásticos, clavos u otros objetos que la puedan dañar).
- Cuando se produzca una rotura en las mallas que componen la red, ésta se deberá desmontar y sustituir, o en su defecto se colocará otro paño nuevo cosido sobre la zona deteriorada.
- La inspección y sustitución de las redes en obra deberá ser realizada por personal adecuadamente instruido.
- Una red de seguridad que haya evitado la caída de una persona u objeto solo podrá ser utilizada de nuevo tras haber sido revisada e inspeccionada por personal competente.

Si tiene dudas sobre la inspección de las redes, póngase en contacto con su proveedor o fabricante para su asesoramiento profesional.

During the time of use of the net, a series of periodical inspections must be completed with the purpose of detecting any manufacture defects that could affect the correct use of the net, including:

- Mesh of net damaged or unraveled.
- Border rope damaged or unraveled.
- The joining of the border rope to the anchorage points.
- The nets joining.
- The state of other elements also used with the net like cables, tensors, and carabineers.

Apport from these inspections, the following aspects will also be taken in to account:

- The net must be free of sharp and abrasive objects (grease, wood, concret, plastic, nails, or other objects that could damage the net).
- When a breakage occurs in the mesh that composes the net, this must be dismantled and replaced or in its defect new netting cloth will be placed and sewn over the damaged area.
- The inspection and replacement of nets on construction site must be done by professional and highly professional.
- A safety net that has prevented the fall of a person or object will be able to be used again after being checked by competent personnel.

If you have any questions about the inspection of the nets, contact your supplier or manufacturer for professional advice.

► Sustitución Replacement

La sustitución de la red se ha de llevar a cabo en el momento en que se produzca el deterioro de la misma. Este deterioro puede ser debido a diferentes factores que le afecten durante el uso de la red comentados en el punto anterior o por el paso del tiempo, como la degradación que se produce por efecto de la radiación solar.

Con el fin de determinar el grado de envejecimiento sufrido por la red, se realizan los ensayos sobre cuerdas o mallas de ensayo. Pasado un año desde la fecha de fabricación, indicada en la etiqueta de la red, se procederá al envío de la cuerda de ensayo señalada como "Cuerda de ensayo nº1" al fabricante de la red para que este proceda a realizar pruebas sobre la misma, si la fuerza de rotura de la cuerda de malla es igual o superior a la señalada a la etiqueta, la red podrá ser utilizada durante un año más. De igual manera se procederá al finalizar el segundo año de uso, con la "Cuerda de ensayo nº2".

Por lo que la sustitución de las redes de seguridad se realizará en los siguientes supuestos:

- Cuando tras haber soportado la caída de una persona u objeto pesado, la inspección de red por personal competente así lo aconseje.
- Cuando al realizar las pruebas sobre las cuerdas de ensayo, el resultado no sea el adecuado.

Los reglamentos particulares de AENOR y AIDICO, establece que las redes certificadas bajo su normativa tienen una caducidad de un año.

The replacement of the net has to be done at the moment when the deterioration of the same occurs. This damage can be caused by different factors that affect the net during its use mentioned on the previous point or by the ageing and the degradation caused by the net exposure to sunlight.

In order to determine the degree of deterioration suffered by the net, tests are made on the test ropes and test meshes. After a year from manufacturing date, indicated on the label on the net, will proceed to sending the test rope named as "Test rope nº 1" to the net manufacturer to perform tests on the rope/s. If the mesh rope's breaking strength is equal or greater than the one marked on the label, the net will be ready to be used during one more year. Following the same steps, will proceed again when the second year of use is completed, sending "Test rope nº 2" to perform testing.

This means that the replacement of the safety nets will be completed when:

- After having withstood the fall of a person or a heavy object and when the net inspection done by competent personnel advises to do so.
- After making the tests on the test ropes, the result is not the appropriate.

The characteristic regulation AENOR & AIDICO, establishes that a net certified under its normative has a year of expiration.



Etiqueta de identificación precintada
Identification label sealed

Hilos de prueba con precinto numerado
Test yarns are sealed and numbered

Etiqueta Label

Todas nuestras redes llevan bridas identificativas y una etiqueta donde aparecen, además de la normativa que cumple y características mecánicas de la misma, la fecha de fabricación y la fecha donde hay que hacer el próximo ensayo.

All of our nets have identifying seals and labels which appears, in addition to the regulations regarding mechanical characteristics of the net, the manufacturing date and the date indicating when next test is due.

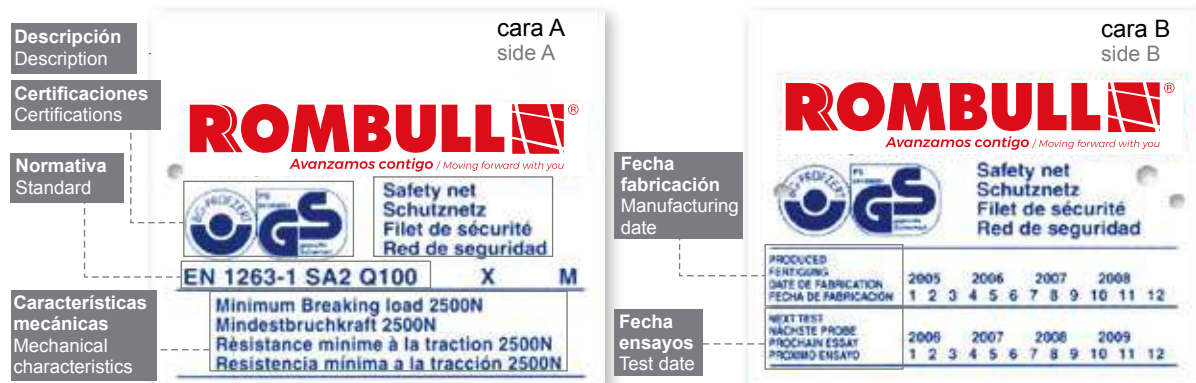

Una vez que la red alcanza la fecha indicada en su etiqueta como PRÓXIMO ENSAYO, se le extrae la CUERDA TESTIGO, sobre la que se realizan diferentes tests para comprobar la posible pérdida de energía que puede haber ocasionado el uso y la acción del medio ambiente sobre la red.

Si la cuerda testigo supera las pruebas satisfactoriamente, la red a la que pertenece podrá ser utilizada durante otro año, obteniendo de este modo la ETIQUETA DE RENOVACIÓN.

Once the net reaches the date indicated on the label as NEXT TEST, you must remove the WITNESS MESH, to which different test are performed to verify the possible loss of strength caused by uses and environment.

If the witness rope passes satisfactorily the test, the net to which it belongs will be able to be used for another year by obtaining the RENEWABLE LABEL.

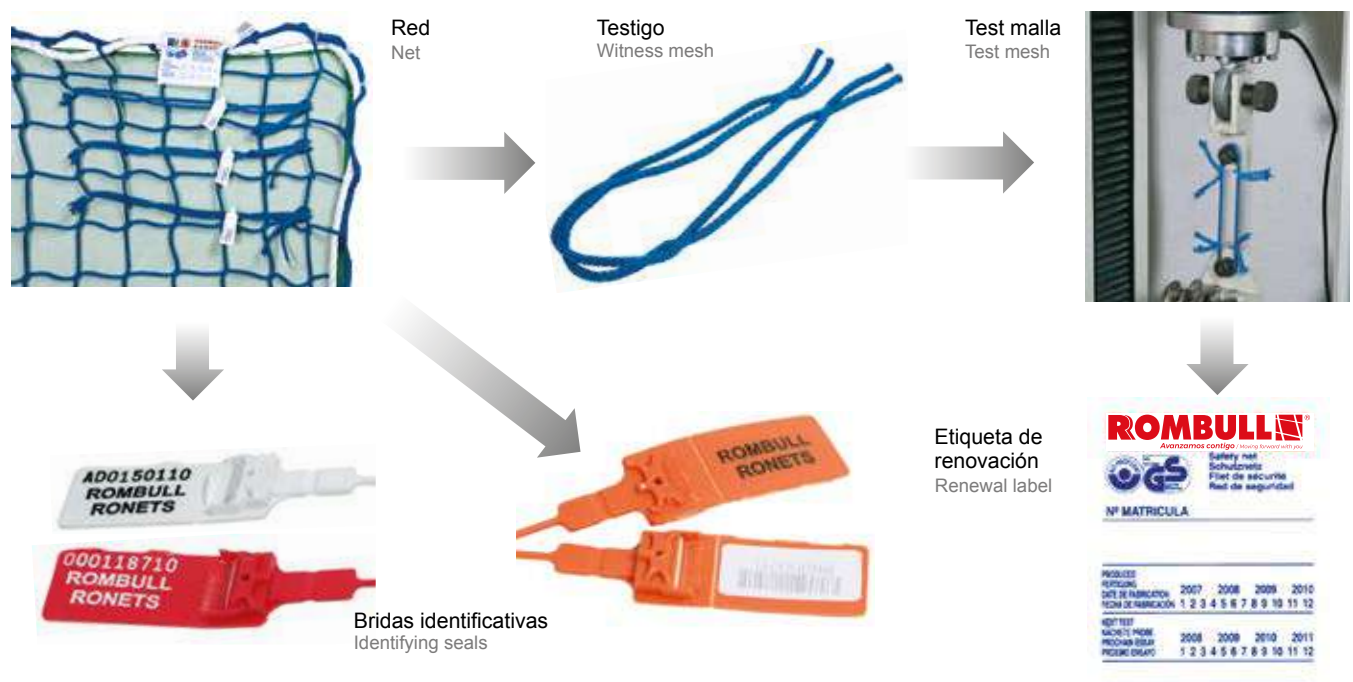

Opcional: bridas con código de barras Optional: seals with bar code

En nuestro compromiso por mejorar nuestro servicio y facilitarle su trabajo, hemos desarrollado un novedoso SISTEMA DE IDENTIFICACIÓN DIGITAL para las redes, gracias al cual usted podrá conocer en cada momento la localización y colocación exacta de cada una de sus redes.

In our commitment to improve our service and facilitate your work, we have developed a new SYSTEM OF DIGITAL IDENTIFICATION for the nets, thanks to which you will be able to know the location and exact installation of each of your nets in every moment.

Acabados y accesorios

Finishing and accessories

Acabado 1 Finishing 1



Red al rombo con orillado manual
Diamond mesh net with hand made
selvage

Acabado 2 Finishing 2



Red al cuadro
Square net

Acabado 3 Finishing 3



Red al cuadro con guardacabo en Gaza
Square net with thimble in loop

Acabado 4 Finishing 4



Red al cuadro con red anticascotes
Square net with unravelling net

Acabado 5 Finishing 5



Red al cuadro con mosquitera
Square net with scaffolding covers

Acabado 6 Finishing 6



Red al cuadro
Square net

Acabado 7 Finishing 7



Red al cuadro con mosquitera
Square net with scaffolding covers

Acabado 8 Finishing 8



Red al cuadro a soporte
Square net tied to a support

Acabado 9 Finishing 9



Red al cuadro cierre Toggle
Square net with Toggle system

Acabado 10 Finishing 10



Red al cuadro a soporte con GSV
Square net with GSV system

Acabado 11 Finishing 11

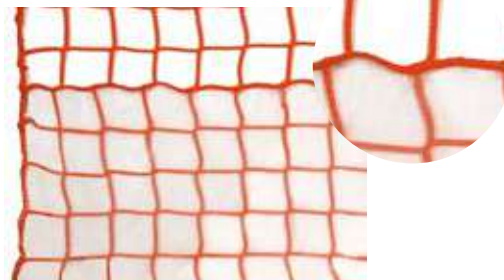

Red al cuadro a Rodapié
Skirting square net

Acabados y accesorios

Finishing and accessories

Rombull proporciona, además de redes de la más alta calidad, todos los accesorios y sujeciones necesarias para su correcta y segura fijación.

Rombull offers, besides high quality nets, all the accessories and fastening systems for the correct and secure fixation.

CABLE, CADENA Y ACCESORIOS
CHAINS, WIRE ROPES & ACCESORIES



Puedes ver la referencia de este artículo en la familia Cables, Cadenas y Accesorios (página 240 - 241 del catálogo)

You can see the reference of this article on Chains, Wire Ropes and Accessories (page 240 - 241 of catalog)

CABLE, CADENA Y ACCESORIOS
CHAINS, WIRE ROPES & ACCESORIES



Puedes ver la referencia de este artículo en la familia Cables, Cadenas y Accesorios (página 254 - 255 del catálogo)

You can see the reference of this article on Chains, Wire Ropes and Accessories (page 254 - 255 of catalog)

CABLE, CADENA Y ACCESORIOS
CHAINS, WIRE ROPES & ACCESORIES



Puedes ver la referencia de este artículo en la familia Cables, Cadenas y Accesorios (página 261 del catálogo)

You can see the reference of this article on Chains, Wire Ropes and Accessories (page 261 of catalog)

CABLE, CADENA Y ACCESORIOS
CHAINS, WIRE ROPES & ACCESORIES



Puedes ver la referencia de este artículo en la familia Cables, Cadenas y Accesorios (página 262 - 263 del catálogo)

You can see the reference of this article on Chains, Wire Ropes and Accessories (page 262 - 263 of catalog)

CABLE, CADENA Y ACCESORIOS
CHAINS, WIRE ROPES & ACCESORIES



Puedes ver la referencia de este artículo en la familia Cables, Cadenas y Accesorios (página 261 del catálogo)

You can see the reference of this article on Chains, Wire Ropes and Accessories (page 261 of catalog)



3240000003
Ud. Cierre GSV
Ut. GSV lock



347000000300
Ud. Gancho cincado BF RC 08mm
Ut. Hook 8mm BF RC



346014000300
Ud. Anclaje ASR-10 mm
Ut. Anchorage ASR-10 mm

346012000300
Ud. Anclaje ASR-08 mm
Ut. Anchorage ASR-08 mm



REDES DE DEPORTE

SPORT NETS

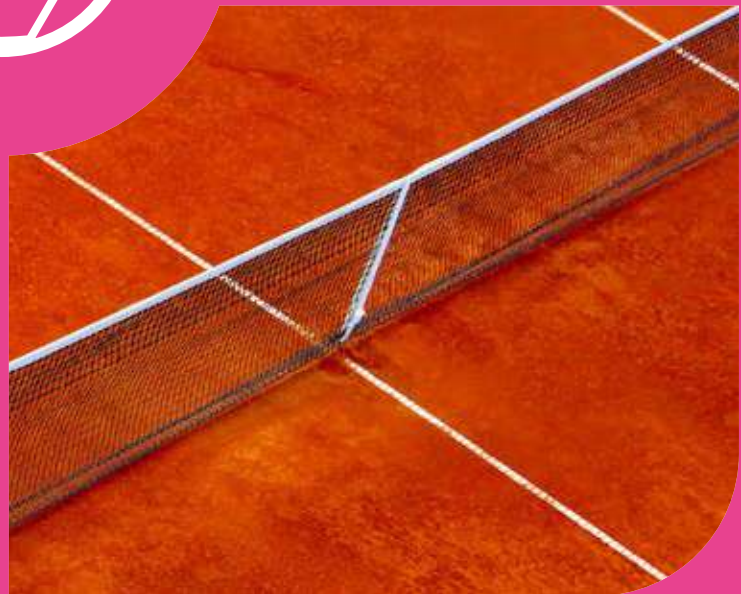

ROMBULL

Normativa Normative

Desde sus inicios ROMBULL está orientado para que la práctica del deporte, profesional y amateur se realice con la mejor equipación de redes, y así ayudar a nuestros deportistas a conseguir sus mejores resultados en sus competiciones. Por ello, nuestros productos están fabricados bajo las normativas más exigentes en cada deporte, que detallamos a continuación:

Rombull, since the beginning of its activities, has sought to develop the best net products for practicing sports at professional and amateur levels. The idea is to help our sport players to achieve the best results in their competitions. Therefore, our sport articles have been developed and produced under the most demanding standards of each sport, as we list in the following pages:

Norma Europea
EN-748

FÚTBOL
FOOTBALL



Porterías **FÚTBOL**
Football goals



Equipos de campos de juego, porterías de fútbol. Requisitos funcionales y de seguridad, métodos de ensayo.
Playing field equipment. Football goals. Functional and safety requirements, test methods.

Norma Europea
EN-749

BALONMANO
HANDBALL



Porterías **BALONMANO**
Handball goals



Equipos de campos de juego, porterías de balonmano. Requisitos de seguridad y funcionales, métodos de ensayo.
Playing field equipment. Handball goals. Functional and safety requirements, test methods.

Norma Europea
EN-750

HOCKEY
HOCKEY



Porterías **HOCKEY**
Hockey goals



Equipos de campos de juego, porterías de hockey. Requisitos y métodos de ensayo incluyendo la seguridad.
Playing field equipment. Hockey goals. Functional and safety requirements, test methods.

Norma Europea
EN-1271

VOLEIBOL
VOLLEYBALL



Red **VOLEIBOL**
Volleyball equipment

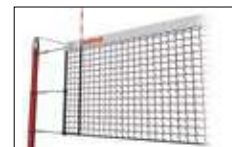

Equipamiento de los campos de juego equipos de voleibol. Requisitos funcionales y de seguridad, métodos de ensayo.
Playing field equipment. Volleyball equipment. Functional and safety requirements, test methods.

Norma Europea
EN-1510

TENIS
TENNIS



Red **TENIS**
Tennis equipment



Equipos de campos de juego equipos de tenis. Requisitos funcionales y de seguridad, métodos de ensayo.
Playing field equipment. Tennis equipment. Functional and safety requirements, test methods.



Nuestras **REDES SIN NUDOS DE POLIPROPILENO 100% EN BRUTO** han superado el STANDARD 100 by OEKO-TEX®

Our **KNOTLESS NETS MADE OF 100% POLYPROPYLENE** have passed the STANDARD 100 by OEKO-TEX®



Nomenclatura Nomenclature

► Características Characteristics

En las tablas de producto, en la columna "Descripción" se detallan las diferentes características de los productos:
In the product tables there is a "Description" column that presents all the features of our articles:

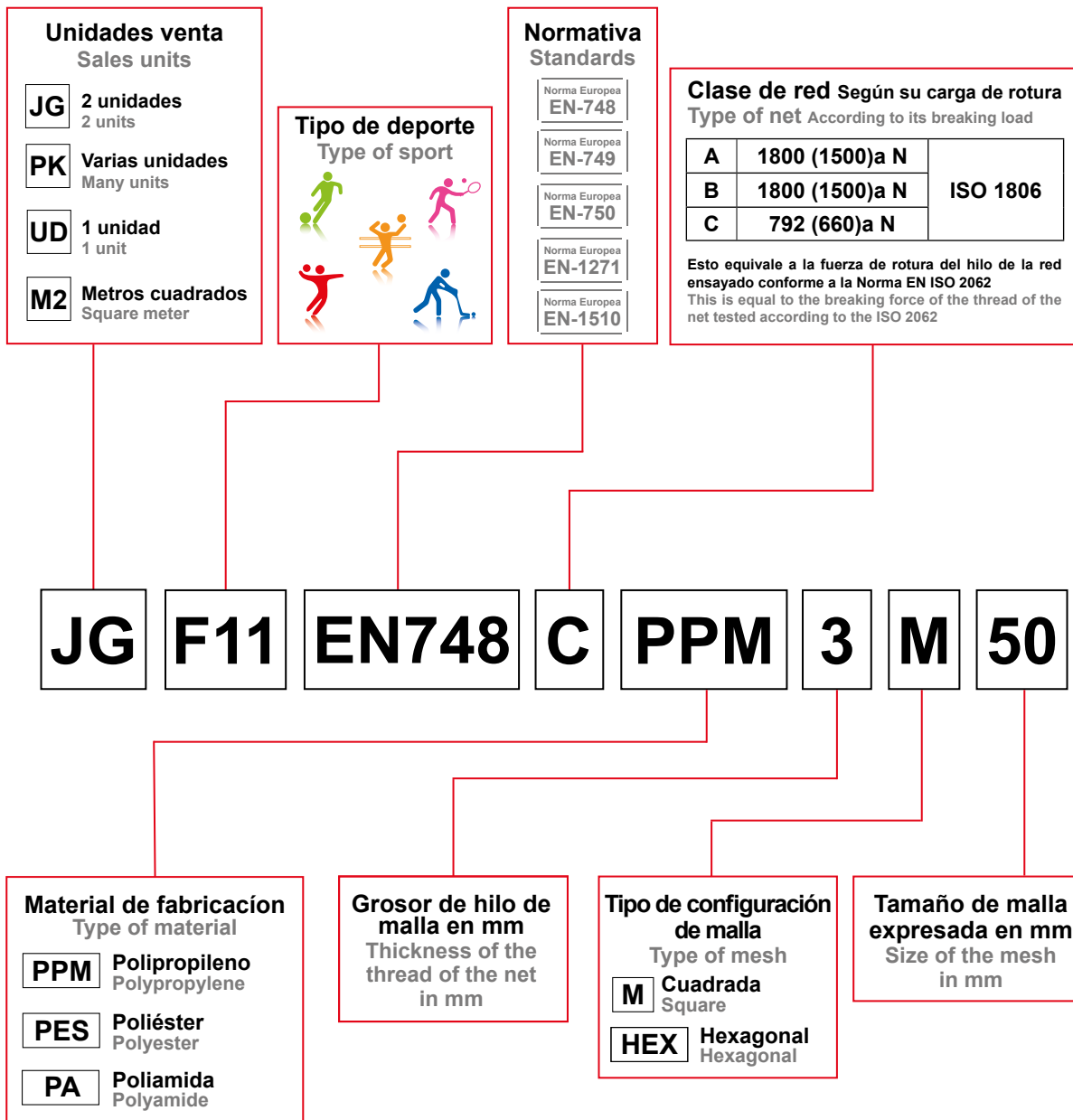

► Colores Colors

En las tablas de producto, en la columna "color" aparecen los tonos disponibles. En el momento de realizar su pedido, deberá indicar la referencia del producto y añadir el código del color seleccionado.

In the product tables there is a "color" column with all the available options. When placing an order, it is necessary to indicate the reference of the product and then add the color code selected.

Por ejemplo, si las redes las desea de color rojo, tendrá que especificarlo como se detalla a continuación:
For instance, if the nets ordered are red, it must be specified as follows:

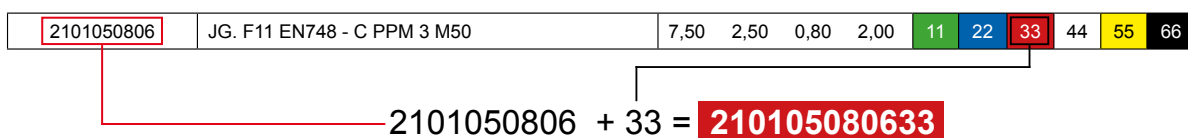

Fútbol 11

Football 11

Norma Europea
EN-748

FÚTBOL 11
Con cuerda de
tensión 6/8 mm Ø
With tension rope 6/8 mm Ø

Medidas Size 7,50 x 2,50 x 1,20 x 2,50m

Página 12 Tarifa. Page 12 Price List.

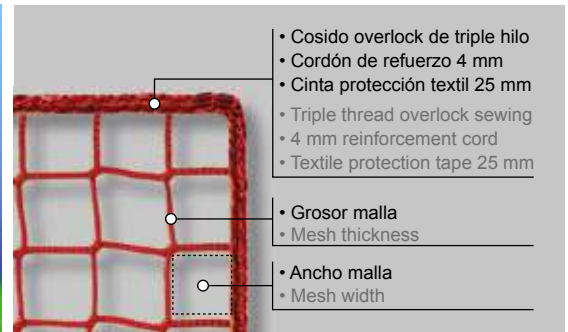
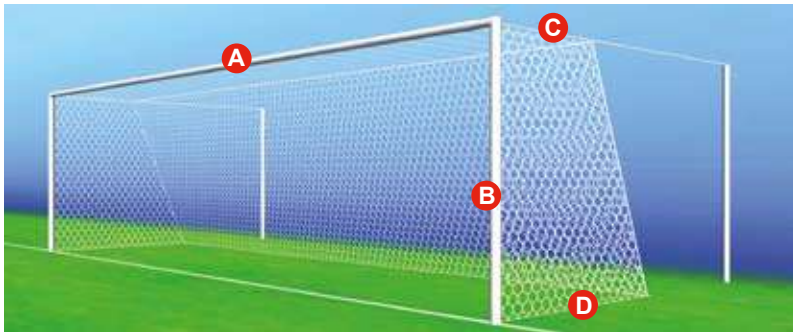

DESCRIPCIÓN: Juego de redes para porterías en polipropileno de alta tenacidad, poliamida y poliéster. Cumplen con las exigencias de la normativa aplicable en cada deporte. Instalación rápida y sencilla. Gran variedad en grosores, mallas y colores. Gran resistencia a la tracción y resistente a rayos UV.

DESCRIPTION: Pair of football goal nets made of high tenacity polypropylene, polyamide and polyester. They comply with the requirements of the regulations of each specific sport. They are easy and fast to install. We have a great assortment in many thicknesses, meshes and colors. These nets are UV protected and have excellent tensile strength.

Hexagonal SIN nudo
 Cuadrada SIN nudo
 Cuadrada CON nudo

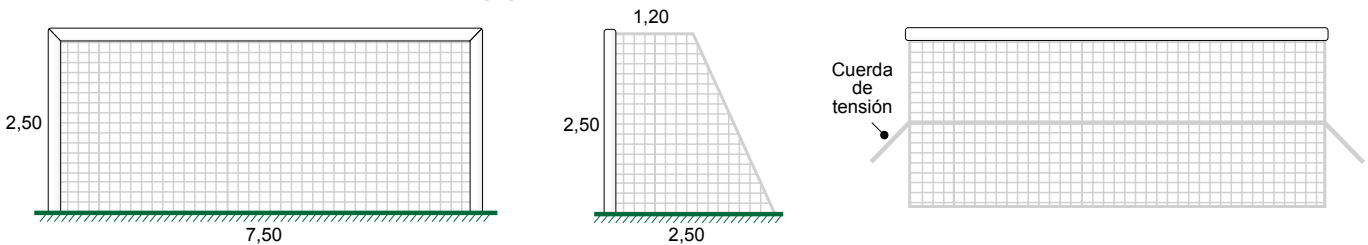

Producto Product	Descripción Description	Medidas Size				Color Color
		A	B	C	D	

▶ Redes sin nudo polipropileno Polypropylene knotless netting

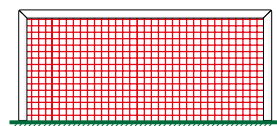

2101050804	JG. F11 EN748 - C PPM 3 M50	7,50	2,50	1,20	2,50	11	22	33	44	55	66
2101051104	JG. F11 EN748 - C PPM 3 M100	7,50	2,50	1,20	2,50	11	22	33	44	55	66
2101051204	JG. F11 EN748 - C PPM 3 M120	7,50	2,50	1,20	2,50	11	22	33	44	55	66

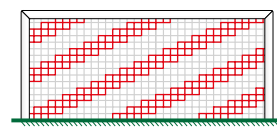

2101070804	JG. F11 EN748 - B PPM 4 M50	7,50	2,50	1,20	2,50	11	22	33	44	55	66
2101071104	JG. F11 EN748 - B PPM 4 M100	7,50	2,50	1,20	2,50	11	22	33	44	55	66
2101071204	JG. F11 EN748 - B PPM 4 M120	7,50	2,50	1,20	2,50	11	22	33	44	55	66

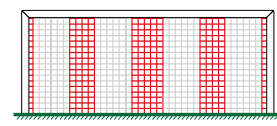

2101091104	JG. F11 EN748 - A PPM 5 M100	7,50	2,50	1,20	2,50	11	22	33	44	55	66
2101071204	JG. F11 EN748 - B PPM 4 M120 BICOLOR	7,50	2,50	1,20	2,50	1/4	2/4	3/4	5/6	4/6	
							2/3	3/6	2/5		

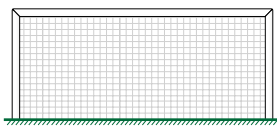

2101072904	JG. F11 EN748 - B PPM 4 HEX 50 BICOLOR	7,50	2,50	1,20	2,50	1/4	2/4	3/4	5/6	4/6	
2101072204	JG. F11 EN748 - B PPM 4 HEX 120 BICOLOR	7,50	2,50	1,20	2,50	1/4	2/4	3/4	44	5/6	4/6
							2/3	3/6	2/5		

▶ Redes con nudo poliamida Polyamide knotted netting

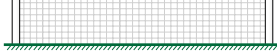

2102081204	JG. F11 EN748 - A PA 4,5 M120	7,50	2,50	1,20	2,50				44		
------------	-------------------------------	------	------	------	------	--	--	--	----	--	--



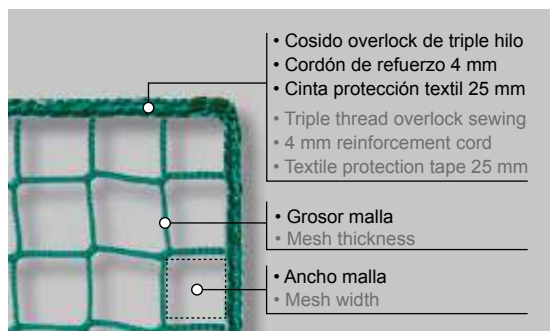
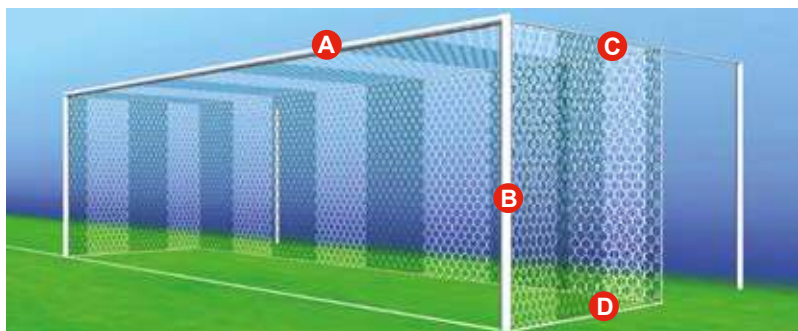

DESCRIPCIÓN: Juego de redes para porterías en polipropileno de alta tenacidad, poliamida y poliéster. Cumplen con las exigencias de la normativa aplicable en cada deporte. Instalación rápida y sencilla. Gran variedad en grosores, mallas y colores. Gran resistencia a la tracción y resistente a rayos UV.

DESCRIPTION: Pair of football goal nets made of high tenacity polypropylene, polyamide and polyester. They comply with the requirements of the regulations of each specific sport. They are easy and fast to install. We have a great assortment in many thicknesses, meshes and colors. These nets are UV protected and have excellent tensile strength.

Hexagonal SIN nudo
 Cuadrada SIN nudo
 Cuadrada CON nudo

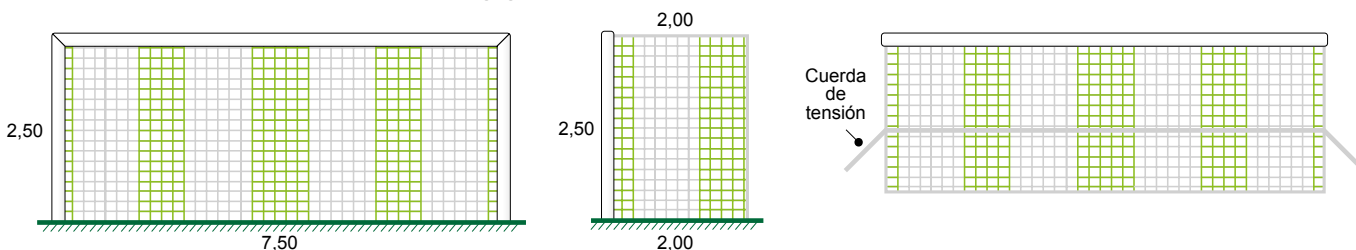

Producto Product	Descripción Description	Medidas Size				Color Color
		A	B	C	D	

▶ Redes sin nudo polipropileno Polypropylene knotless netting

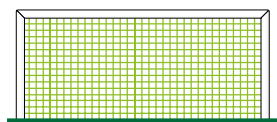

2101050809	JG. F11 EN748 - C PPM 3 M50	7,50	2,50	2,00	2,00	11	22	33	44	55	66
2101051109	JG. F11 EN748 - C PPM 3 M100	7,50	2,50	2,00	2,00	11	22	33	44	55	66
2101051209	JG. F11 EN748 - C PPM 3 M120	7,50	2,50	2,00	2,00	11	22	33	44	55	66

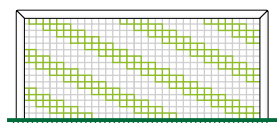

2101070809	JG. F11 EN748 - B PPM 4 M50	7,50	2,50	2,00	2,00	11	22	33	44	55	66
2101071109	JG. F11 EN748 - B PPM 4 M100	7,50	2,50	2,00	2,00	11	22	33	44	55	66
2101071209	JG. F11 EN748 - B PPM 4 M120	7,50	2,50	2,00	2,00	11	22	33	44	55	66

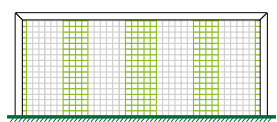

2101091109	JG. F11 EN748 - A PPM 5 M100	7,50	2,50	2,00	2,00	11	22	33	44	55	66
------------	------------------------------	------	------	------	------	----	----	----	----	----	----

2101071209	JG. F11 EN748 - B PPM 4 M120 BICOLOR	7,50	2,50	2,00	2,00	1/4	2/4	3/4	5/6	4/6	
							2/3	3/6	2/5		

2101072909	JG. F11 EN748 - B PPM 4 HEX 50 BICOLOR	7,50	2,50	2,00	2,00	1/4	2/4	3/4	5/6	4/6	
							2/3	3/6	2/5		

2101072209	JG. F11 EN748 - B PPM 4 HEX 120 BICOLOR	7,50	2,50	2,00	2,00	1/4	2/4	3/4	44	5/6	4/6
							2/3	3/6	2/5		

▶ Redes con nudo poliéster Polyester knotted netting

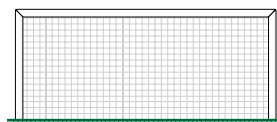

2105061109	JG. F11 EN748 - B PES 3,5 M100	7,50	2,50	2,00	2,00				44		
2105061209	JG. F11 EN748 - B PES 3,5 M120	7,50	2,50	2,00	2,00				44		

▶ Redes con nudo poliamida Polyamide knotted netting

2102061209	JG. F11 EN748 - B PA 3,5 M120	7,50	2,50	2,00	2,00				44		
2102081209	JG. F11 EN748 - B PA 4,5 M120	7,50	2,50	2,00	2,00				44		

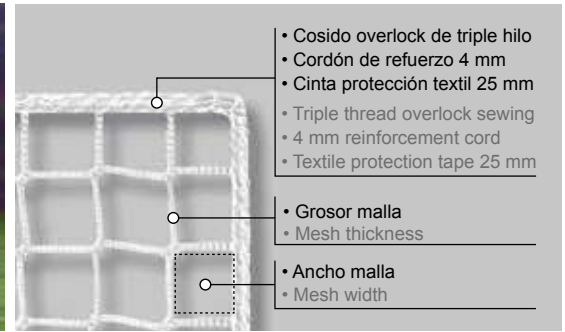
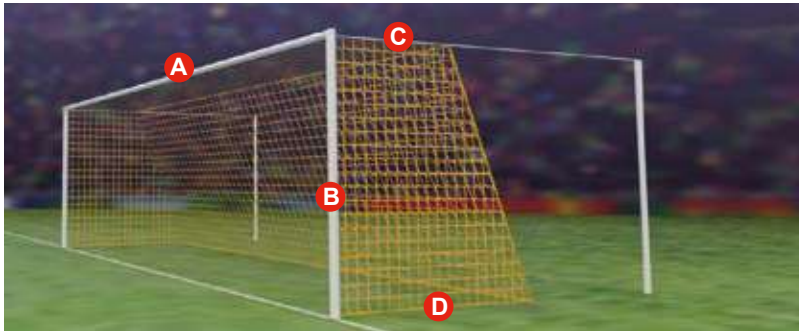

DESCRIPCIÓN: Juego de redes para porterías en polipropileno de alta tenacidad, poliamida y poliéster. Cumplen con las exigencias de la normativa aplicable en cada deporte. Instalación rápida y sencilla. Gran variedad en grosores, mallas y colores. Gran resistencia a la tracción y resistente a rayos UV.

DESCRIPTION: Pair of football goal nets made of high tenacity polypropylene, polyamide and polyester. They comply with the requirements of the regulations of each specific sport. They are easy and fast to install. We have a great assortment in many thicknesses, meshes and colors. These nets are UV protected and have excellent tensile strength.

Hexagonal SIN nudo
 Cuadrada SIN nudo
 Cuadrada CON nudo

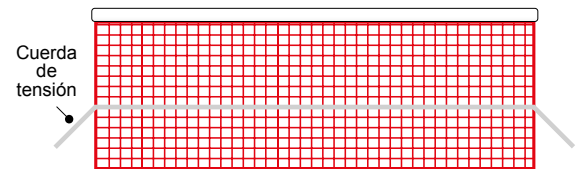
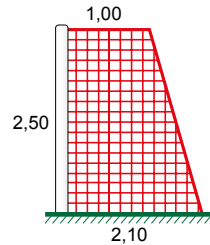
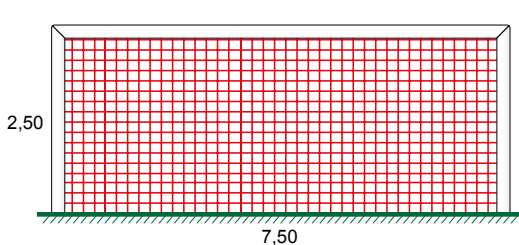

Producto Product	Descripción Description	Medidas Size				Color Color
		A	B	C	D	

▶ Redes sin nudo polipropileno Polypropylene knotless netting

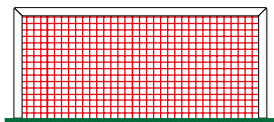

2101050805	JG. F11 EN748 - C PPM 3 M50	7,50	2,50	1,00	2,10	11	22	33	44	55	66
2101051105	JG. F11 EN748 - C PPM 3 M100	7,50	2,50	1,00	2,10	11	22	33	44	55	66
2101051205	JG. F11 EN748 - C PPM 3 M120	7,50	2,50	1,00	2,10	11	22	33	44	55	66

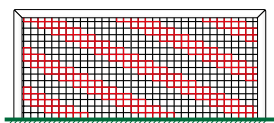

2101070805	JG. F11 EN748 - B PPM 4 M50	7,50	2,50	1,00	2,10	11	22	33	44	55	66
2101071105	JG. F11 EN748 - B PPM 4 M100	7,50	2,50	1,00	2,10	11	22	33	44	55	66
2101071205	JG. F11 EN748 - B PPM 4 M120	7,50	2,50	1,00	2,10	11	22	33	44	55	66

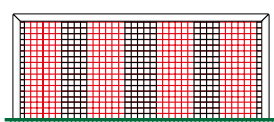

2101091105	JG. F11 EN748 - A PPM 5 M100	7,50	2,50	1,00	2,10	11	22	33	44	55	66
------------	------------------------------	------	------	------	------	----	----	----	----	----	----

2101071205	JG. F11 EN748 - B PPM 4 M120 BICOLOR	7,50	2,50	1,00	2,10	1/4	2/4	3/4	5/6	4/6	2/3	3/6	2/5
------------	--------------------------------------	------	------	------	------	-----	-----	-----	-----	-----	-----	-----	-----

2101072905	JG. F11 EN748 - B PPM 4 HEX 50 BICOLOR	7,50	2,50	1,00	2,10	1/4	2/4	3/4	5/6	4/6	2/3	3/6	2/5
------------	--	------	------	------	------	-----	-----	-----	-----	-----	-----	-----	-----

2101072205	JG. F11 EN748 - B PPM 4 HEX 120 BICOLOR	7,50	2,50	1,00	2,10	1/4	2/4	3/4	44	5/6	4/6	2/3	3/6	2/5
------------	---	------	------	------	------	-----	-----	-----	----	-----	-----	-----	-----	-----

▶ Redes con nudo poliéster Polyester knotted netting

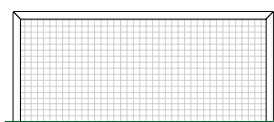

2105061105	JG. F11 EN748 - B PES 3,5 M100	7,50	2,50	1,00	2,10						44	
2105061205	JG. F11 EN748 - B PES 3,5 M120	7,50	2,50	1,00	2,10						44	

▶ Redes con nudo poliamida Polyamide knotted netting

2102061205	JG. F11 EN748 - B PA 3,5 M120	7,50	2,50	1,00	2,10						44	
2102081205	JG. F11 EN748 - B PA 4,5 M120	7,50	2,50	1,00	2,10						44	

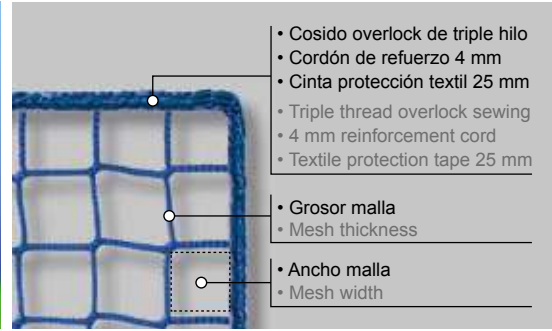
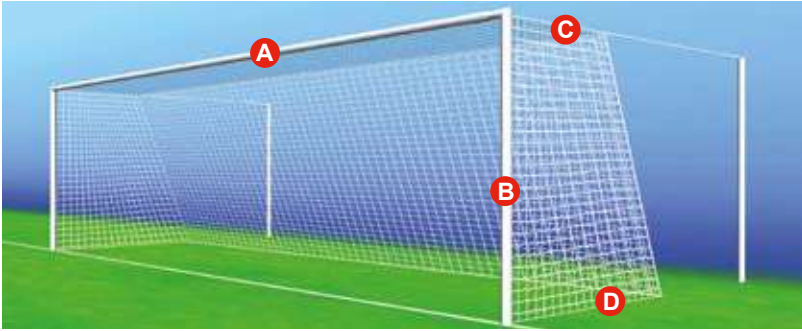

DESCRIPCIÓN: Juego de redes para porterías en polipropileno de alta tenacidad, poliamida y poliéster. Cumplen con las exigencias de la normativa aplicable en cada deporte. Instalación rápida y sencilla. Gran variedad en grosores, mallas y colores. Gran resistencia a la tracción y resistente a rayos UV.

DESCRIPTION: Pair of football goal nets made of high tenacity polypropylene, polyamide and polyester. They comply with the requirements of the regulations of each specific sport. They are easy and fast to install. We have a great assortment in many thicknesses, meshes and colors. These nets are UV protected and have excellent tensile strength.

Hexagonal SIN nudo
 Cuadrada SIN nudo
 Cuadrada CON nudo

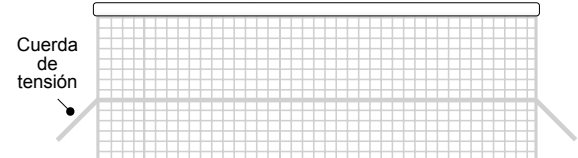
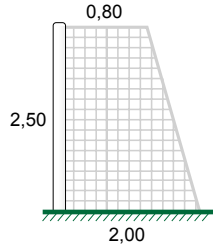
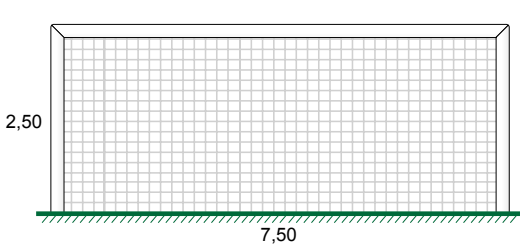

Producto Product	Descripción Description	Medidas Size				Color Color					
		A	B	C	D						

▶ Redes sin nudo polipropileno Polypropylene knotless netting

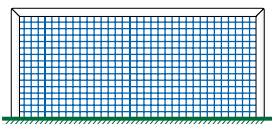

2101050806	JG. F11 EN748 - C PPM 3 M50	7,50	2,50	0,80	2,00	11	22	33	44	55	66
2101051106	JG. F11 EN748 - C PPM 3 M100	7,50	2,50	0,80	2,00	11	22	33	44	55	66
2101051206	JG. F11 EN748 - C PPM 3 M120	7,50	2,50	0,80	2,00	11	22	33	44	55	66

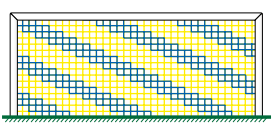

2101070806	JG. F11 EN748 - B PPM 4 M50	7,50	2,50	0,80	2,00	11	22	33	44	55	66
2101071106	JG. F11 EN748 - B PPM 4 M100	7,50	2,50	0,80	2,00	11	22	33	44	55	66
2101071206	JG. F11 EN748 - B PPM 4 M120	7,50	2,50	0,80	2,00	11	22	33	44	55	66

2101091106	JG. F11 EN748 - A PPM 5 M100	7,50	2,50	0,80	2,00	11	22	33	44	55	66
------------	------------------------------	------	------	------	------	----	----	----	----	----	----

2101071206	JG. F11 EN748 - B PPM 4 M120 BICOLOR	7,50	2,50	0,80	2,00	1/4	2/4	3/4	44	5/6	4/6
							2/3	3/6		2/5	

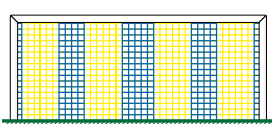

2101072906	JG. F11 EN748 - B PPM 4 HEX 50 BICOLOR	7,50	2,50	0,80	2,00	1/4	2/4	3/4	44	5/6	4/6
2101072206	JG. F11 EN748 - B PPM 4 HEX 120 BICOLOR	7,50	2,50	0,80	2,00	1/4	2/4	3/4	44	5/6	4/6
							2/3	3/6		2/5	

▶ Redes con nudo poliéster Polyester knotted netting

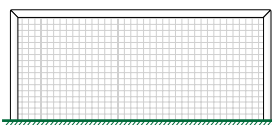

2105061106	JG. F11 EN748 - B PES 3,5 M100	7,50	2,50	0,80	2,00					44	
2105061206	JG. F11 EN748 - B PES 3,5 M120	7,50	2,50	0,80	2,00					44	

▶ Redes con nudo poliamida Polyamide knotted netting

2102061206	JG. F11 EN748 - B PA 3,5 M120	7,50	2,50	0,80	2,00					44	
2102081206	JG. F11 EN748 - B PA 4,5 M120	7,50	2,50	0,80	2,00					44	

Fútbol 11

Football 11

Norma Europea
EN-748

FÚTBOL 11
Con cuerda de
tensión 6/8 mm Ø
With tension rope 6/8 mm Ø

Medidas Size 7,50 x 2,50 x 0,80 x 1,50m

Página 14 Tarifa. Page 14 Price List.

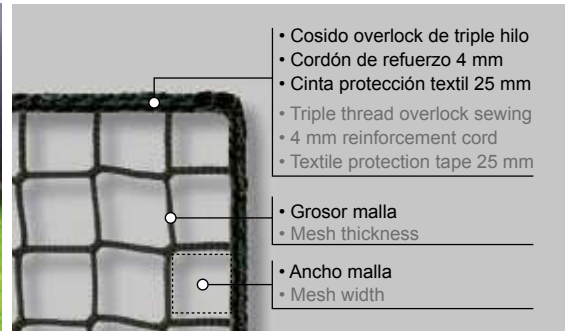
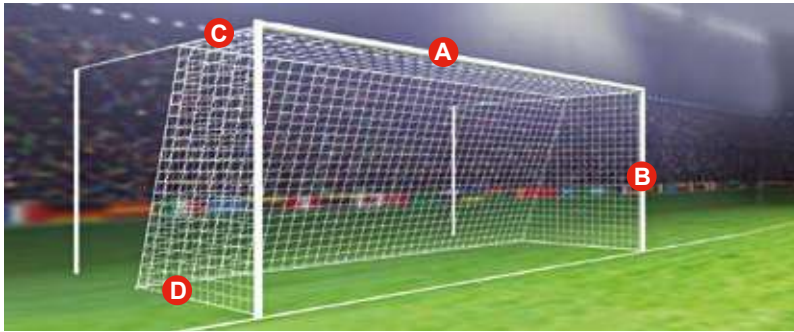

DESCRIPCIÓN: Juego de redes para porterías en polipropileno de alta tenacidad, poliamida y poliéster. Cumplen con las exigencias de la normativa aplicable en cada deporte. Instalación rápida y sencilla. Gran variedad en grosores, mallas y colores. Gran resistencia a la tracción y resistente a rayos UV.

DESCRIPTION: Pair of football goal nets made of high tenacity polypropylene, polyamide and polyester. They comply with the requirements of the regulations of each specific sport. They are easy and fast to install. We have a great assortment in many thicknesses, meshes and colors. These nets are UV protected and have excellent tensile strength.

Hexagonal SIN nudo
 Cuadrada SIN nudo
 Cuadrada CON nudo

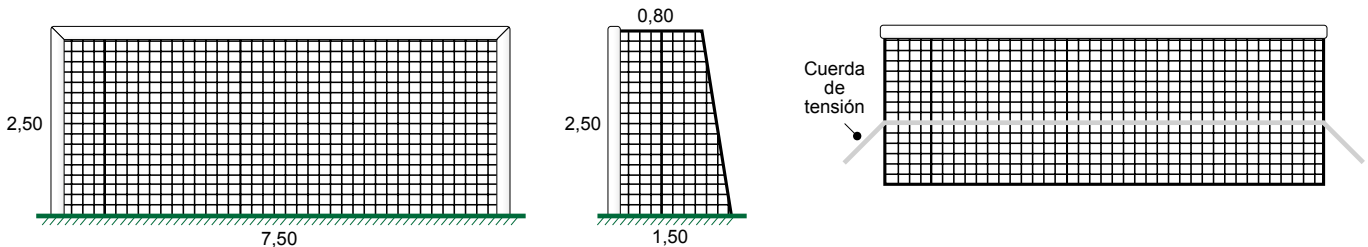

Producto Product	Descripción Description	Medidas Size				Color Color					
		A	B	C	D						

▶ Redes sin nudo polipropileno Polypropylene knotless netting

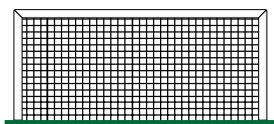

2101050807	JG. F11 EN748 - C PPM 3 M50	7,50	2,50	0,80	1,50	11	22	33	44	55	66
2101051107	JG. F11 EN748 - C PPM 3 M100	7,50	2,50	0,80	1,50	11	22	33	44	55	66
2101051207	JG. F11 EN748 - C PPM 3 M120	7,50	2,50	0,80	1,50	11	22	33	44	55	66

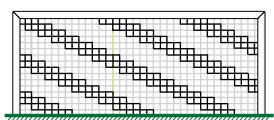

2101070807	JG. F11 EN748 - B PPM 4 M50	7,50	2,50	0,80	1,50	11	22	33	44	55	66
2101071107	JG. F11 EN748 - B PPM 4 M100	7,50	2,50	0,80	1,50	11	22	33	44	55	66
2101071207	JG. F11 EN748 - B PPM 4 M120	7,50	2,50	0,80	1,50	11	22	33	44	55	66

2101091107	JG. F11 EN748 - A PPM 5 M100	7,50	2,50	0,80	1,50	11	22	33	44	55	66
------------	------------------------------	------	------	------	------	----	----	----	----	----	----

2101071207	JG. F11 EN748 - B PPM 4 M120 BICOLOR	7,50	2,50	0,80	1,50	1/4	2/4	3/4	5/6	4/6	
							2/3	3/6	2/5		

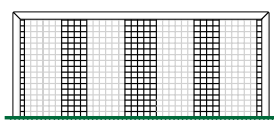

2101072907	JG. F11 EN748 - B PPM 4 HEX 50 BICOLOR	7,50	2,50	0,80	1,50	1/4	2/4	3/4	5/6	4/6	
							2/3	3/6	2/5		

2101072207	JG. F11 EN748 - B PPM 4 HEX 120 BICOLOR	7,50	2,50	0,80	1,50	1/4	2/4	3/4	44	5/6	4/6
							2/3	3/6	2/5		

▶ Redes con nudo poliéster Polyester knotted netting

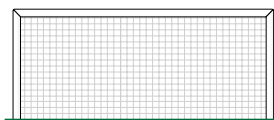

2105061107	JG. F11 EN748 - B PES 3,5 M100	7,50	2,50	0,80	1,50				44		
2105061207	JG. F11 EN748 - B PES 3,5 M120	7,50	2,50	0,80	1,50				44		

▶ Redes con nudo poliamida Polyamide knotted netting

2102061207	JG. F11 EN748 - B PA 3,5 M120	7,50	2,50	0,80	1,50				44		
2102081207	JG. F11 EN748 - B PA 4,5 M120	7,50	2,50	0,80	1,50				44		

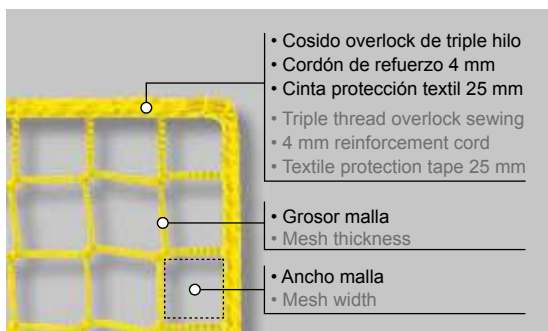

DESCRIPCIÓN: Juego de redes para porterías en polipropileno de alta tenacidad, poliamida y poliéster. Cumplen con las exigencias de la normativa aplicable en cada deporte. Instalación rápida y sencilla. Gran variedad en grosores, mallas y colores. Gran resistencia a la tracción y resistente a rayos UV.

DESCRIPTION: Pair of football goal nets made of high tenacity polypropylene, polyamide and polyester. They comply with the requirements of the regulations of each specific sport. They are easy and fast to install. We have a great assortment in many thicknesses, meshes and colors. These nets are UV protected and have excellent tensile strength.

Hexagonal SIN nudo
 Cuadrada SIN nudo
 Cuadrada CON nudo

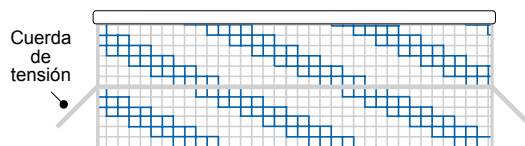
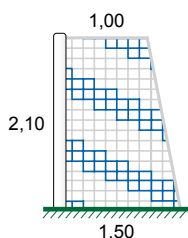
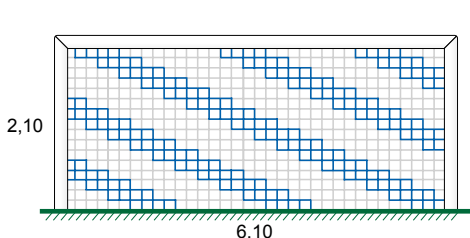

Producto Product	Descripción Description	Medidas Size				Color Color					
		A	B	C	D						

▶ Redes sin nudo polipropileno Polypropylene knotless netting

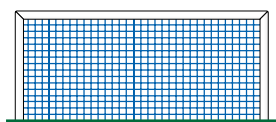

2111050810	JG. F7 EN748 - C PPM 3 M50	6,10	2,10	1,00	1,50	11	22	33	44	55	66
2111051110	JG. F7 EN748 - C PPM 3 M100	6,10	2,10	1,00	1,50	11	22	33	44	55	66
2111051210	JG. F7 EN748 - C PPM 3 M120	6,10	2,10	1,00	1,50	11	22	33	44	55	66

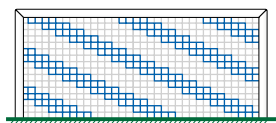

2111070810	JG. F7 EN748 - B PPM 4 M50	6,10	2,10	1,00	1,50	11	22	33	44	55	66
2111071110	JG. F7 EN748 - B PPM 4 M100	6,10	2,10	1,00	1,50	11	22	33	44	55	66
2111071210	JG. F7 EN748 - B PPM 4 M120	6,10	2,10	1,00	1,50	11	22	33	44	55	66

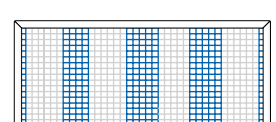

2111091110	JG. F7 EN748 - A PPM 5 M100	6,10	2,10	1,00	1,50	11	22	33	44	55	66
------------	-----------------------------	------	------	------	------	----	----	----	----	----	----

2111071210	JG. F7 EN748 - B PPM 4 M120 BICOLOR	6,10	2,10	1,00	1,50	1/4	2/4	3/4	5/6	4/6	
							2/3	3/6	2/5		

2111072910	JG. F7 EN748 - B PPM 4 HEX 50 BICOLOR	6,10	2,10	1,00	1,50	1/4	2/4	3/4	5/6	4/6	
							2/3	3/6	2/5		

2111072210	JG. F7 EN748 - B PPM 4 HEX 120 BICOLOR	6,10	2,10	1,00	1,50	1/4	2/4	3/4	44	5/6	4/6
							2/3	3/6	2/5		

▶ Redes con nudo poliéster Polyester knotted netting

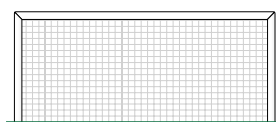

2115061110	JG. F7 EN748 - B PES 3,5 M100	6,10	2,10	1,00	1,50					44	
2115061210	JG. F7 EN748 - B PES 3,5 M120	6,10	2,10	1,00	1,50					44	

▶ Redes con nudo poliamida Polyamide knotted netting

2112061210	JG. F7 EN748 - B PA 3,5 M120	6,10	2,10	1,00	1,50					44	
2112081210	JG. F7 EN748 - B PA 4,5 M120	6,10	2,10	1,00	1,50					44	

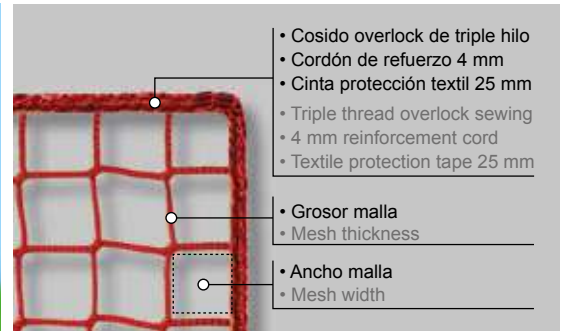
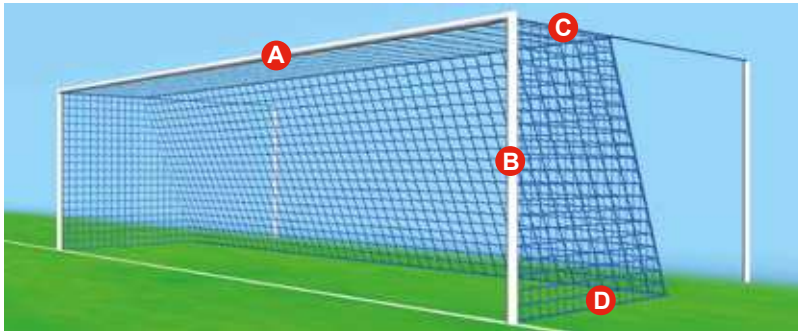

DESCRIPCIÓN: Juego de redes para porterías en polipropileno de alta tenacidad, poliamida y poliéster. Cumplen con las exigencias de la normativa aplicable en cada deporte. Instalación rápida y sencilla. Gran variedad en grosores, mallas y colores. Gran resistencia a la tracción y resistente a rayos UV.

DESCRIPTION: Pair of football goal nets made of high tenacity polypropylene, polyamide and polyester. They comply with the requirements of the regulations of each specific sport. They are easy and fast to install. We have a great assortment in many thicknesses, meshes and colors. These nets are UV protected and have excellent tensile strength.

Hexagonal SIN nudo
 Cuadrada SIN nudo
 Cuadrada CON nudo

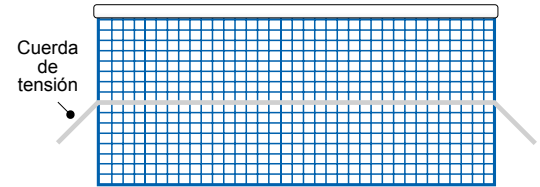
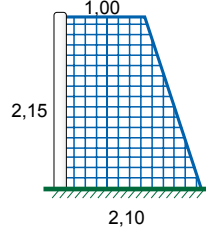
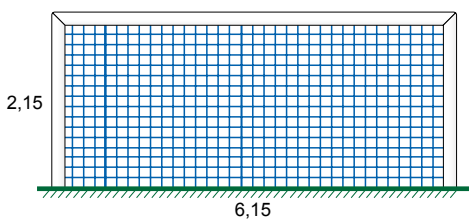

Producto Product	Descripción Description	Medidas Size				Color Color					
		A	B	C	D						

▶ Redes sin nudo polipropileno Polypropylene knotless netting

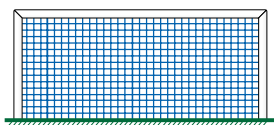

2111050811	JG. F7 EN748 - C PPM 3 M50	6,15	2,15	1,00	2,10	11	22	33	44	55	66
2111051111	JG. F7 EN748 - C PPM 3 M100	6,15	2,15	1,00	2,10	11	22	33	44	55	66
2111051211	JG. F7 EN748 - C PPM 3 M120	6,15	2,15	1,00	2,10	11	22	33	44	55	66

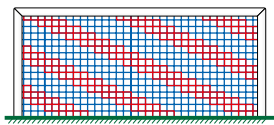

2111070811	JG. F7 EN748 - B PPM 4 M50	6,15	2,15	1,00	2,10	11	22	33	44	55	66
2111071111	JG. F7 EN748 - B PPM 4 M100	6,15	2,15	1,00	2,10	11	22	33	44	55	66
2111071211	JG. F7 EN748 - B PPM 4 M120	6,15	2,15	1,00	2,10	11	22	33	44	55	66

2111091111	JG. F7 EN748 - A PPM 5 M100	6,15	2,15	1,00	2,10	11	22	33	44	55	66
------------	-----------------------------	------	------	------	------	----	----	----	----	----	----

2111071211	JG. F7 EN748 - B PPM 4 M120 BICOLOR	6,15	2,15	1,00	2,10	1/4	2/4	3/4		5/6	4/6
							2/3	3/6		2/5	

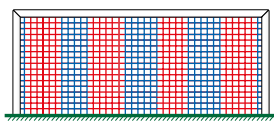

2111072911	JG. F7 EN748 - B PPM 4 HEX 50 BICOLOR	6,15	2,15	1,00	2,10	1/4	2/4	3/4		5/6	4/6
							2/3	3/6		2/5	

2111072211	JG. F7 EN748 - B PPM 4 HEX 120 BICOLOR	6,15	2,15	1,00	2,10	1/4	2/4	3/4	44	5/6	4/6
							2/3	3/6		2/5	

▶ Redes con nudo poliéster Polyester knotted netting

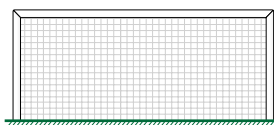

2115061111	JG. F7 EN748 - B PES 3,5 M100	6,15	2,15	1,00	2,10					44	
2115061211	JG. F7 EN748 - B PES 3,5 M120	6,15	2,15	1,00	2,10					44	

▶ Redes con nudo poliamida Polyamide knotted netting

2112061211	JG. F7 EN748 - B PA 3,5 M120	6,15	2,15	1,00	2,10					44	
2112081211	JG. F7 EN748 - B PA 4,5 M120	6,15	2,15	1,00	2,10					44	

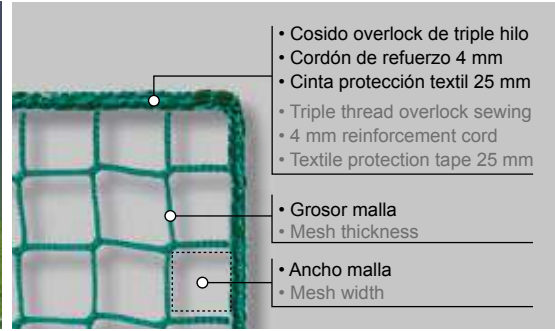
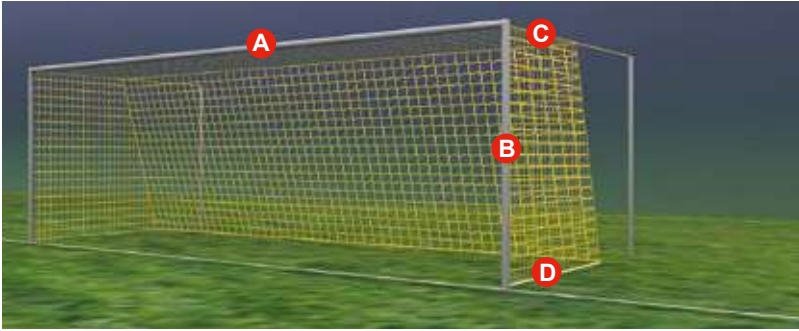

DESCRIPCIÓN: Juego de redes para porterías en polipropileno de alta tenacidad, poliamida y poliéster. Cumplen con las exigencias de la normativa aplicable en cada deporte. Instalación rápida y sencilla. Gran variedad en grosores, mallas y colores. Gran resistencia a la tracción y resistente a rayos UV.

DESCRIPTION: Pair of football goal nets made of high tenacity polypropylene, polyamide and polyester. They comply with the requirements of the regulations of each specific sport. They are easy and fast to install. We have a great assortment in many thicknesses, meshes and colors. These nets are UV protected and have excellent tensile strength.

Hexagonal SIN nudo
 Cuadrada SIN nudo
 Cuadrada CON nudo

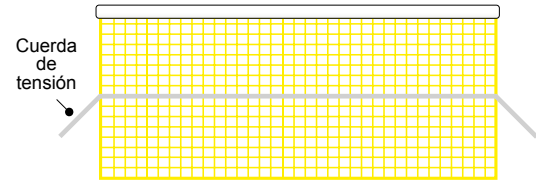
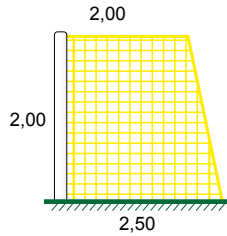
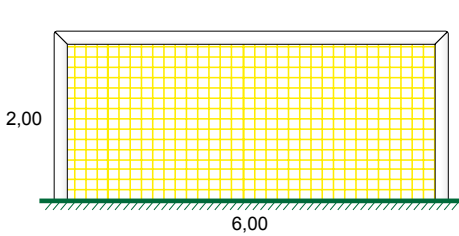

Producto Product	Descripción Description	Medidas Size				Color Color					
		A	B	C	D						

▶ Redes sin nudo polipropileno Polypropylene knotless netting

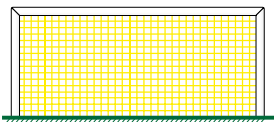

2111050806	JG. F7 EN748 - C PPM 3 M50	6,00	2,00	2,00	2,50	11	22	33	44	55	66
2111051106	JG. F7 EN748 - C PPM 3 M100	6,00	2,00	2,00	2,50	11	22	33	44	55	66
2111051206	JG. F7 EN748 - C PPM 3 M120	6,00	2,00	2,00	2,50	11	22	33	44	55	66

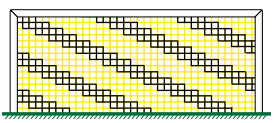

2111070806	JG. F7 EN748 - B PPM 4 M50	6,00	2,00	2,00	2,50	11	22	33	44	55	66
2111071106	JG. F7 EN748 - B PPM 4 M100	6,00	2,00	2,00	2,50	11	22	33	44	55	66
2111071206	JG. F7 EN748 - B PPM 4 M120	6,00	2,00	2,00	2,50	11	22	33	44	55	66

2111091106	JG. F7 EN748 - A PPM 5 M100	6,00	2,00	2,00	2,50	11	22	33	44	55	66
------------	-----------------------------	------	------	------	------	----	----	----	----	----	----

2111071206	JG. F7 EN748 - B PPM 4 M120 BICOLOR	6,00	2,00	2,00	2,50	1/4	2/4	3/4	4/4	5/6	6/6
						2/3	3/6	2/5			

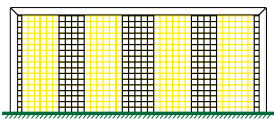

2111072906	JG. F7 EN748 - B PPM 4 HEX 50 BICOLOR	6,00	2,00	2,00	2,50	1/4	2/4	3/4	4/4	5/6	6/6
						2/3	3/6	2/5			

2111072206	JG. F7 EN748 - B PPM 4 HEX 120 BICOLOR	6,00	2,00	2,00	2,50	1/4	2/4	3/4	4/4	5/6	6/6
						2/3	3/6	2/5			

▶ Redes con nudo poliéster Polyester knotted netting

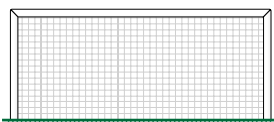

2115061106	JG. F7 EN748 - B PES 3,5 M100	6,00	2,00	2,00	2,50					44	
2115061206	JG. F7 EN748 - B PES 3,5 M120	6,00	2,00	2,00	2,50					44	

▶ Redes con nudo poliamida Polyamide knotted netting

2112061206	JG. F7 EN748 - B PA 3,5 M120	6,00	2,00	2,00	2,50					44	
2112081206	JG. F7 EN748 - B PA 4,5 M120	6,00	2,00	2,00	2,50					44	

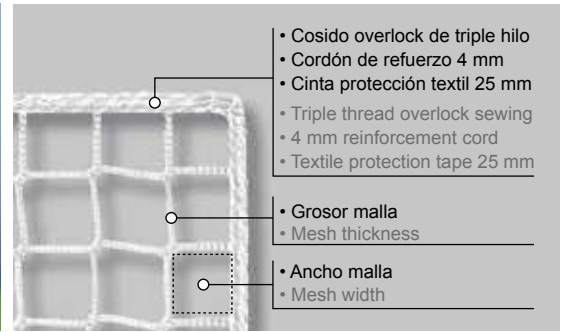
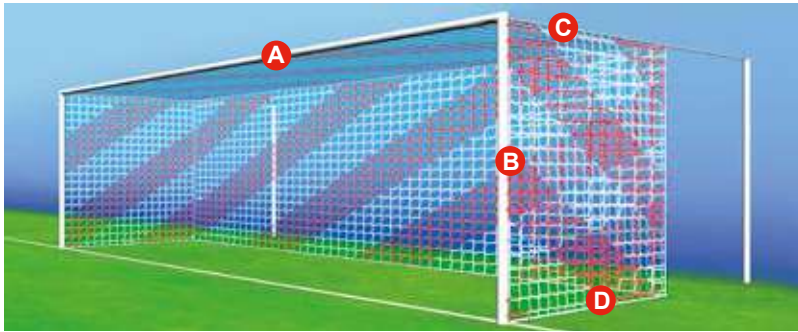

DESCRIPCIÓN: Juego de redes para porterías en polipropileno de alta tenacidad, poliamida y poliéster. Cumplen con las exigencias de la normativa aplicable en cada deporte. Instalación rápida y sencilla. Gran variedad en grosores, mallas y colores. Gran resistencia a la tracción y resistente a rayos UV.

DESCRIPTION: Pair of football goal nets made of high tenacity polypropylene, polyamide and polyester. They comply with the requirements of the regulations of each specific sport. They are easy and fast to install. We have a great assortment in many thicknesses, meshes and colors. These nets are UV protected and have excellent tensile strength.

Hexagonal SIN nudo
 Cuadrada SIN nudo
 Cuadrada CON nudo

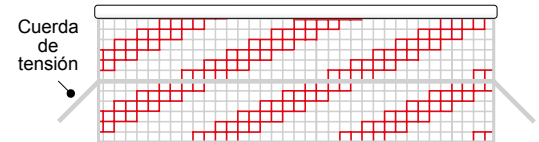
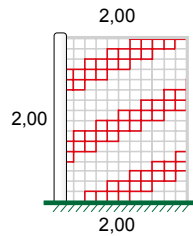
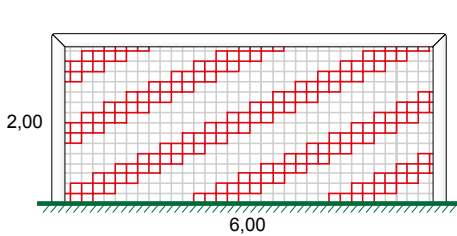

Producto Product	Descripción Description	Medidas Size				Color Color					
		A	B	C	D						

▶ **Redes sin nudo polipropileno Polypropylene knotless netting**

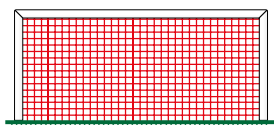

2111050814	JG. F7 EN748 - C PPM 3 M50	6,00	2,00	2,00	2,00	11	22	33	44	55	66
2111051114	JG. F7 EN748 - C PPM 3 M100	6,00	2,00	2,00	2,00	11	22	33	44	55	66
2111051214	JG. F7 EN748 - C PPM 3 M120	6,00	2,00	2,00	2,00	11	22	33	44	55	66

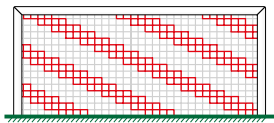

2111070814	JG. F7 EN748 - B PPM 4 M50	6,00	2,00	2,00	2,00	11	22	33	44	55	66
2111071114	JG. F7 EN748 - B PPM 4 M100	6,00	2,00	2,00	2,00	11	22	33	44	55	66
2111071214	JG. F7 EN748 - B PPM 4 M120	6,00	2,00	2,00	2,00	11	22	33	44	55	66

2111091114	JG. F7 EN748 - A PPM 5 M100	6,00	2,00	2,00	2,00	11	22	33	44	55	66
------------	-----------------------------	------	------	------	------	----	----	----	----	----	----

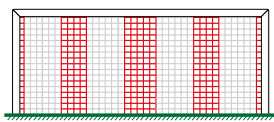

2111071214	JG. F7 EN748 - B PPM 4 M120 BICOLOR	6,00	2,00	2,00	2,00	1/4	2/4	3/4		5/6	4/6
							2/3	3/6		2/5	

2111072914	JG. F7 EN748 - B PPM 4 HEX 50 BICOLOR	6,00	2,00	2,00	2,00	1/4	2/4	3/4		5/6	4/6
							2/3	3/6		2/5	

2111072214	JG. F7 EN748 - B PPM 4 HEX 120 BICOLOR	6,00	2,00	2,00	2,00	1/4	2/4	3/4	44	5/6	4/6
							2/3	3/6		2/5	

▶ **Redes con nudo poliéster Polyester knotted netting**

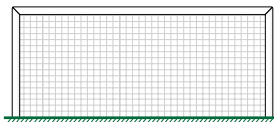

2115061114	JG. F7 EN748 - B PES 3,5 M100	6,00	2,00	2,00	2,00					44	
2115061214	JG. F7 EN748 - B PES 3,5 M120	6,00	2,00	2,00	2,00					44	

▶ **Redes con nudo poliamida Polyamide knotted netting**

2112061214	JG. F7 EN748 - B PA 3,5 M120	6,00	2,00	2,00	2,00					44	
2112081214	JG. F7 EN748 - B PA 4,5 M120	6,00	2,00	2,00	2,00					44	

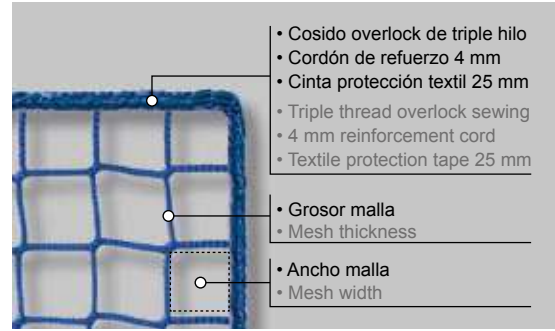
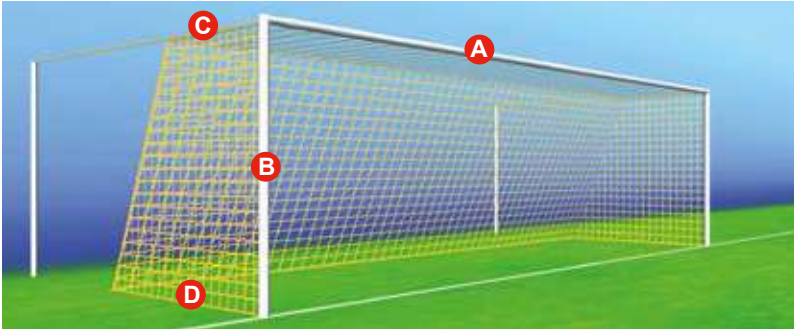

DESCRIPCIÓN: Juego de redes para porterías en polipropileno de alta tenacidad, poliamida y poliéster. Cumplen con las exigencias de la normativa aplicable en cada deporte. Instalación rápida y sencilla. Gran variedad en grosores, mallas y colores. Gran resistencia a la tracción y resistente a rayos UV.

DESCRIPTION: Pair of football goal nets made of high tenacity polypropylene, polyamide and polyester. They comply with the requirements of the regulations of each specific sport. They are easy and fast to install. We have a great assortment in many thicknesses, meshes and colors. These nets are UV protected and have excellent tensile strength.

Hexagonal SIN nudo
 Cuadrada SIN nudo
 Cuadrada CON nudo

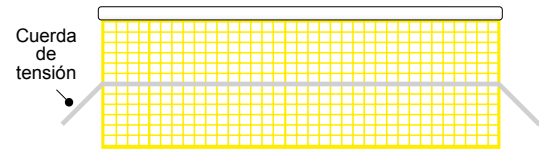
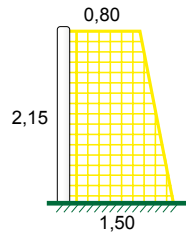
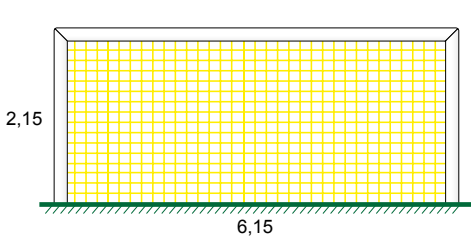

Producto Product	Descripción Description	Medidas Size				Color Color					
		A	B	C	D						

▶ Redes sin nudo polipropileno Polypropylene knotless netting

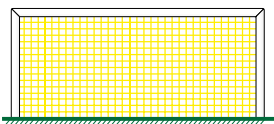

2111050827	JG. F7 EN748 - C PPM 3 M50	6,15	2,15	0,80	1,50	11	22	33	44	55	66
2111051127	JG. F7 EN748 - C PPM 3 M100	6,15	2,15	0,80	1,50	11	22	33	44	55	66
2111051227	JG. F7 EN748 - C PPM 3 M120	6,15	2,15	0,80	1,50	11	22	33	44	55	66

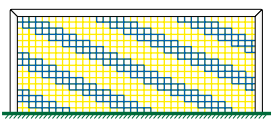

2111070827	JG. F7 EN748 - B PPM 4 M50	6,15	2,15	0,80	1,50	11	22	33	44	55	66
2111071127	JG. F7 EN748 - B PPM 4 M100	6,15	2,15	0,80	1,50	11	22	33	44	55	66
2111071227	JG. F7 EN748 - B PPM 4 M120	6,15	2,15	0,80	1,50	11	22	33	44	55	66

2111091127	JG. F7 EN748 - A PPM 5 M100	6,15	2,15	0,80	1,50	11	22	33	44	55	66
------------	-----------------------------	------	------	------	------	----	----	----	----	----	----

2111071227	JG. F7 EN748 - B PPM 4 M120 BICOLOR	6,15	2,15	0,80	1,50	1/4	2/4	3/4	5/6	4/6	
						2/3	3/6	2/5			

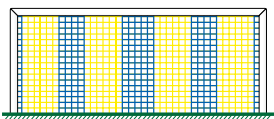

2111072927	JG. F7 EN748 - B PPM 4 HEX 50 BICOLOR	6,15	2,15	0,80	1,50	1/4	2/4	3/4	5/6	4/6	
						2/3	3/6	2/5			

2111072227	JG. F7 EN748 - B PPM 4 HEX 120 BICOLOR	6,15	2,15	0,80	1,50	1/4	2/4	3/4	44	5/6	4/6
						2/3	3/6	2/5			

▶ Redes con nudo poliéster Polyester knotted netting

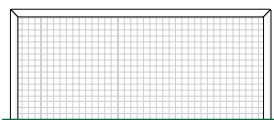

2115061127	JG. F7 EN748 - B PES 3,5 M100	6,15	2,15	0,80	1,50				44		
2115061227	JG. F7 EN748 - B PES 3,5 M120	6,15	2,15	0,80	1,50				44		

▶ Redes con nudo poliamida Polyamide knotted netting

2112061227	JG. F7 EN748 - B PA 3,5 M120	6,15	2,15	0,80	1,50				44		
2112081227	JG. F7 EN748 - B PA 4,5 M120	6,15	2,15	0,80	1,50				44		

Fútbol 5

Football 5

Norma Europea
EN-748

FÚTBOL 5
Con cuerda de
tensión 6/8 mm Ø
With tension rope 6/8 mm ø

Medidas Size 5,15 x 2,05 x 0,80 x 2,00m

Página 17 Tarifa. Page 17 Price List.

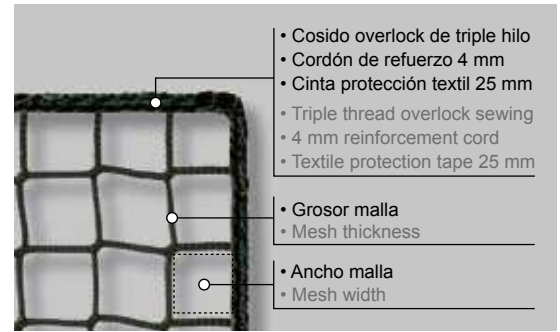
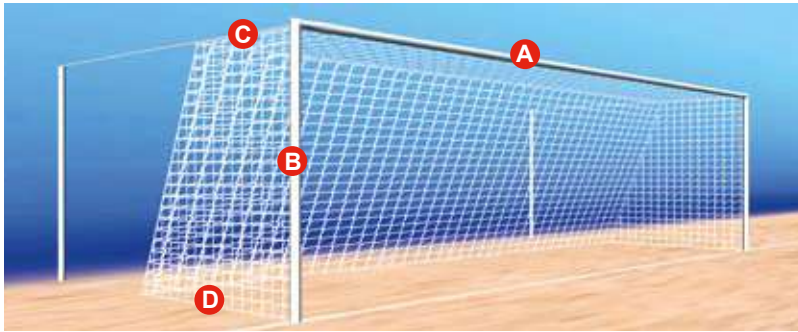

DESCRIPCIÓN: Juego de redes para porterías en polipropileno de alta tenacidad, poliamida y poliéster. Cumplen con las exigencias de la normativa aplicable en cada deporte. Instalación rápida y sencilla. Gran variedad en grosores, mallas y colores. Gran resistencia a la tracción y resistente a rayos UV.

DESCRIPTION: Pair of football goal nets made of high tenacity polypropylene, polyamide and polyester. They comply with the requirements of the regulations of each specific sport. They are easy and fast to install. We have a great assortment in many thicknesses, meshes and colors. These nets are UV protected and have excellent tensile strength.

Hexagonal SIN nudo
 Cuadrada SIN nudo
 Cuadrada CON nudo

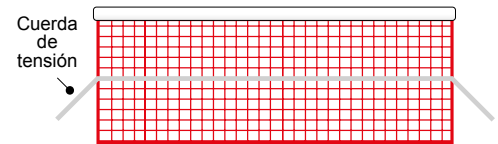
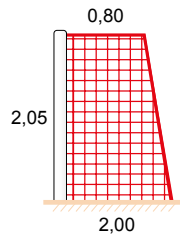
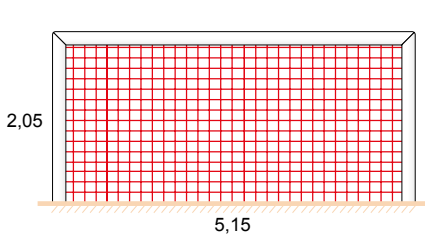

Producto Product	Descripción Description	Medidas Size				Color Color					
		A	B	C	D						

▶ Redes sin nudo polipropileno Polypropylene knotless netting

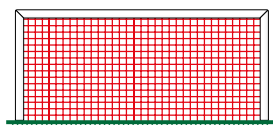

2121050811	JG. F5 EN748 - C PPM 3 M50	5,15	2,05	0,80	2,00	11	22	33	44	55	66
2121051111	JG. F5 EN748 - C PPM 3 M100	5,15	2,05	0,80	2,00	11	22	33	44	55	66
2121051211	JG. F5 EN748 - C PPM 3 M120	5,15	2,05	0,80	2,00	11	22	33	44	55	66

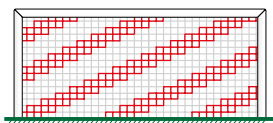

2121070811	JG. F5 EN748 - B PPM 4 M50	5,15	2,05	0,80	2,00	11	22	33	44	55	66
2121071111	JG. F5 EN748 - B PPM 4 M100	5,15	2,05	0,80	2,00	11	22	33	44	55	66
2121071211	JG. F5 EN748 - B PPM 4 M120	5,15	2,05	0,80	2,00	11	22	33	44	55	66

2121091111	JG. F5 EN748 - A PPM 5 M100	5,15	2,05	0,80	2,00	11	22	33	44	55	66
------------	-----------------------------	------	------	------	------	----	----	----	----	----	----

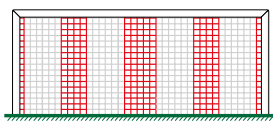

2121071211	JG. F5 EN748 - B PPM 4 M120 BICOLOR	5,15	2,05	0,80	2,00	1/4	2/4	3/4		5/6	4/6
							2/3	3/6		2/5	

2121072911	JG. F5 EN748 - B PPM 4 HEX 50 BICOLOR	5,15	2,05	0,80	2,00	1/4	2/4	3/4		5/6	4/6
							2/3	3/6		2/5	

2121072211	JG. F5 EN748 - B PPM 4 HEX 120 BICOLOR	5,15	2,05	0,80	2,00	1/4	2/4	3/4	44	5/6	4/6
							2/3	3/6		2/5	

▶ Redes con nudo poliéster Polyester knotted netting

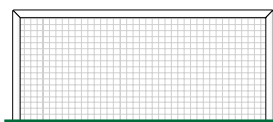

2125061111	JG. F5 EN748 - B PES 3,5 M100	5,15	2,05	0,80	2,00					44	
2125061211	JG. F5 EN748 - B PES 3,5 M120	5,15	2,05	0,80	2,00					44	

▶ Redes con nudo poliamida Polyamide knotted netting

2122061211	JG. F5 EN748 - B PA 3,5 M120	5,15	2,05	0,80	2,00					44	
2122081211	JG. F5 EN748 - B PA 4,5 M120	5,15	2,05	0,80	2,00					44	

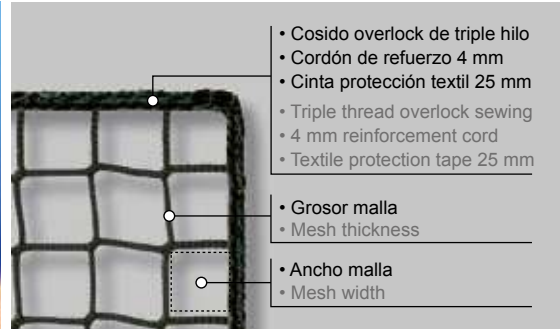
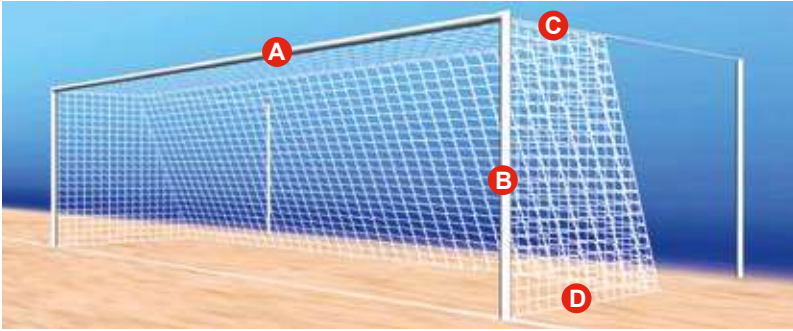

DESCRIPCIÓN: Juego de redes para porterías en polipropileno de alta tenacidad, poliamida y poliéster. Cumplen con las exigencias de la normativa aplicable en cada deporte. Instalación rápida y sencilla. Gran variedad en grosores, mallas y colores. Gran resistencia a la tracción y resistente a rayos UV.

DESCRIPTION: Pair of football goal nets made of high tenacity polypropylene, polyamide and polyester. They comply with the requirements of the regulations of each specific sport. They are easy and fast to install. We have a great assortment in many thicknesses, meshes and colors. These nets are UV protected and have excellent tensile strength.

Hexagonal SIN nudo
 Cuadrada SIN nudo
 Cuadrada CON nudo

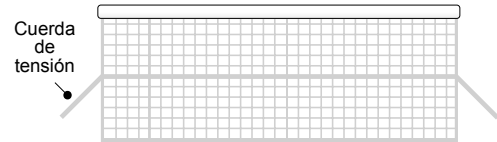
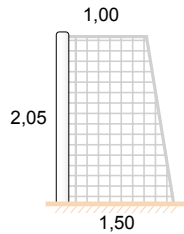
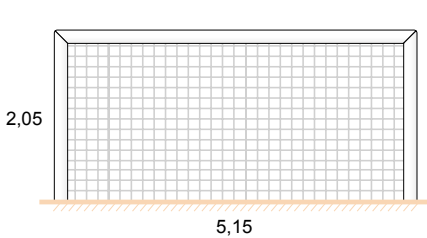

Producto Product	Descripción Description	Medidas Size				Color Color					
		A	B	C	D						

▶ Redes sin nudo polipropileno Polypropylene knotless netting

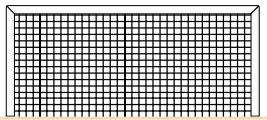

2121050812	JG. F5 EN748 - C PPM 3 M50	5,15	2,05	1,00	1,50	11	22	33	44	55	66
2121051112	JG. F5 EN748 - C PPM 3 M100	5,15	2,05	1,00	1,50	11	22	33	44	55	66
2121051212	JG. F5 EN748 - C PPM 3 M120	5,15	2,05	1,00	1,50	11	22	33	44	55	66

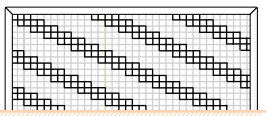

2121070812	JG. F5 EN748 - B PPM 4 M50	5,15	2,05	1,00	1,50	11	22	33	44	55	66
2121071112	JG. F5 EN748 - B PPM 4 M100	5,15	2,05	1,00	1,50	11	22	33	44	55	66
2121071212	JG. F5 EN748 - B PPM 4 M120	5,15	2,05	1,00	1,50	11	22	33	44	55	66

2121091112	JG. F5 EN748 - A PPM 5 M100	5,15	2,05	1,00	1,50	11	22	33	44	55	66
------------	-----------------------------	------	------	------	------	----	----	----	----	----	----

2121071212	JG. F5 EN748 - B PPM 4 M120 BICOLOR	5,15	2,05	1,00	1,50	1/4	2/4	3/4	5/6	4/6	
							2/3	3/6	2/5		

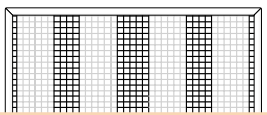

2121072912	JG. F5 EN748 - B PPM 4 HEX 50 BICOLOR	5,15	2,05	1,00	1,50	1/4	2/4	3/4	5/6	4/6	
							2/3	3/6	2/5		

2121072212	JG. F5 EN748 - B PPM 4 HEX 120 BICOLOR	5,15	2,05	1,00	1,50	1/4	2/4	3/4	44	5/6	4/6
							2/3	3/6	2/5		

▶ Redes con nudo poliéster Polyester knotted netting

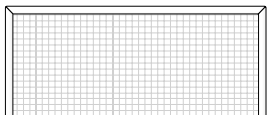

2125061112	JG. F5 EN748 - B PES 3,5 M100	5,15	2,05	1,00	1,50				44		
2125061212	JG. F5 EN748 - B PES 3,5 M120	5,15	2,05	1,00	1,50				44		

▶ Redes con nudo poliamida Polyamide knotted netting

2122061212	JG. F5 EN748 - B PA 3,5 M120	5,15	2,05	1,00	1,50				44		
2122081212	JG. F5 EN748 - B PA 4,5 M120	5,15	2,05	1,00	1,50				44		

Fútbol 5

Football 5

Norma Europea
EN-748

FÚTBOL 5
Con cuerda de
tensión 6/8 mm Ø
With tension rope 6/8 mm ø

Medidas Size 5,15 x 2,05 x 1,00 x 2,10m

Página 18 Tarifa. Page 18 Price List.

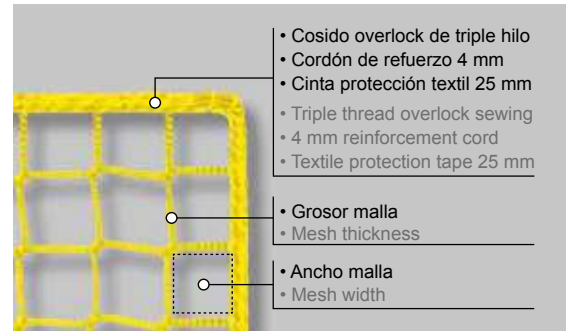
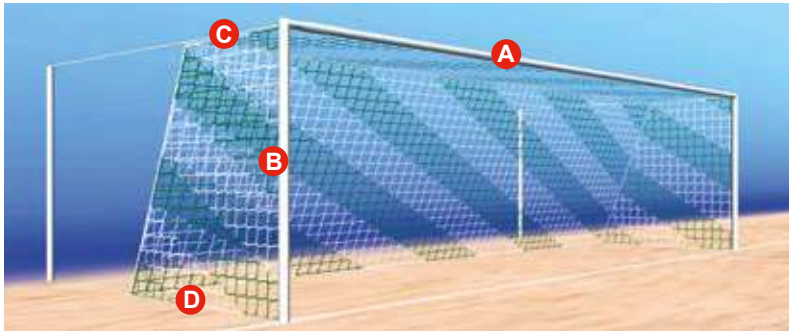

DESCRIPCIÓN: Juego de redes para porterías en polipropileno de alta tenacidad, poliamida y poliéster. Cumplen con las exigencias de la normativa aplicable en cada deporte. Instalación rápida y sencilla. Gran variedad en grosores, mallas y colores. Gran resistencia a la tracción y resistente a rayos UV.

DESCRIPTION: Pair of football goal nets made of high tenacity polypropylene, polyamide and polyester. They comply with the requirements of the regulations of each specific sport. They are easy and fast to install. We have a great assortment in many thicknesses, meshes and colors. These nets are UV protected and have excellent tensile strength.

Hexagonal SIN nudo
 Cuadrada SIN nudo
 Cuadrada CON nudo

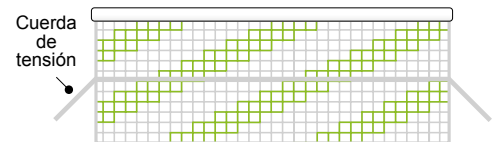
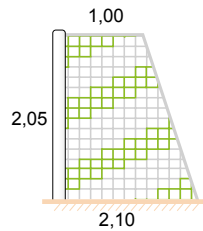
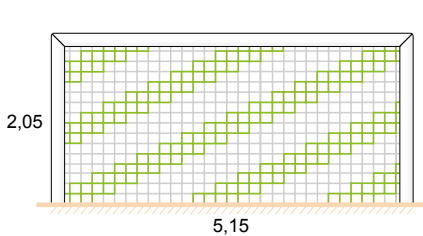

Producto Product	Descripción Description	Medidas Size				Color Color					
		A	B	C	D						

▶ Redes sin nudo polipropileno Polypropylene knotless netting

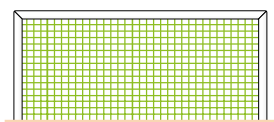

2121050813	JG. F5 EN748 - C PPM 3 M50	5,15	2,05	1,00	2,10	11	22	33	44	55	66
2121051113	JG. F5 EN748 - C PPM 3 M100	5,15	2,05	1,00	2,10	11	22	33	44	55	66
2121051213	JG. F5 EN748 - C PPM 3 M120	5,15	2,05	1,00	2,10	11	22	33	44	55	66

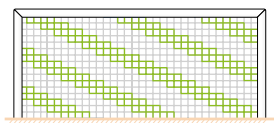

2121070813	JG. F5 EN748 - B PPM 4 M50	5,15	2,05	1,00	2,10	11	22	33	44	55	66
2121071113	JG. F5 EN748 - B PPM 4 M100	5,15	2,05	1,00	2,10	11	22	33	44	55	66
2121071213	JG. F5 EN748 - B PPM 4 M120	5,15	2,05	1,00	2,10	11	22	33	44	55	66

2121091113	JG. F5 EN748 - A PPM 5 M100	5,15	2,05	1,00	2,10	11	22	33	44	55	66
------------	-----------------------------	------	------	------	------	----	----	----	----	----	----

2121071213	JG. F5 EN748 - B PPM 4 M120 BICOLOR	5,15	2,05	1,00	2,10	1/4	2/4	3/4		5/6	4/6
							2/3	3/6		2/5	

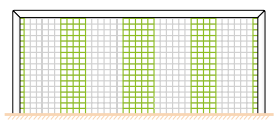

2121072913	JG. F5 EN748 - B PPM 4 HEX 50 BICOLOR	5,15	2,05	1,00	2,10	1/4	2/4	3/4		5/6	4/6
							2/3	3/6		2/5	

2121072213	JG. F5 EN748 - B PPM 4 HEX 120 BICOLOR	5,15	2,05	1,00	2,10	1/4	2/4	3/4	44	5/6	4/6
							2/3	3/6		2/5	

▶ Redes con nudo poliéster Polyester knotted netting

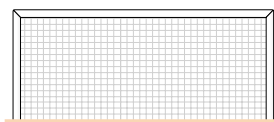

2125061113	JG. F5 EN748 - B PES 3,5 M100	5,15	2,05	1,00	2,10					44	
2125061213	JG. F5 EN748 - B PES 3,5 M120	5,15	2,05	1,00	2,10					44	

▶ Redes con nudo poliamida Polyamide knotted netting

2122061213	JG. F5 EN748 - B PA 3,5 M120	5,15	2,05	1,00	2,10					44	
2122081213	JG. F5 EN748 - B PA 4,5 M120	5,15	2,05	1,00	2,10					44	

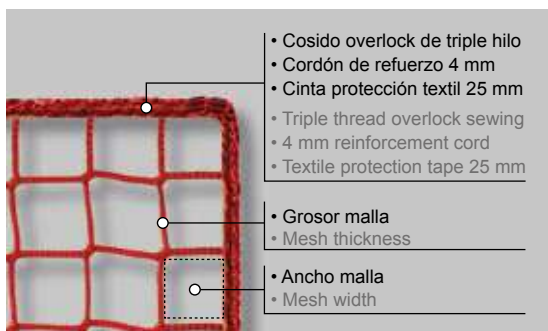

DESCRIPCIÓN: Juego de redes para porterías en polipropileno de alta tenacidad, poliamida y poliéster. Cumplen con las exigencias de la normativa aplicable en cada deporte. Instalación rápida y sencilla. Gran variedad en grosores, mallas y colores. Gran resistencia a la tracción y resistente a rayos UV.

DESCRIPTION: Pair of football goal nets made of high tenacity polypropylene, polyamide and polyester. They comply with the requirements of the regulations of each specific sport. They are easy and fast to install. We have a great assortment in many thicknesses, meshes and colors. These nets are UV protected and have excellent tensile strength.

Hexagonal SIN nudo
 Cuadrada SIN nudo
 Cuadrada CON nudo

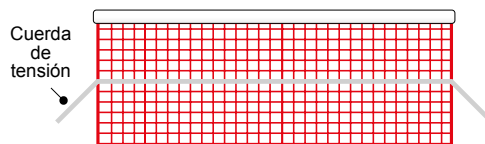
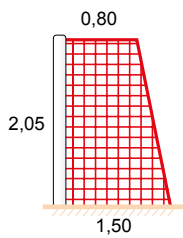
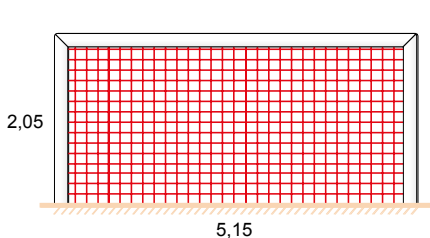

Producto Product	Descripción Description	Medidas Size				Color					
		A	B	C	D						

▶ Redes sin nudo polipropileno Polypropylene knotless netting

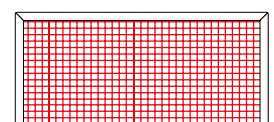

2121050814	JG. F5 EN748 - C PPM 3 M50	5,15	2,05	0,80	1,50	11	22	33	44	55	66
2121051114	JG. F5 EN748 - C PPM 3 M100	5,15	2,05	0,80	1,50	11	22	33	44	55	66
2121051214	JG. F5 EN748 - C PPM 3 M120	5,15	2,05	0,80	1,50	11	22	33	44	55	66

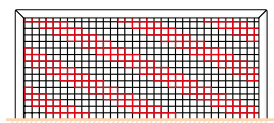

2121070814	JG. F5 EN748 - B PPM 4 M50	5,15	2,05	0,80	1,50	11	22	33	44	55	66
2121071114	JG. F5 EN748 - B PPM 4 M100	5,15	2,05	0,80	1,50	11	22	33	44	55	66
2121071214	JG. F5 EN748 - B PPM 4 M120	5,15	2,05	0,80	1,50	11	22	33	44	55	66

2121091114	JG. F5 EN748 - A PPM 5 M100	5,15	2,05	0,80	1,50	11	22	33	44	55	66
------------	-----------------------------	------	------	------	------	----	----	----	----	----	----

2121071214	JG. F5 EN748 - B PPM 4 M120 BICOLOR	5,15	2,05	0,80	1,50	1/4	2/4	3/4	5/6	4/6	
						2/3	3/6	2/5			

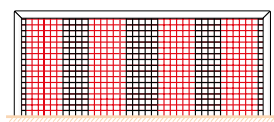

2121072914	JG. F5 EN748 - B PPM 4 HEX 50 BICOLOR	5,15	2,05	0,80	1,50	1/4	2/4	3/4	5/6	4/6	
						2/3	3/6	2/5			

2121072214	JG. F5 EN748 - B PPM 4 HEX 120 BICOLOR	5,15	2,05	0,80	1,50	1/4	2/4	3/4	44	5/6	4/6
						2/3	3/6	2/5			

▶ Redes con nudo poliéster Polyester knotted netting

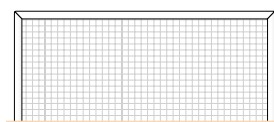

2125061114	JG. F5 EN748 - B PES 3,5 M100	5,15	2,05	0,80	1,50				44		
2125061214	JG. F5 EN748 - B PES 3,5 M120	5,15	2,05	0,80	1,50				44		

▶ Redes con nudo poliamida Polyamide knotted netting

2122061214	JG. F5 EN748 - B PA 3,5 M120	5,15	2,05	0,80	1,50				44		
2122081214	JG. F5 EN748 - B PA 4,5 M120	5,15	2,05	0,80	1,50				44		

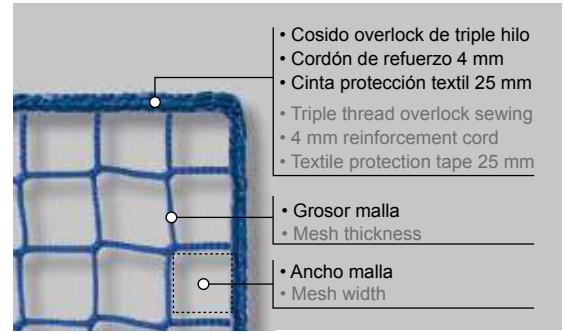
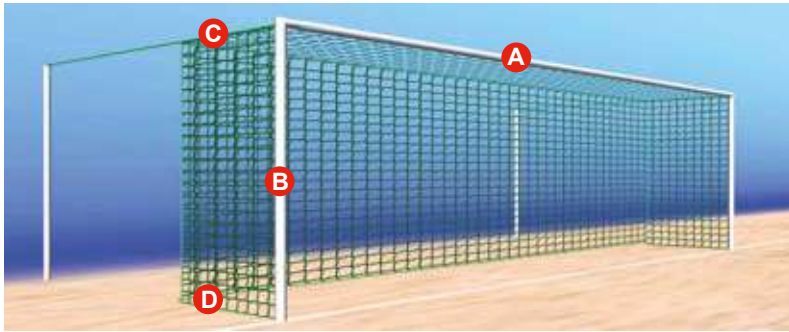

DESCRIPCIÓN: Juego de redes para porterías en polipropileno de alta tenacidad, poliamida y poliéster. Cumplen con las exigencias de la normativa aplicable en cada deporte. Instalación rápida y sencilla. Gran variedad en grosores, mallas y colores. Gran resistencia a la tracción y resistente a rayos UV.

DESCRIPTION: Pair of football goal nets made of high tenacity polypropylene, polyamide and polyester. They comply with the requirements of the regulations of each specific sport. They are easy and fast to install. We have a great assortment in many thicknesses, meshes and colors. These nets are UV protected and have excellent tensile strength.

Hexagonal SIN nudo
 Cuadrada SIN nudo
 Cuadrada CON nudo

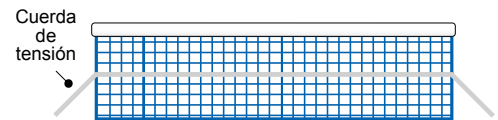
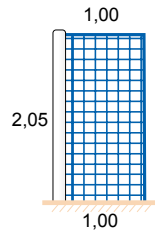
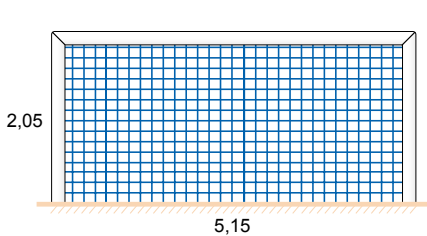

Producto Product	Descripción Description	Medidas Size				Color Color					
		A	B	C	D						

Redes sin nudo polipropileno Polypropylene knotless netting

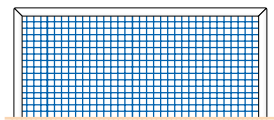

2121050816	JG. F5 EN748 - C PPM 3 M50	5,15	2,05	1,00	1,00	11	22	33	44	55	66
2121051116	JG. F5 EN748 - C PPM 3 M100	5,15	2,05	1,00	1,00	11	22	33	44	55	66
2121051216	JG. F5 EN748 - C PPM 3 M120	5,15	2,05	1,00	1,00	11	22	33	44	55	66

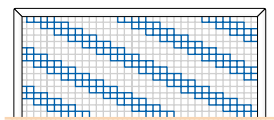

2121070816	JG. F5 EN748 - B PPM 4 M50	5,15	2,05	1,00	1,00	11	22	33	44	55	66
2121071116	JG. F5 EN748 - B PPM 4 M100	5,15	2,05	1,00	1,00	11	22	33	44	55	66
2121071216	JG. F5 EN748 - B PPM 4 M120	5,15	2,05	1,00	1,00	11	22	33	44	55	66

2121091116	JG. F5 EN748 - A PPM 5 M100	5,15	2,05	1,00	1,00	11	22	33	44	55	66
------------	-----------------------------	------	------	------	------	----	----	----	----	----	----

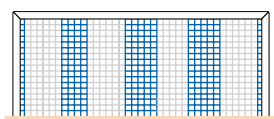

2121071216	JG. F5 EN748 - B PPM 4 M120 BICOLOR	5,15	2,05	1,00	1,00	1/4	2/4	3/4		5/6	4/6
							2/3	3/6		2/5	

2121072916	JG. F5 EN748 - B PPM 4 HEX 50 BICOLOR	5,15	2,05	1,00	1,00	1/4	2/4	3/4		5/6	4/6
							2/3	3/6		2/5	

2121072216	JG. F5 EN748 - B PPM 4 HEX 120 BICOLOR	5,15	2,05	1,00	1,00	1/4	2/4	3/4	44	5/6	4/6
							2/3	3/6		2/5	

Redes con nudo poliéster Polyester knotted netting

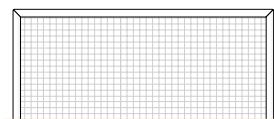

2125061116	JG. F5 EN748 - B PES 3,5 M100	5,15	2,05	1,00	1,00					44	
2125061216	JG. F5 EN748 - B PES 3,5 M120	5,15	2,05	1,00	1,00					44	

Redes con nudo poliamida Polyamide knotted netting

2122061216	JG. F5 EN748 - B PA 3,5 M120	5,15	2,05	1,00	1,00					44	
2122081216	JG. F5 EN748 - B PA 4,5 M120	5,15	2,05	1,00	1,00					44	

Fútbol playa

Beach soccer

NIDE 2013	R NORMAS REGLAMENTARIAS	FÚTBOL PLAYA	FTP
--------------	-------------------------------	-----------------	-----

Medidas Size
5,50 x 2,20 x 0,80 x 1,50m

Página 19 Tarifa. Page 19 Price List.

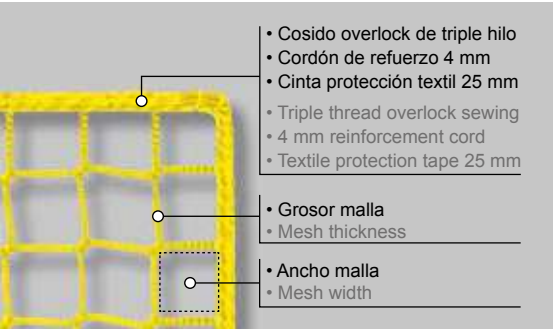
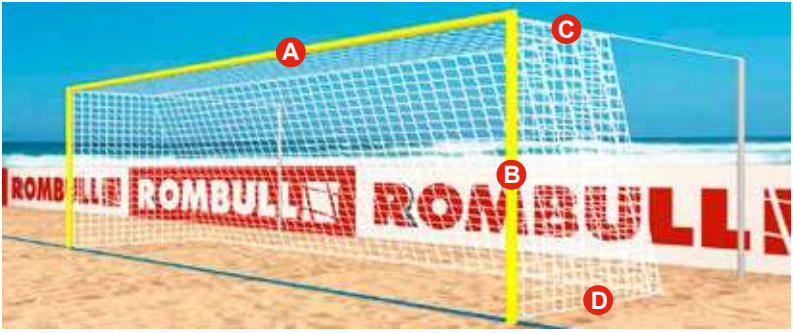

DESCRIPCIÓN: Juego de redes para porterías en polipropileno de alta tenacidad, poliamida y poliéster. Cumplen con las exigencias de la normativa aplicable en cada deporte. Instalación rápida y sencilla. Gran variedad en grosores, mallas y colores. Gran resistencia a la tracción y resistente a rayos UV.

DESCRIPTION: Pair of football goal nets made of high tenacity polypropylene, polyamide and polyester. They comply with the requirements of the regulations of each specific sport. They are easy and fast to install. We have a great assortment in many thicknesses, meshes and colors. These nets are UV protected and have excellent tensile strength.

- Hexagonal SIN nudo
- Cuadrada SIN nudo
- Cuadrada CON nudo

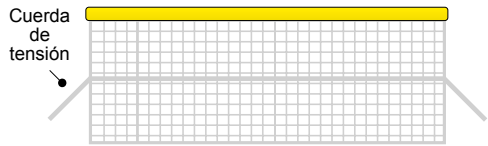
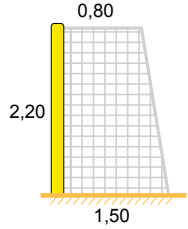
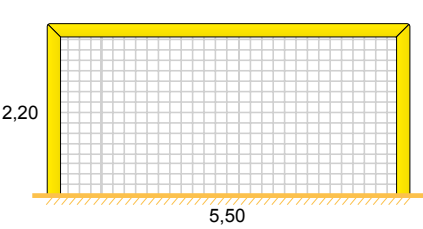

Producto Product	Descripción Description	Medidas Size				Color Color
		A	B	C	D	

▶ Redes sin nudo polipropileno Polypropylene knotless netting

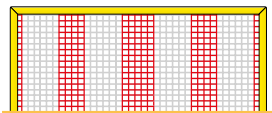

	2401072244	JG. F-PLAYA PPM 4 HEX 120	5,50	2,20	0,80	1,50		44			
	2401072244	JG. F-PLAYA PPM 4 HEX 120 BICOLOR	5,50	2,20	0,80	1,50	1/4	2/4	3/4	5/6	4/6
							2/3	3/6	2/5		



Mini porterías

Mini goals

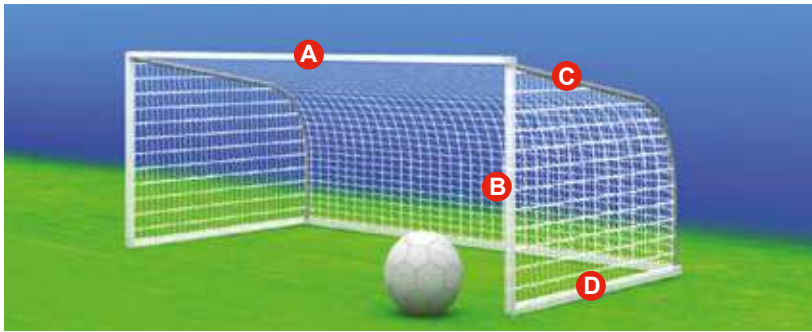

Medidas Size

1,20 x 0,80 x 0,70 x 0,70m

1,80 x 1,20 x 0,70 x 0,70m

2,40 x 1,60 x 1,00 x 1,00m

Página 20 Tarifa. Page 20 Price List.

DESCRIPCIÓN: Juego de redes para porterías en polipropileno de alta tenacidad, poliamida y poliéster. Cumplen con las exigencias de la normativa aplicable en cada deporte. Instalación rápida y sencilla. Gran variedad en grosores, mallas y colores. Gran resistencia a la tracción y resistente a rayos UV.

DESCRIPTION: Pair of football goal nets made of high tenacity polypropylene, polyamide and polyester. They comply with the requirements of the regulations of each specific sport. They are easy and fast to install. We have a great assortment in many thicknesses, meshes and colors. These nets are UV protected and have excellent tensile strength.

Producto Product	Descripción Description	Medidas Size				Color Color
		A	B	C	D	

► Redes sin nudo polipropileno Polypropylene knotless netting

1,20x0,80x0,70x0,70m

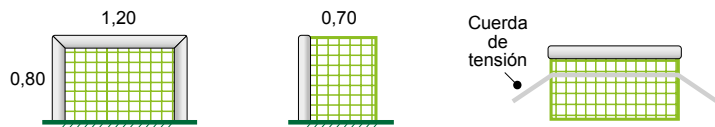

2311050867	JG. MINI PORTERÍA PPM 3 M50	1,20	0,80	0,70	0,70	11	44	66
2311051167	JG. MINI PORTERÍA PPM 3 M100	1,20	0,80	0,70	0,70	11	44	66
2311070867	JG. MINI PORTERÍA PPM 4 M50	1,20	0,80	0,70	0,70	11	44	66
2311071167	JG. MINI PORTERÍA PPM 4 M100	1,20	0,80	0,70	0,70	11	44	66

1,80x1,20x0,70x0,70m

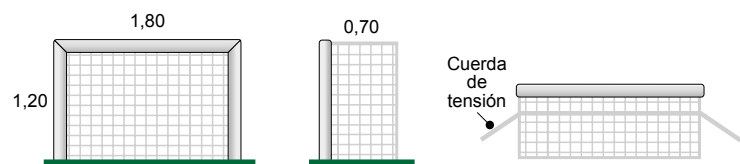

2311050868	JG. MINI PORTERÍA PPM 3 M50	1,80	1,20	0,70	0,70	11	44	66
2311051168	JG. MINI PORTERÍA PPM 3 M100	1,80	1,20	0,70	0,70	11	44	66
2311070868	JG. MINI PORTERÍA PPM 4 M50	1,80	1,20	0,70	0,70	11	44	66
2311071168	JG. MINI PORTERÍA PPM 4 M100	1,80	1,20	0,70	0,70	11	44	66

2,40x1,60x1,00x1,00m

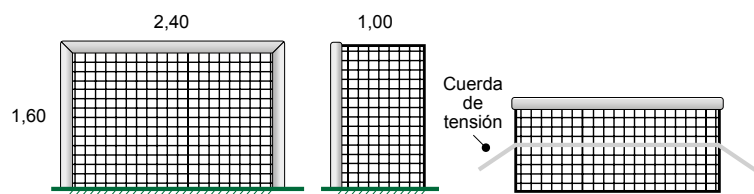

2311050869	JG. MINI PORTERÍA PPM 3 M50	2,40	1,60	1,00	1,00	11	44	66
2311051169	JG. MINI PORTERÍA PPM 3 M100	2,40	1,60	1,00	1,00	11	44	66
2311070869	JG. MINI PORTERÍA PPM 4 M50	2,40	1,60	1,00	1,00	11	44	66
2311071169	JG. MINI PORTERÍA PPM 4 M100	2,40	1,60	1,00	1,00	11	44	66

Balonmano - Fútbol sala

Handball - Football indoor

Norma Europea
EN-749

BALONMANO
Con cuerda de
tensión 6/8 mm Ø
With tension rope 6/8 mm Ø

Medidas Size

3,00 x 2,80 x 1,00 x 1,00m

3,00 x 2,00 x 1,00 x 1,00m

Página 20 Tarifa. Page 20 Price List.

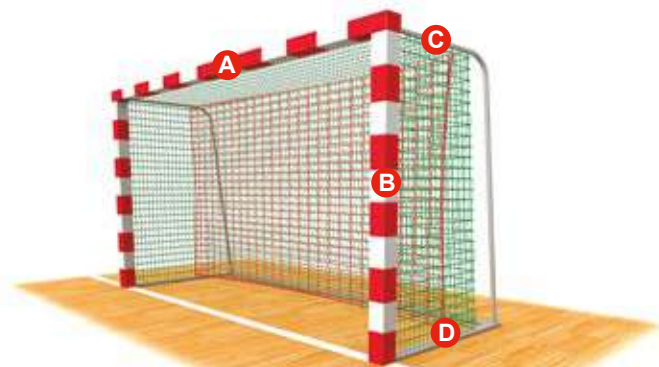

DESCRIPCIÓN: Juego de redes para porterías en polipropileno de alta tenacidad, poliamida y poliéster. Cumplen con las exigencias de la normativa aplicable en cada deporte. Instalación rápida y sencilla. Gran variedad en grosores, mallas y colores. Gran resistencia a la tracción y resistente a rayos UV.

DESCRIPTION: Pair of football goal nets made of high tenacity polypropylene, polyamide and polyester. They comply with the requirements of the regulations of each specific sport. They are easy and fast to install. We have a great assortment in many thicknesses, meshes and colors. These nets are UV protected and have excellent tensile strength.

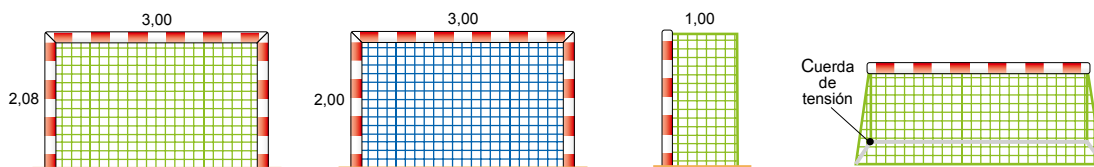

Producto Product	Descripción Description	Medidas Size				Color Color
		A	B	C	D	

▶ Redes sin nudo polipropileno Polypropylene knotless netting

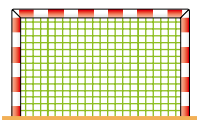

2151051126	JG. BALONMANO EN749 - C PPM 3 M100 PRO	3,00	2,08	1,00	1,00	11	22	33	44	55	66
2151071126	JG. BALONMANO EN749 - B PPM 4 M100 PRO	3,00	2,08	1,00	1,00	11	22	33	44	55	66
2151091126	JG. BALONMANO EN749 - A PPM 5 M100 PRO	3,00	2,08	1,00	1,00	11	22	33	44	55	66

Producto Product	Descripción Description	Medidas Size				Color Color
		A	B	C	D	

▶ Redes sin nudo polipropileno Polypropylene knotless netting

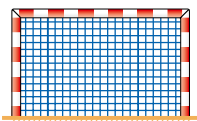

2151051120	JG. BALONMANO EN749 - C PPM 3MM M100	3,00	2,00	1,00	1,00	11	22	33	44	55	66
2151071120	JG. BALONMANO EN749 - B PPM 4MM M100	3,00	2,00	1,00	1,00	11	22	33	44	55	66
2151091120	JG. BALONMANO EN749 - A PPM 5MM M100	3,00	2,00	1,00	1,00	11	22	33	44	55	66

Producto Product	Descripción Description	Medidas Size				Color Color
		A	B	C	D	

▶ Redes con nudo poliéster Polyester knotted netting

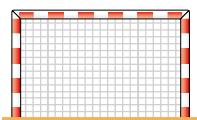

2155051120	JG. BALONMANO EN749 - B PES 3,5MM M100	3,00	2,00	1,00	1,00				44		
------------	--	------	------	------	------	--	--	--	----	--	--

Producto Product	Descripción Description	Medidas Size				Color Color
		A	B	C	D	

▶ Redes con nudo poliamida Polyamide knotted netting

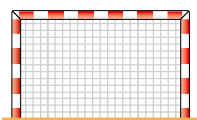

2152051120	JG. BALONMANO EN749 - B PA 3,5MM M100	3,00	2,00	1,00	1,00				44		
2152081120	JG. BALONMANO EN749 - A PA 4,5MM M100	3,00	2,00	1,00	1,00				44		

Balonmano - Fútbol sala

Handball - Football indoor

Norma Europea **EN-749** **BALONMANO**
 Con cuerda de tensión 6/8 mm Ø
 With tension rope 6/8 mm ø

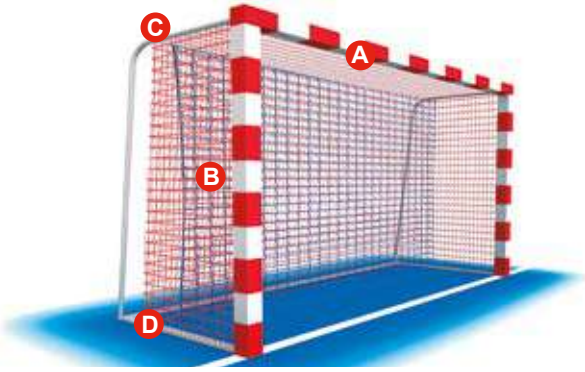

Medidas Size
3,00 x 2,00 x 1,00 x 2,00m
3,00 x 2,00 x 0,80 x 2,00m
3,00 x 2,00 x 0,80 x 1,20m

Página 21 Tarifa. Page 21 Price List.

DESCRIPCIÓN: Juego de redes para porterías en polipropileno de alta tenacidad, poliamida y poliéster. Cumplen con las exigencias de la normativa aplicable en cada deporte. Instalación rápida y sencilla. Gran variedad en grosores, mallas y colores. Gran resistencia a la tracción y resistente a rayos UV.

DESCRIPTION: Pair of football goal nets made of high tenacity polypropylene, polyamide and polyester. They comply with the requirements of the regulations of each specific sport. They are easy and fast to install. We have a great assortment in many thicknesses, meshes and colors. These nets are UV protected and have excellent tensile strength.

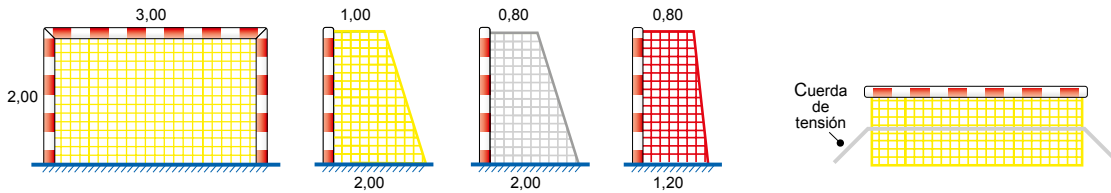

Producto Product	Descripción Description	Medidas Size				Color Color					
		A	B	C	D						

▶ Redes sin nudo polipropileno Polypropylene knotless netting

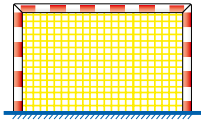

2151051151	JG. BM EN749 - C PPM 3 M100	3,00	2,00	1,00	2,00	11	22	33	44	55	66
2151071151	JG. BM EN749 - B PPM 4 M100	3,00	2,00	1,00	2,00	11	22	33	44	55	66
2151091151	JG. BM EN749 - A PPM 5 M100	3,00	2,00	1,00	2,00	11	22	33	44	55	66

Producto Product	Descripción Description	Medidas Size				Color Color					
		A	B	C	D						

▶ Redes sin nudo polipropileno Polypropylene knotless netting

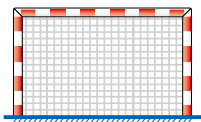

2151051152	JG. BM EN749 - C PPM 3 M100	3,00	2,00	0,80	2,00	11	22	33	44	55	66
2151071152	JG. BM EN749 - B PPM 4 M100	3,00	2,00	0,80	2,00	11	22	33	44	55	66
2151091152	JG. BM EN749 - A PPM 5 M100	3,00	2,00	0,80	2,00	11	22	33	44	55	66

Producto Product	Descripción Description	Medidas Size				Color Color					
		A	B	C	D						

▶ Redes sin nudo polipropileno Polypropylene knotless netting

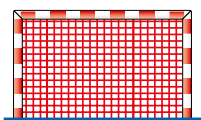

2151051155	JG. BM EN749 - C PPM 3 M100	3,00	2,00	0,80	1,20	11	22	33	44	55	66
2151071155	JG. BM EN749 - B PPM 4 M100	3,00	2,00	0,80	1,20	11	22	33	44	55	66
2151091155	JG. BM EN749 - A PPM 5 M100	3,00	2,00	0,80	1,20	11	22	33	44	55	66

Balonmano - Fútbol sala

Handball - Football indoor

Norma Europea
EN-749

BALONMANO
Con cuerda de
tensión 6/8 mm Ø
With tension rope 6/8 mm ø

Medidas Size
3,00 x 2,00 x 0,80 x 1,00m

Página 21 Tarifa. Page 21 Price List.

CORTINA AMORTIGUADORA
Muffling curtain

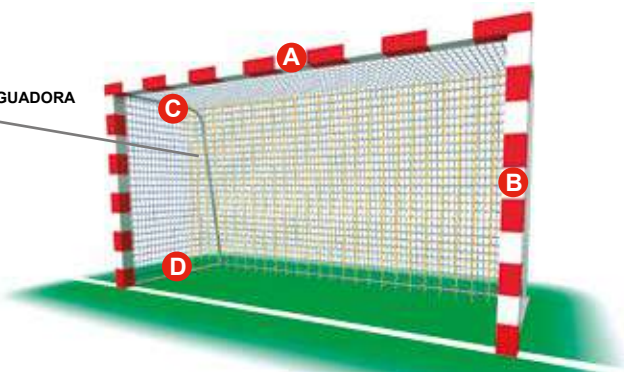

DESCRIPCIÓN: Juego de redes para porterías en polipropileno de alta tenacidad, poliamida y poliéster. Cumplen con las exigencias de la normativa aplicable en cada deporte. Instalación rápida y sencilla. Gran variedad en grosores, mallas y colores. Gran resistencia a la tracción y resistente a rayos UV.

DESCRIPTION: Pair of football goal nets made of high tenacity polypropylene, polyamide and polyester. They comply with the requirements of the regulations of each specific sport. They are easy and fast to install. We have a great assortment in many thicknesses, meshes and colors. These nets are UV protected and have excellent tensile strength.

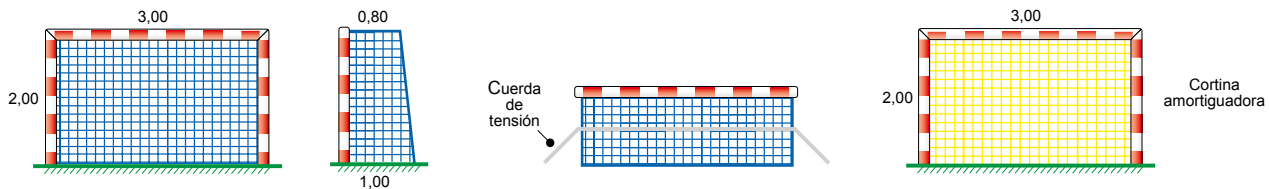

Producto Product	Descripción Description	Medidas Size				Color Color					
		A	B	C	D						

▶ Redes sin nudo polipropileno Polypropylene knotless netting

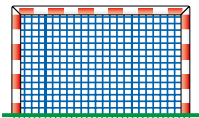

2151051119	JG. BM EN749 - C PPM 3 M100	3,00	2,00	0,80	1,00	11	22	33	44	55	66
2151071119	JG. BM EN749 - B PPM 4 M100	3,00	2,00	0,80	1,00	11	22	33	44	55	66
2151091119	JG. BM EN749 - A PPM 5 M100	3,00	2,00	0,80	1,00	11	22	33	44	55	66

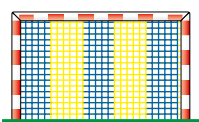

2151072919	JG. BM EN749 - B PPM 4 HEX50	3,00	2,00	0,80	1,00					44	
2151072919	JG. BM EN749 - B PPM 4 HEX50 BICOLOR	3,00	2,00	0,80	1,00	1/4	2/4	3/4	5/6	4/6	
						2/3	3/6	2/5			

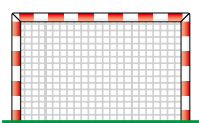

▶ Redes con nudo poliéster Polyester knotless netting

2155051119	JG. BALONMANO PES 3,5 M100	3,00	2,00	0,80	1,00					44	
------------	----------------------------	------	------	------	------	--	--	--	--	----	--

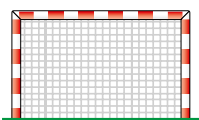

▶ Redes con nudo poliamida Polyamide knotted netting

2152051119	JG. BALONMANO PA 3,5 M100	3,00	2,00	0,80	1,00					44	
2152081119	JG. BALONMANO PA 4,5 M100	3,00	2,00	0,80	1,00					44	

Cortina amortiguadora

Muffling curtain

Producto Product	Descripción Description	Medidas Size				Color Color					
		A	B	C	D						

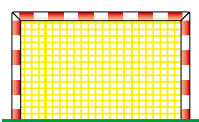

▶ Redes sin nudo polipropileno Polypropylene knotless netting

2151051137	JG. CORTINA AMORTIG PPM 3 M100	3,00	2,00	-	-	11	22	33	44	55	66
2151071137	JG. CORTINA AMORTIG PPM 4 M100	3,00	2,00	-	-	11	22	33	44	55	66

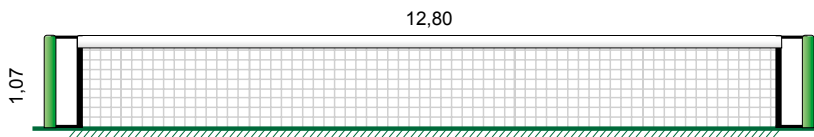

Cuadrada SIN nudo



216107061566 UD.TENIS ALTA COMP. C-PES SUPERIOR UT. HIGH COMP. TENNIS C-PES SUPERIOR

Confeccionada con hilo de polipropileno de alta tenacidad, red de 4mm de grosor, ancho de malla de 43mm. Banda superior de poliéster blanco, cinta de poliéster negro en los laterales y en la parte inferior de la red. Dos enganches a cada lado compuesto de tensor plástico y cuerda de tensión de 5mm. Cable de acero plastificado de 6mm y varillas de fibra de vidrio insertadas en los laterales.

Confetionned with high tenacity yarn of polypropylene, 4mm thickness yarn mesh size 43mm. White polyester tape on top, black polyester tape on both sides and bottom. Two tensioning devices on both sides made of plastic tensor and 5mm rope. Steel cable coated 6mm and fibre glass rods inserted on both sides.



216105062766 UD. TENIS TORNEO C-PES UT. MATCH TENNIS C-PES

Confeccionada con hilo de polipropileno de alta tenacidad, red de 3mm de grosor, ancho de malla de 43mm. Banda superior de poliéster blanco, ribete de poliéster negro en los laterales y en la parte inferior de la red. Un ollado en cada esquina superior de la red y cuerda de tensión doble de 3mm. Cable de acero plastificado de 5mm.

Confetionned with high tenacity yarn of polypropylene, 3mm thickness yarn mesh size 43mm. White polyester tape on top, sides and bottom stitched with polyester tape. One eyelet on both sides of the tape and double tension rope 3mm. Steel cable coated 5mm.



216105060166 UD. TENIS TORNEO C-PVC UT. MATCH TENNIS C-PVC

Confeccionada con hilo de polipropileno de alta tenacidad, red de 3mm de grosor, ancho de malla de 43mm. Banda superior de PVC blanco, ribete de poliéster negro en los laterales y en la parte inferior de la red. Un ollado en cada esquina superior de la red y cuerda de tensión doble de 3mm. Cable de acero plastificado de 5mm.

Confetionned with high tenacity yarn of polypropylene, 3mm thickness yarn mesh size 43mm. White PVC tape on top, sides and bottom stitched with polyester tape. One eyelet on both sides of the tape and double tension rope 3mm. Steel cable coated 5mm.



216105061866 UD. TENIS TORNEO C-PES SUPERIOR UT. MATCH TENNIS C-PES SUPERIOR

Confeccionada con hilo de polipropileno de alta tenacidad, red de 3mm de grosor, ancho de malla de 43mm. Banda superior de poliéster blanco, cinta de poliéster negro en los laterales y ribete de poliéster negro en la parte inferior de la red. Un ollado en cada esquina de la red y cuerda de tension doble de 3mm. Cable de acero plastificado de 5mm.

Confetionned with high tenacity yarn of polypropylene, 3mm thickness yarn mesh size 43mm. White polyester tape on top, black polyester tape on sides, bottom stitched with polyester tape. One eyelet on both sides of the tape and double tension rope 3mm. Steel cable coated 5mm.

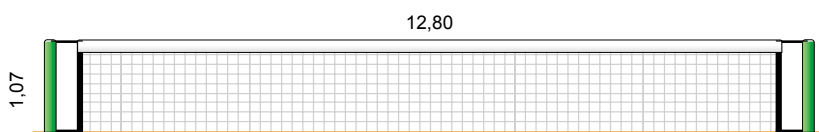

Cuadrada SIN nudo



216105062866

UD. TENIS TORNEO C-PVC SUPERIOR UT. MATCH TENNIS C-PVC SUPERIOR

Confeccionada con hilo de polipropileno de alta tenacidad, red de 3mm de grosor, ancho de malla de 43mm. Banda superior de PVC blanco, cinta de poliéster en los laterales y ribete de poliéster negro en el inferior de la red. Un ollado en cada esquina de la red y cuerda de tensión doble de 3mm. Cable de acero plastificado de 5mm.

Confetionned with high tenacity yarn of polypropylene, 3mm thickness yarn mesh size 43mm. White PVC tape on top, black polyester tape on sides, bottom stitched with polyester tape. One eyelet on both sides of the tape and double tension rope 3mm. Steel cable coated 5mm.



216107061866

UD. TENIS MASTER C-PES SUPERIOR UT. MASTER TENNIS C-PES SUPERIOR

Confeccionada con hilo de polipropileno de alta tenacidad, red de 4mm de grosor, ancho de malla de 43mm. Banda superior de poliéster blanco, cinta de poliéster en los laterales y ribete de poliéster negro en el inferior de la red. Un ollado en cada esquina de la red y cuerda de tensión doble de 3mm. Cable de acero plastificado de 6mm.

Confetionned with high tenacity yarn of polypropylene, 4mm thickness yarn mesh size 43mm. White PVC tape on top, black polyester tape on sides, bottom stitched with polyester tape. One eyelet on both sides of the tape and double tension rope 3mm. Steel cable coated 6mm.



216107062866

UD. TENIS MASTER C-PVC SUPERIOR UT. MASTER TENNIS C-PVC SUPERIOR

Confeccionada con hilo de polipropileno de alta tenacidad, red de 4mm de grosor, ancho de malla de 43mm. Banda superior de PVC blanco, ribete de poliéster negro en los laterales y en la parte inferior de la red. Un ollado en cada esquina superior de la red y cuerda de tensión doble de 3mm. Cable de acero plastificado de 6mm.

Confetionned with high tenacity yarn of polypropylene, 4mm thickness yarn mesh size 43mm. White PVC tape on top, sides and bottom stitched with polyester tape. One eyelet on both sides of the tape and double tension rope 3mm. Steel cable coated 6mm.



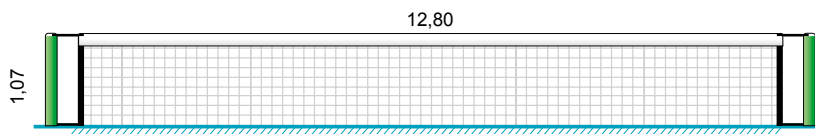

Cuadrada SIN nudo



216505060166 UD.TENIS BÁSICO PE UT. BASIC TENNIS PE

Confeccionada con hilo de polietileno cableado, red de 3mm de grosor, ancho de malla de 43mm. Banda superior de PVC blanco, ribete poliéster negro en los laterales, cuerda de pp de 3mm en la parte inferior pasada malla a malla. Un ollado en cada esquina superior de la red. Cuerda de tensión doble de 3mm. Cable de acero plastificado de 5mm.

Confetionned with twisted polyethylene yarn 3mm thickness, diamond mesh size 43mm. White PVC tape on top, sides stitched with polyester, 3mm yarn passes troughout all the meshes at the botom. One eyelet on both sides of the tape and double tension rope 3mm. Steel cable coated 5mm.

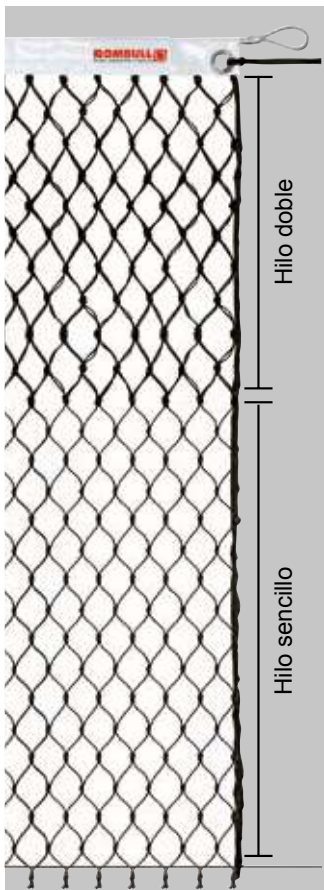

216502060166 UD. TENIS AMISTOSO 10 MALLAS DOBLE C-PVC UT.FRIENDLY TENNIS 10 DOUBLE MESH ESC-PVC

Confeccionada con hilo de polietileno cableado, red de 2mm de grosor, ancho de malla de 43mm. Banda superior de PVC blanco, ribete poliéster negro en los laterales, cuerda de pp de 3mm en la parte inferior pasada malla a malla. Un ollado en cada esquina superior de la red. Cuerda de tensión doble de 3mm. Cable de acero plastificado de 5mm.

Confetionned with twisted polyethylene yarn 2mm thikness, diamond mesh size 43mm. White PVC tape on top, sides stitched with polyester, 3mm yarn passes troughout all the meshes at the botom. One eyelet on both sides of the tape and double tension rope 3mm. Steel cable coated 5mm.



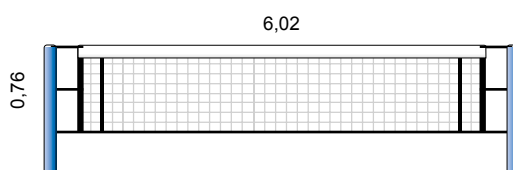

218102010466 UD.BÁDMINTON BÁSICA C-PES SUPERIOR UT. BASIC BADMINTON C-PES SUPERIOR

Confeccionada con hilo de polipropileno de alta tenacidad, red de 2mm de grosor, ancho de malla de 18mm. Banda superior de poliéster blanco, ribete de poliéster negro en los laterales y en la parte inferior de la red. Un ollado en cada esquina superior de la red y cuerda de tensión doble de 3mm. Cable de acero plastificado de 4mm.

Confetionned with high tenacity yarn of polypropylene, 2mm thickness yarn mesh size 18mm. White polyester tape on top, sides and bottom stitched with polyester tape black. One eyelet on both sides of the tape and double tension rope 3mm. Steel cable coated 4mm.



218102010566 UD.BÁDMINTON BÁSICA C-PVC SUPERIOR UT. BASIC BADMINTON C-PVC SUPERIOR

Confeccionada con hilo de polipropileno de alta tenacidad, red de 2mm de grosor, ancho de malla de 18mm. Banda superior de PVC blanco, ribete de poliéster negro en los laterales y en la parte inferior de la red. Un ollado en cada esquina superior de la red y cuerda de tensión doble de 3mm. Cable de acero plastificado de 4mm.

Confetionned with high tenacity yarn of polypropylene, 2mm thickness yarn mesh size 18mm. White PVC tape on top, sides and bottom stitched with polyester tape black. One eyelet on both sides of the tape and double tension rope 3mm. Steel cable coated 4mm.



218102010666 UD.BÁDMINTON ALTA COMPET. C-PES SUPERIOR UT. HIGH COMPET. BADMINTON C-PES SUPERIOR

Confeccionada con hilo de polipropileno de alta tenacidad, red de 2mm de grosor, ancho de malla de 18mm. Banda superior de poliéster blanco, cinta de poliéster negro en los laterales y en la parte inferior de la red. Dos enganches a cada lado compuesto de tensor plástico y cuerda de tensión de 5mm. Cable de acero plastificado de 6mm y varillas de fibra de vidrio insertadas en los laterales.

Confetionned with high tenacity yarn of polypropylene, 2mm thickness yarn mesh size 18mm. White polyester tape on top, sides and bottom with polyester tape black. One eyelet on both sides of the tape and double tension rope 5mm. Steel cable coated 6mm and fibre glass rods inserted at both sides.



Pádel Federación

Padel Federation

En los últimos años el deporte del pádel ha sido visiblemente una de las prácticas deportivas de mayor crecimiento. Desde Rombull, fiel a nuestra filosofía de estar a la cabeza y siempre en constante evolución, nos sentimos tremendamente orgullosos de ser pioneros en coordinar un sistema de HOMOLOGACIONES Y GARANTÍAS DE CALIDAD, junto a la Federación Española de Pádel y el Consejo Superior de Deportes. Esto hará posible ofrecer al consumidor de tan demandado sector la garantía de calidad en todos los productos acorde a las exigencias en Normativa, Reglamento y Seguridad. Fruto de esta colaboración surge el **Manual de buenas prácticas en la instalación y mantenimiento de pistas de pádel**. Dentro de este manual vienen indicados los parámetros que han de cumplir las redes para la práctica del pádel.

During the past few years padel has become one of the most rising sports activities. From Rombull Ronets S.L., we feel every product for being pioneer in coordenating an HOMOLOGATION AND QUALITY GUARANTEE system, in association with Federación Española de Pádel and Consejo Superior de Deportes. This will make possible, the fact of bringing to the consumer the quality guarantee of all the products on such demanded area, according to the needs in Rules, Standards and Safety. Due to this cooperation, an instruction **Guide in Correct Practises of Installations and Manteinace for Padel Courts**, is born. You will find the points that Nets have to acomplish for their correct use in Padel in this Guide.

Características	Valores
Malla de la red - espesor del hilo	Máx. 4 mm Mín. 3 mm
Malla de la red - fuerza de rotura del hilo de la malla	≥ 1080 N
Longitud de la red	10 m
Altura de la red	0,92 m
Banda superior - anchura una vez plegada sobre el cable de tensión	Mín. 50 mm Máx. 63 mm
Banda superior - fuerza de rotura del hilo de cosido	Mín. 50 N
Banda superior - fuerza de rotura del material	≥ 2500 N
Cable de tensión - diámetro	≤ 8 mm
Cable de tensión - tensión mínima a resistir bajo fuerza de tracción	≥ 2290 N durante 10 min.

Mantenimiento

Para alargar el tiempo de vida de nuestras redes, es necesario llevar a cabo una serie de recomendaciones:

- Las redes Rombull llevan protección solar, lo que le proporcionará a la red una resistencia mayor al sol durante un período mayor de tiempo. Nuestras redes no necesitan una limpieza especial, con agua y jabón neutro es más que suficiente.
- Será necesario realizar inspecciones frecuentemente sobre la red, para un mejor mantenimiento de ésta.
- En el momento que se visualicen deterioros, roturas o deformaciones sobre la red que impida una práctica correcta o segura del deporte, debe ser inmediatamente sustituida, ya que podría provocar accidentes en los jugadores o el paso de la pelota a través de ella y provocar un juego deficiente.
- Para el correcto funcionamiento está totalmente desaconsejado sentarse o ejercer una fuerza sobre la red.
- También se desaconseja depositar ningún objeto sobre la red, ni antes ni durante el partido para el buen funcionamiento de esta.

Maintenance

To make our nets last longer it is necessary take some advices:

- Rombull nets have UV solar protection which will make the net more resistant to direct sunlight exposure for a longer period of time.
- Our nets dont need any special treatment for cleaning, just some neutral soap and water is more than what is needed.
- Frequent inspections over the net are very important for a better maintenance.
- When any wrecking, cuts or holes are seen the net must be replaced by a new one that can offer a correct functioning of the sport without risk.
- For an efficient use it is totally not adviced to sit or put any type of force on to the net, as well as, leaning any object on it before, during or after any match.



228107063366 UD. RED PÁDEL RFP CPES UD. RED PÁDEL RFP CPES



10

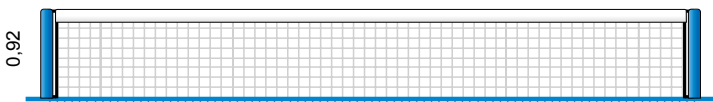

Red confeccionada en sistema raschel con doble frontura, sin nudo, fabricada con hilo multifilamento de polipropileno de alta tenacidad de 300 kilolangleys con protección solar UV, de color negro. Esta red es de 4mm de grosor, con un ancho de malla de 42mm, en confección al cuadro. La banda superior de la red es de poliéster de color blanco, con una anchura de 50mm una vez doblada y cosida sobre la red. Bajo la banda de poliéster se colocará un cable de acero que le dará mayor resistencia y forma a la red. En cada esquina superior de la red existe un ollado, a la que se le pasa una cuerda de poliamida alta tenacidad de 4mm color negro. La longitud de la red, será de 10 metros utilizando postes exteriores, y la altura alcanzará un máximo de 0,92 metros en sus extremos y de 0,88 metros en su centro.

Black colour net confectioned using raschel system, knotless, with double front, manufactured with high tenacity polypropilene multifilament yarn of 300 kilolangleys with UV solar protection. 4mm thick and 42mm of mesh width. With a white polyester superior band that has a 50mm width once folded and sewn to the net. A steel wire will be placed under the white polyester band to make the net more resistant and shaped. On each corner of the net there is an eyelet, through which a black high tenacity 4mm polyamide rope is introduced. The length of the net will be 10 meters using exterior posts and will reach a maximum height of 0,92 meters at its ends and 0,88 meters in the middle.

228107063466 UD. RED PÁDEL RFP CPVC UD. RED PÁDEL RFP CPVC



10

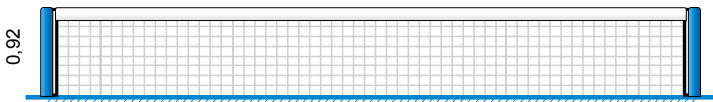

Red confeccionada en sistema raschel con doble frontura, sin nudo, fabricada con hilo multifilamento de polipropileno de alta tenacidad de 300 kilolangleys con protección solar UV, de color negro. Esta red es de 4mm de grosor, con un ancho de malla de 42mm, en confección al cuadro. La banda superior de la red es de PVC de color blanco, con una anchura de 50mm una vez doblada y cosida sobre la red. Bajo la banda de PVC se colocará un cable de acero que le dará mayor resistencia y forma a la red. En cada esquina superior de la red existe un ollado, a la que se le pasa una cuerda de poliamida alta tenacidad de 4mm color negro. La longitud de la red, será de 10 metros utilizando postes exteriores, y la altura alcanzará un máximo de 0,92 metros en sus extremos y de 0,88 metros en su centro.

Black colour net confectioned using raschel system, knotless, with double front, manufactured with high tenacity polypropilene multifilament yarn of 300 kilolangleys with UV solar protection. 4mm thick and 42mm of mesh width. With a white PVC superior band that has a 50mm width once folded and sewn to the net. A steel wire will be placed under the white PVC band to make the net more resistant and shaped. On each corner of the net there is an eyelet, through which a black high tenacity 4mm polyamide rope is introduced. The length of the net will be 10 meters using exterior posts and will reach a maximum height of 0,92 meters at its ends and 0,88 meters in the middle.

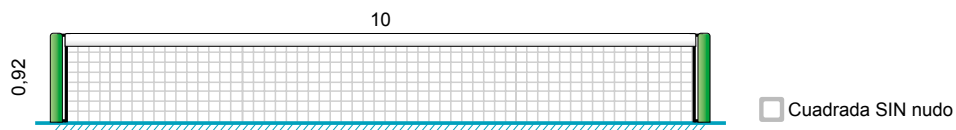

228105062666 UD. PADEL TORNEO C-PVC SUPERIOR UT. MATCH PADEL C-PVC SUPERIOR

Confeccionada con hilo de polipropileno de alta tenacidad, red de 3mm de grosor, ancho de malla de 43mm. Banda superior de PVC blanco, ribete de poliéster negro en los laterales y en la parte inferior de la red. Un ollado en cada esquina superior de la red y cuerda de tensión doble de 3mm. Cable de acero plastificado de 5mm.

Confetionned with high tenacity yarn of polypropylene, 3mm thickness yarn mesh size 43mm. White PVC tape on top, sides and bottom stitched with polyester tape. One eyelet on both sides of the tape and double tension rope 3mm. Steel cable coated 5mm.



228105060766 UD. PADEL TORNEO C-PES SUPERIOR UT. MATCH PADEL C-PES SUPERIOR

Confeccionada con hilo de polipropileno de alta tenacidad, red de 3mm de grosor, ancho de malla de 43mm. Banda superior de poliéster blanco, ribete de poliéster negro en los laterales y en la parte inferior de la red. Un ollado en cada esquina superior de la red y cuerda de tensión doble de 03mm. Cable de acero plastificado de 5mm.

Confetionned with high tenacity yarn of polypropylene, 3mm thickness yarn mesh size 43mm. White polyester tape on top, sides and bottom stitched with polyester tape. One eyelet on both sides of the tape and double tension rope 3mm. Steel cable coated 5mm.



228107062666 UD. PADEL MASTER C-PVC SUPERIOR UT. MASTER PADEL C-PVC SUPERIOR

Confeccionada con hilo de polipropileno de alta tenacidad, red de 4mm de grosor, ancho de malla de 43mm. Banda superior de PVC blanco, ribete de poliéster negro en los laterales y en la parte inferior de la red. Un ollado en cada esquina superior de la red y cuerda de tensión doble de 3mm. Cable de acero plastificado de 6mm.

Confetionned with high tenacity yarn of polypropylene, 4mm thickness yarn mesh size 43mm. White PVC tape on top, sides and bottom stitched with polyester tape. One eyelet on both sides of the tape and double tension rope 3mm. Steel cable coated 6mm.

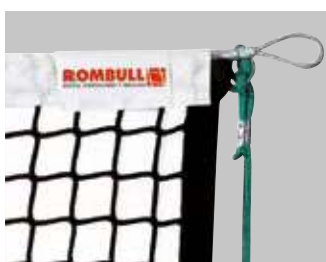

228107063166 UD. PADEL ALTA COMPETICIÓN C-PES SUPERIOR UT. HIGH COMPETITION PADEL C-PES SUPERIOR

Confeccionada con hilo de polipropileno de alta tenacidad, red de 4mm de grosor, ancho de malla de 43mm. Banda superior de poliéster blanco, cinta de poliéster negro en los laterales y en la parte inferior de la red. Dos enganches a cada lado compuesto de tensor plástico y cuerda de tensión de 5mm. Cable de acero plastificado de 6mm y varillas de fibra de vidrio insertadas en los laterales.

Confetionned with high tenacity yarn of polypropylene, 4mm thickness yarn mesh size 43mm. White polyester tape on top, black polyester tape on both sides and bottom. Two tensioning devices on both sides made of plastic tensor and 5mm rope. Steel cable coated 6mm and fibre glass rods inserted on both sides.

Redes de protección superior pádel

Padel superior protection nets

Tipo A1

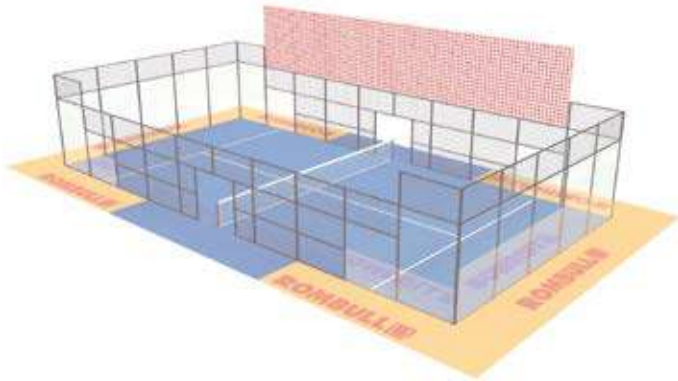

Tipo A2

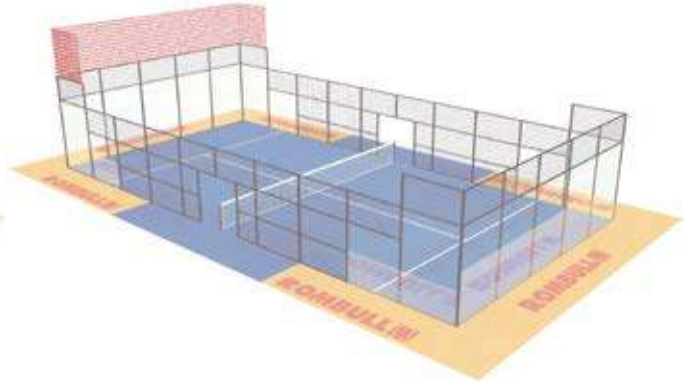

Código Producto Product code	Descripción Description	Hilo ø Yarn ø	Malla # Mesh #	Color Color
---------------------------------	----------------------------	------------------	-------------------	----------------

► **Redes sin nudo polipropileno Polypropylene knotless netting**

2441050604	UD. RED PROTEC. SUP. TIPOA1 PPM	3MM	M42 3X16	66
2441050605	UD RED PROTEC. SUP. TIPO A2 PPM	3MM	M42 2X14	66

Tipo B1



Tipo B2

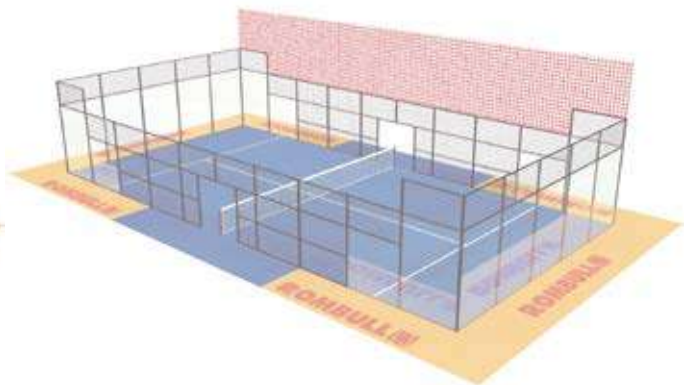

Código Producto Product code	Descripción Description	Hilo ø Yarn ø	Malla # Mesh #	Color Color
---------------------------------	----------------------------	------------------	-------------------	----------------

► **Redes sin nudo polipropileno Polypropylene knotless netting**

2441050606	UD. RED PROTEC. SUP. TIPO B1 PPM	3MM	M42 2X10	66
2441050607	UD RED PROTEC. SUP. TIPO B2 PPM	3MM	M42 3X20	66



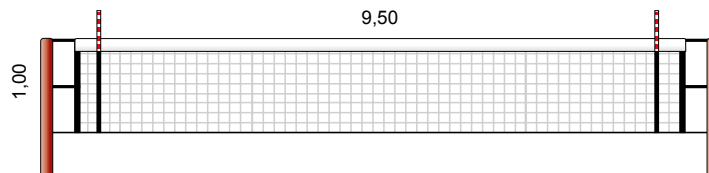
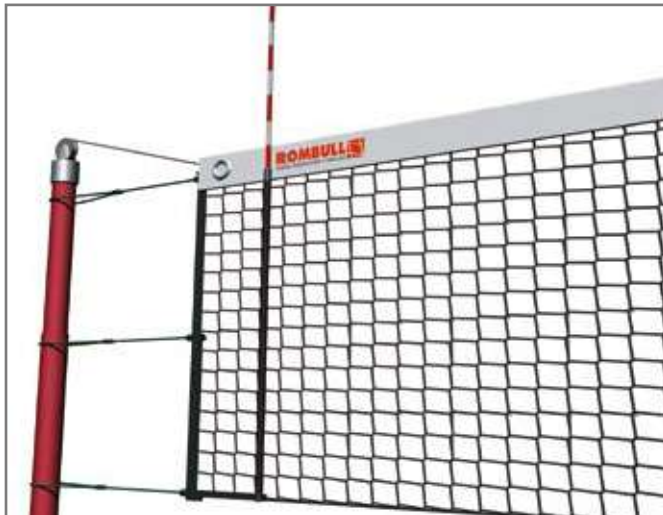

221104112966 UD. VOLEIBOL BÁSICA C-PVC SUPERIOR UT. BASIC VOLLEYBALL C-PVC SUPERIOR

Confeccionada con hilo de polipropileno de alta tenacidad, red de 2,5mm de grosor, ancho de malla de 100mm. Banda superior de PVC blanco, ribete de poliéster negro en los laterales y en la parte inferior de la red. Un ollado en cada esquina superior de la red y cuerda de tensión doble de 3mm. Cable de acero plastificado de 4mm.

Confetionned with high tenacity yarn of polypropylene, 2,5mm thickness yarn mesh size 100mm. White PVC tape on top, sides and bottom stitched with polyester tape. One eyelet on both sides of the tape and double tension rope 3mm. Steel cable coated 4mm. Top tape white PVC, sides and bottom stitched with polyester tape.



221105112966 UD. VOLEIBOL TORNEO C-PVC SUPERIOR UT. MATCH VOLLEYBALL C-PVC SUPERIOR

Confeccionada con hilo de polipropileno de alta tenacidad, red de 3mm de grosor, ancho de malla de 100mm. Banda superior de PVC blanco, ribete de poliéster negro en los laterales y en la parte inferior de la red. Un ollado en cada esquina superior de la red y cuerda de tensión doble de 03mm. Cable de acero plastificado de 5mm.

Confetionned with high tenacity yarn of polypropylene, 3mm thickness yarn mesh size 100mm. White PVC tape on top, sides and bottom stitched with polyester tape. One eyelet on both sides of the tape and double tension rope 3mm. Steel cable coated 5mm.



221105113166 UD. VOLEIBOL TORNEO C-PES SUPERIOR UT. MATCH VOLLEYBALL C-PES SUPERIOR

Confeccionada con hilo de polipropileno de alta tenacidad, red de 3mm de grosor, ancho de malla de 100mm. Banda superior de poliéster blanco, cinta de poliéster negro en los laterales y en la parte inferior de la red. Un ollado en cada esquina de la red y cuerda de tensión doble de 3mm. Cable de acero plastificado de 5mm.

Confetionned with high tenacity yarn of polypropylene, 3mm thickness, mesh size 100mm. White polyester tape on top, black polyester tape sides and bottom. One eyelet on both sides of the tape and double tension rope 3mm. Steel cable coated 5mm.



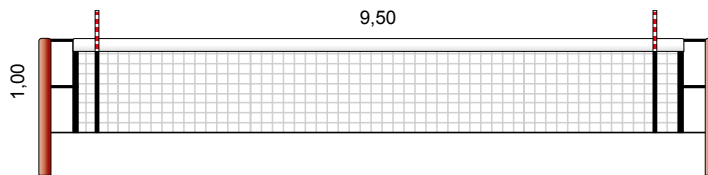
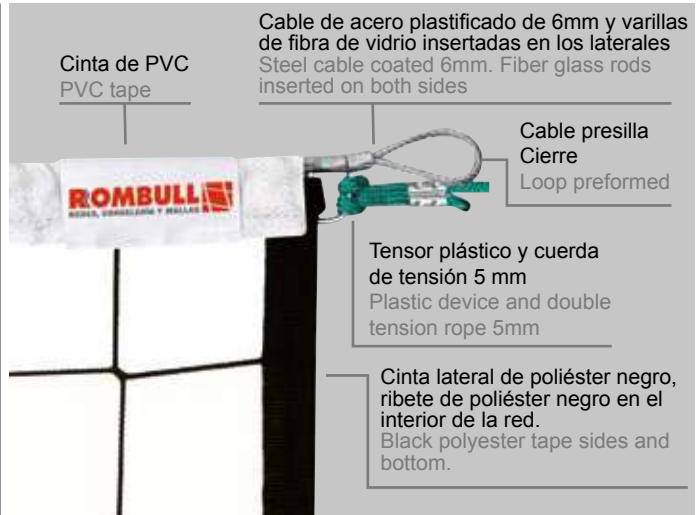
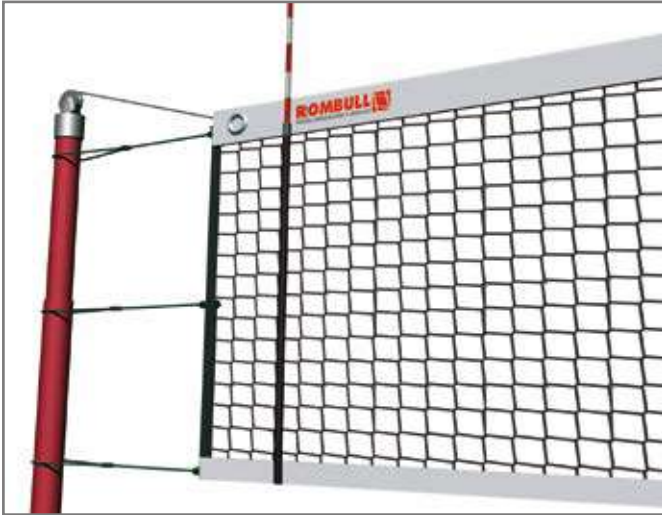

221105113966 UD. VOLEIBOL.ALTA COMPETICIÓN C-PVC SUPERIOR + INFERIOR UT. HIGH COMPETITION VOLLEYBALL C-PVC SUPERIOR + INFERIOR

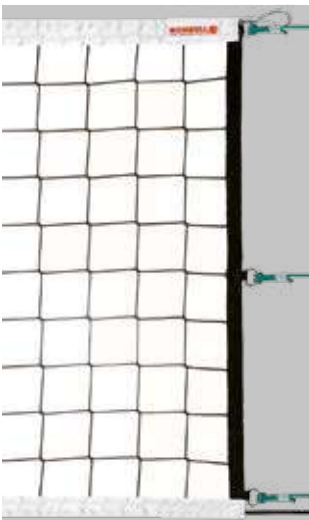

Confeccionada con hilo de polipropileno de alta tenacidad, red de 3 mm de grosor, ancho de malla de 100 mm. Banda superior de PVC blanco de 70 mm de ancho. Por el interior de esta banda pasa un cable de acero plastificado de 6 mm que ajusta la red y la mantiene tensa. Cinta de poliéster negro en los laterales, incorpora tres enganches a cada lado compuesto de tensor plástico y cuerda de tensión de 5 mm. Banda inferior de PVC blanco de 50 mm de ancho. En el interior de esta banda pasa una cuerda que ajusta la red a los postes y la mantiene tensa.

Confectioned with high tenacity polypropylene yarn 3 mm tickness, mesh size 100 mm. White PVC tape on top 70 mm wide, with steel coated cable 6 mm inside the tape. Black polyester tapes on both sides with 3 double tensioning ropes of 5 mm with plastic tensioning devices. White PVC tape at the bottom, from which a tensioning rope is located to keep the net tense.



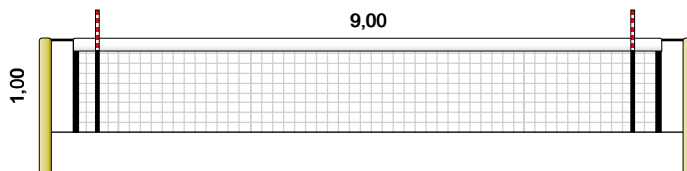

221102111666 UD.VOLEIBOL PLAYA ENTRENAMIENTO UT. BEACH VOLLEYBALL TRAINING



Red sin nudo de polipropileno alta tenacidad 2mm malla 100x100mm. Cinta parte superior, con cuerda 5mm pasada por su interior, laterales y parte inferior orillados, cuerdas de tensión en laterales superior e inferior.

Knotless net polypropylene high tenacity 2mm mesh size 100x100mm. With tape on top side, rope 5mm. Passed inside the tape, lateral and bottom sides stitched, tensioning rope on top and bottom sides.

221105111866 UD.VOLEIBOL PLAYA COMPETICIÓN UT. BEACH VOLLEYBALL COMPETITION

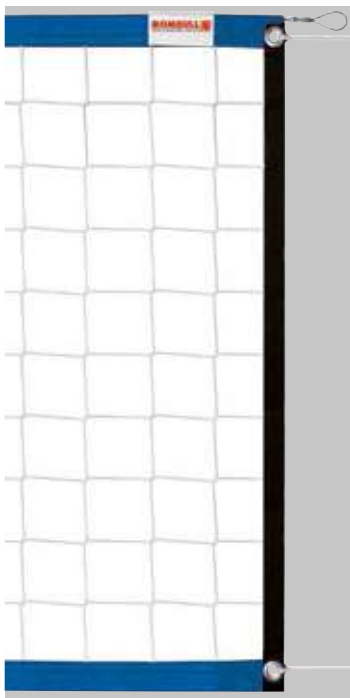

Red sin nudo de polipropileno alta tenacidad 3mm malla 100x100mm. Cinta azul de 5cm de ancho en parte superior y cable acero plastificado 3x5 pasado por su interior, cinta de poliéster negro en laterales. Cinta azul parte inferior. Cuerdas de tensión en laterales superior e inferior.

Knotless net polypropylene high tenacity 3mm mesh size 100x100mm. With blue tape 5cm. white on top side, with steel cable coated passed inside the tape, black tape on sides, blue tape 5cm. at the bottom, tensioning rope on top and bottom sides.



Baloncesto Basketball

Página 25 Tarifa. Page 25 Price List.



Código Producto Product code	Descripción Description	Color Color
---------------------------------	----------------------------	----------------

▶ Redes poliamida Polyamide nets

2170080003	JG.RED BALONCESTO PA TRENZ 4,5MM 12 ENGANCHES	44
2170090003	JG.RED BALONCESTO PA TRENZ 5MM 12 ENGANCHES	44
2170100003	JG.RED BALONCESTO PA TRENZ 6MM 12 ENGANCHES	44

Jaulas de lanzamiento Cages

Página 26 Tarifa. Page 26 Price List.



Código Producto Product code	Descripción Description	Hilo ø Yarn ø	Malla # Mesh #	Color Color
---------------------------------	----------------------------	------------------	-------------------	----------------

▶ Redes sin nudo polipropileno Polypropylene knotless netting

2011090701	M2.RED S/NUDO PPM	5MM	45X45	11 22
------------	-------------------	-----	-------	-------

DESCRIPCIÓN: Especial uso exterior, resistente a impactos directos. Protegida contra la intensa radiación solar y rayos UV. Extraordinariamente resistente a la intemperie y muy duradera. Antibacterias, anti insectos, repele la suciedad y no absorbe humedad. Máximo estándar de calidad. **USOS:** Exterior.

DESCRIPTION: Special for outdoor use, resistant to direct impacts. Protected against U.V. Extremely resistant to weathering conditions. Antibacterial, anti insects, anti dust, does not absorb humidity. Maximum standard quality. **USES:** Outdoor.

Críquet Cricket

Página 26 Tarifa. Page 26 Price List.



Código Producto Product code	Descripción Description	Hilo ø Yarn ø	Malla # Mesh #	Color Color
---------------------------------	----------------------------	------------------	-------------------	----------------

► **Redes sin nudo polipropileno** Polypropylene knotless netting

2431050801	M2.RED S/NUDO PPM	3MM	M50X50	44 66
2431070801	M2.RED S/NUDO PPM	4MM	M50X50	44 66

DESCRIPCIÓN: Redes sin nudo de polipropileno de alta tenacidad, especial para uso en exteriores, de alto rendimiento y con protección para la intensa radiación solar y rayos UV. Esta diseñada para evitar la salida de pelotas al exterior del campo de juego. **USOS:** Deportes al aire libre como el críquet o béisbol.

DESCRIPTION: High tenacity polypropylene knotless nets, special for outdoor use, highly performing. Protected against sun, humidity and UV. Prevent balls from impacting spectators or leaving the premises. **USES:** Outdoor sports such us cricket or baseball.

Béisbol Baseball

Página 26 Tarifa. Page 26 Price List.



Código Producto Product code	Descripción Description	Hilo ø Yarn ø	Malla # Mesh #	Color Color
---------------------------------	----------------------------	------------------	-------------------	----------------

► **Redes sin nudo polipropileno** Polypropylene knotless netting

2421050501	M2.RED S/NUDO PPM	3MM	M40X40	44 66
2421070501	M2.RED S/NUDO PPM	4MM	M40X40	44 66

Esquí Skiing

Página 26 Tarifa. Page 26 Price List.

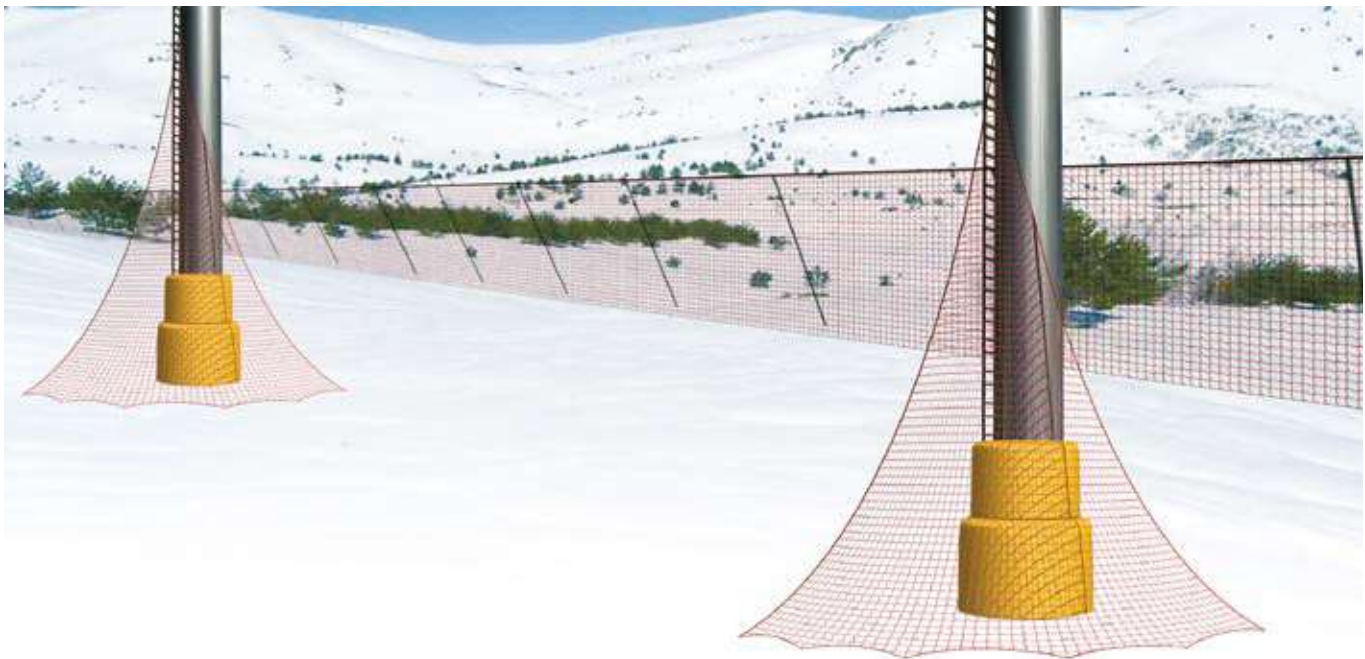

DESCRIPCIÓN: Especial uso exterior, alto rendimiento en climas fríos extremos. Protegida contra nieve, agua, humedad y rayos UV. Extraordinariamente resistente a la intemperie y muy duradera. Máximo standard de calidad. No absorbe humedad y repele la suciedad. Mantiene su tenacidad en ambientes húmedos. **USOS:** Deportes de invierno.

DESCRIPTION: Special for outdoor use, highly performing in extremely cold weather. Protected against snow, water, humidity and UV. Extremely resistant to weathering conditions. Do not absorb humidity. Maintains its tenacity in humidity. Maximum standard quality. **USES:** Winter sports.

Código Producto Product code	Descripción Description	Hilo ø Yarn ø	Malla # Mesh #	Color Color
---------------------------------	----------------------------	------------------	-------------------	----------------

► **Redes sin nudo polipropileno** Polypropylene knotless netting

2011050801	M2.RED S/NUDO PPM	3MM	M50X50	33
2011051901	M2.RED S/NUDO PPM	3MM	M70X70	33
2011051101	M2.RED S/NUDO PPM	3MM	M100X100	33
2011071901	M2.RED S/NUDO PPM	4MM	M70X70	33
2011071101	M2.RED S/NUDO PPM	4MM	M100X100	33
2011091901	M2.RED S/NUDO PPM	5MM	M70X70	33
2011091101	M2.RED S/NUDO PPM	5MM	M100X100	33



Si no encuentra la red que necesita, consúltenos, se la podemos hacer a medida. If you don't find the net you need, please contact us we can customize them for you.

Redes de cortina Curtain nets

Página 27 Tarifa. Page 27 Price List.

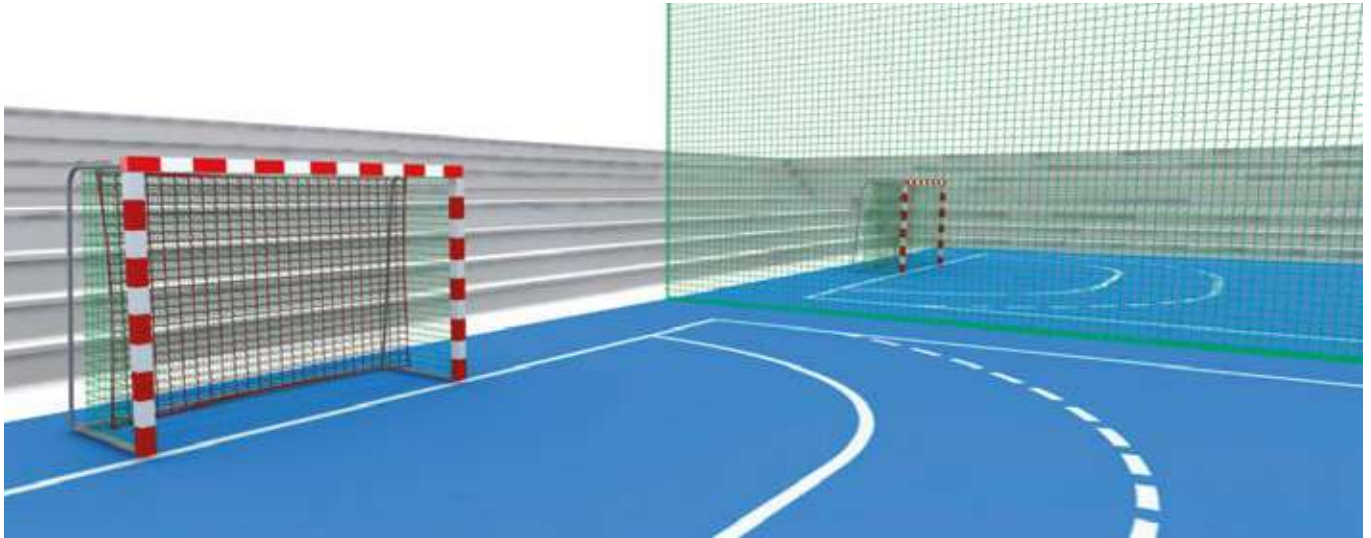

Código Producto Product code	Descripción Description	Hilo ø Yarn ø	Malla # Mesh #	Color Color
---------------------------------	----------------------------	------------------	-------------------	----------------

► **Redes de cortina sin nudo polipropileno** Curtain nets knotless polypropilene

2391050401	M2.RED CORTINA S/NUDO PPM 3MM M30X30	3MM	M30X30	11 22 33 44 55 66
2391050501	M2.RED CORTINA S/NUDO PPM 3MM M40X40	3MM	M40X40	11 44 66
2391051101	M2.RED CORTINA S/NUDO PPM 3MM M100X100	3MM	M100X100	11 22 33 44 55 66
2391051201	M2.RED CORTINA S/NUDO PPM 3MM M120X120	3MM	M120X120	11 22 33 44 55 66
2391070501	M2.RED CORTINA S/NUDO PPM 4MM M40X40	4MM	M40X40	11 44 66
2391071101	M2.RED CORTINA S/NUDO PPM 4MM M100X100	4MM	M100X100	11 22 33 44 55 66
2391071201	M2.RED CORTINA S/NUDO PPM 4MM M120X120	4MM	M120X120	11 22 33 44 55 66

Redes de techo Nets for ceiling

Página 27 Tarifa. Page 27 Price List.

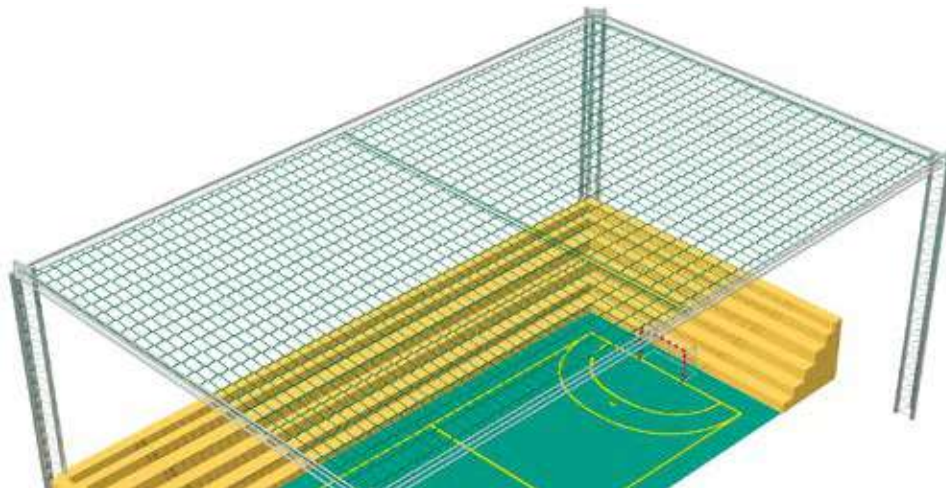

► **Redes de techo sin nudo polipropileno** Nets for ceiling knotless polypropilene

2381050401	M2.RED TECHO S/NUDO PPM 3MM M30X30	3MM	M30X30	11 22 33 44 55 66
2381050501	M2.RED TECHO S/NUDO PPM 3MM M40X40	3MM	M40X40	11 44 66
2381051101	M2.RED TECHO S/NUDO PPM 3MM M100X100	3MM	M100X100	11 22 33 44 55 66
2381051201	M2.RED TECHO S/NUDO PPM 3MM M120X120	3MM	M120X120	11 22 33 44 55 66
2381070501	M2.RED TECHO S/NUDO PPM 4MM M40X40	4MM	M40X40	11 44 66
2381071101	M2.RED TECHO S/NUDO PPM 4MM M100X100	4MM	M100X100	11 22 33 44 55 66
2381071201	M2.RED TECHO S/NUDO PPM 4MM M120X120	4MM	M120X120	11 22 33 44 55 66

Redes de protección Protection nets

Página 28 Tarifa. Page 28 Price List.

Redes de protección y seguridad para campos de juego deportivos, fútbol, balonmano, frontón, tenis, pádel, etc. evitan que los balones y pelotas impacten en los espectadores o salgan fuera del recinto, y protegen edificios cercanos al área de deporte. **USOS:** Deportes de equipo y multideporte.

DESCRIPTION: Protection and safety nets for sports fields, football, handball, racquetball, tennis, padel, etc. prevent balls and balls from impacting spectators or leaving the premises, and protecting buildings near the sports area. **USES:** Team sports and multisport.



La fabricamos a la medida que necesite, pregúntenos

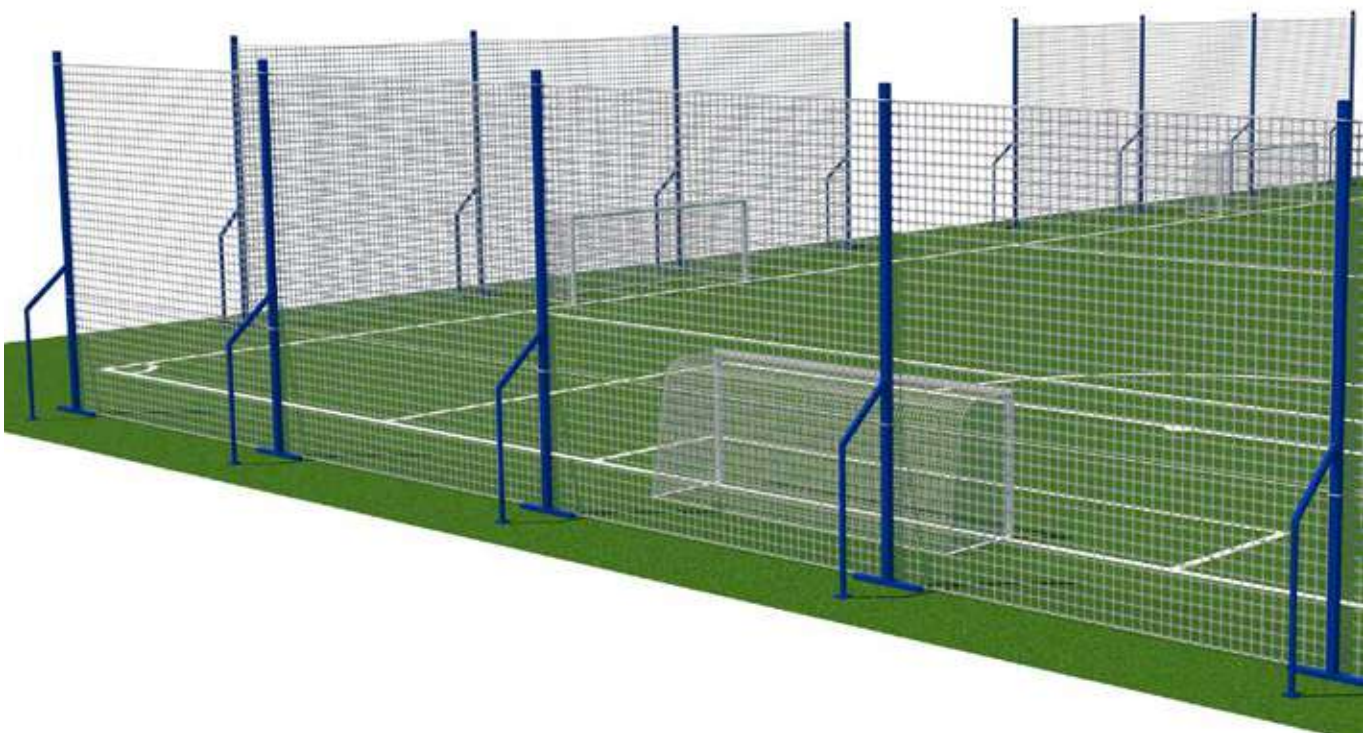

Redes de protección Protection nets

Página 28 Tarifa. Page 28 Price List.

Redes de fondo Protection nets



Red lateral Lateral protection nets

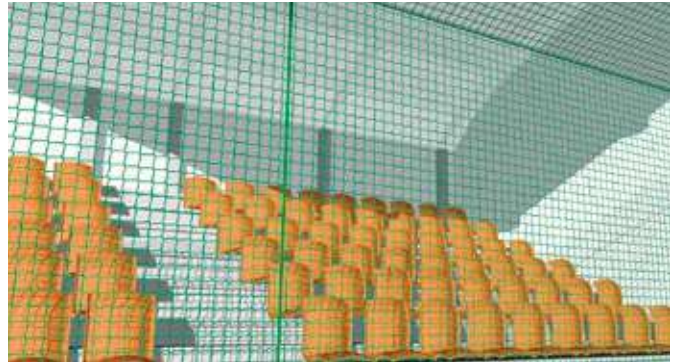

Cód. Prod. Product code	Descripción Description	Hilo ø Yarn ø	Malla # Mesh #	Color Color
----------------------------	----------------------------	------------------	-------------------	----------------

▶ Red protección sin nudo polipropileno Protection nets knotless polypropilene

2011330201	M2.RED S/NUDO PPM	1,8MM	M20X20						64
2011330401	M2.RED S/NUDO PPM	1,8MM	M30X30						64
2011330801	M2.RED S/NUDO PPM	1,8MM	M50X50						64

2011020201	M2.RED S/NUDO PPM	2MM	M20X20				44		66
2011020801	M2.RED S/NUDO PPM	2MM	M50X50				44		66

2011040301	M2.RED S/NUDO PPM	2,5MM	M25X25	11			44		66
2011040801	M2.RED S/NUDO PPM	2,5MM	M50X50	11			44		66
2011041101	M2.RED S/NUDO PPM	2,5MM	M100X100	11			44		66

2011050401	M2.RED S/NUDO PPM	3MM	M30X30	11	22	33	44	55	64	66
2011050501	M2.RED S/NUDO PPM	3MM	M40X40	11			44			66
2011050801	M2.RED S/NUDO PPM	3MM	M50X50	11	22	33	44	55	64	66
2011051101	M2.RED S/NUDO PPM	3MM	M100X100	11	22	33	44	55	64	66
2011051201	M2.RED S/NUDO PPM	3MM	M120X120	11	22	33	44	55		66

2011070501	M2.RED S/NUDO PPM	4MM	M40X40	11			44			66
2011070601	M2.RED S/NUDO PPM	4MM	M42X42							66
2011070801	M2.RED S/NUDO PPM	4MM	M50X50	11			44	55		66
2011071101	M2.RED S/NUDO PPM	4MM	M100X100	11	22	33	44	55		66
2011071201	M2.RED S/NUDO PPM	4MM	M120X120	11	22	33	44	55		66

2011090701	M2.RED S/NUDO PPM	5MM	M45X45	11	22	33			64	66
2011090901	M2.RED S/NUDO PPM	5MM	M60X60	11	22	33				
2011091101	M2.RED S/NUDO PPM	5MM	M100X100	11	22	33	44			66

▶ Red protección con nudo poliamida Knotted net from polyamide

2012060801	M2.RED C/NUDO PA	3,5MM	M50X50				44		
2012061101	M2.RED C/NUDO PA	3,5MM	M100X100				44		
2012061201	M2.RED C/NUDO PA	3,5MM	M120X120				44		
2012081101	M2.RED C/NUDO PA	4,5MM	M100X100				44		
2012081201	M2.RED C/NUDO PA	4,5MM	M120X120				44		

▶ Red protección con nudo poliéster Knotted net from polyester

2015061101	M2.RED C/NUDO PES	3,5MM	M100X100				44		
2015061201	M2.RED C/NUDO PES	3,5MM	M120X120				44		

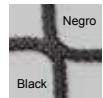
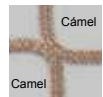

*CONSULTAR COMBINACIONES

*ASK ABOUT COMBINATIONS

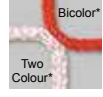

Two Colour*

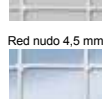

Accesorios instalación red protección Accessories for net installation

Página 29 Tarifa. Page 29 Price List.

► Accesorios de montaje Assembly accessories

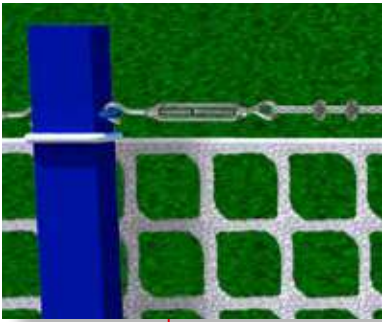

CABLE, CADENA Y ACCS.
CHAINS, WIRE ROPES & ACCS.

Puedes ver las referencias de estos artículos en la familia Cables, Cadenas y Accesorios (páginas 240, 241, 262, 263, 261 del catálogo)

You can see the references of these articles on Chains, Wire Ropes and Accessories (pages 240, 241, 262, 263, 261 of the catalog)

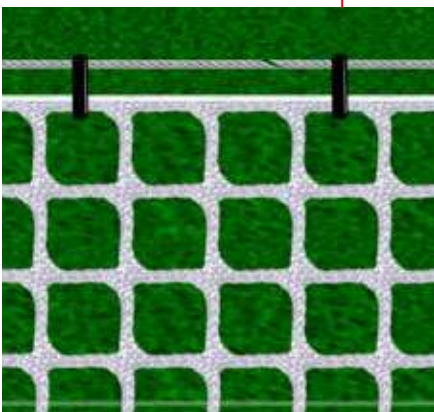

CABLE, CADENA Y ACCS.
CHAINS, WIRE ROPES & ACCS.

Puedes ver las referencias de estos artículos en la familia Cables, Cadenas y Accesorios (páginas 254, 255, 288, 289 del catálogo)

You can see the references of these articles on Chains, Wire Ropes and Accessories (pages 254, 255, 288, 289 of the catalog)



REDES DEPORTE
SPORT NETS

Golf Golf

Página 29 Tarifa. Page 29 Price List.



DESCRIPCIÓN: Redes de protección y seguridad para campos de golf, evitan que los balones y pelotas impacten en los espectadores o salgan fuera del recinto, y protegen edificios cercanos al área de deporte. Confeccionada con hilo de polipropileno de alta tenacidad sin nudo, red de 2,5 mm de grosor y un ancho de malla de 25mm. Máxima resistencia y duración a la intemperie, con tratamiento UV. **USOS:** Golf

DESCRIPTION: Protection and safety nets for golf, prevent balls from impacting spectators or leaving the premises, and protecting buildings near the sports area. Confectioned with high tenacity polypropilene knotless yarn, 2,5 mm thick and a 25 mm mesh width. Maximum resistance, UV solar treatment, Lasts longer in exterior, decreases risk of accidents. This net has been developed to avoid golf balls from trespassing the golf playing area. **USES:** Golf.

Código Producto Product code	Descripción Description	Hilo ø Yarn ø	Malla # Mesh #	Color Color
---------------------------------	----------------------------	------------------	-------------------	----------------

► Redes sin nudo polipropileno Polypropylene knotless netting

2011040301	M2.RED S/NUDO PPM	2,5MM	M25X25	11
------------	-------------------	-------	--------	----

- Especial uso exterior, alto rendimiento. Special for outdoor use, highly performing.
- Protegidas contra la intensa radiación solar y rayos UV. Protected against sun, humidity and UV.
- Extraordinariamente resistentes a la interperie y muy duraderas. Extremely resistant to all weathering conditions.
- No absorbe humedad, repele la suciedad. Sea spaces suitable, do not absorb humidity.
- Mantiene su tenacidad en ambientes húmedos. Maintains its tenacity in humidity.
- Antibacterias, antinsectos. Anti bacteria, anti insects, anti dust.
- Máximo standard de calidad. Maximum standard quality.

► Redes sin nudo poliéster Polyester knotless netting

2016040301	M2.RED S/NUDO PES	2,5MM	M25X25	91
------------	-------------------	-------	--------	----

Confeccionada con hilo de polipropileno o poliéster de alta tenacidad sin nudo, red de 2.5mm de grosor y un ancho de malla de 25mm. Máxima resistencia y duración a la intemperie, con tratamiento UV. Aporta una disminución de riesgo de accidentes.

Esta red está diseñada para evitar la salida de las pelotas al exterior del campo de juego.

Confectioned with high tenacity polypropilene or polyester knotless yarn, 2,5mm thick and a 25mm mesh width. Maximum resistance, UV solar treatment. Lasts longer in exterior, decreases risk of accidents. This net has been developed to avoid golf balls from trespassing the golf playing area.

Mantenimiento

Un buen mantenimiento evita tener que reemplazar íntegramente todo el montaje. Se debe de ir revisando frecuentemente la instalación en busca de pequeños agujeros, cables sueltos, etc.

Maitenance

A good maintenance will avoid having to change the complete setting. Regular inspections should be done searching for small holes, cuts, loosen wires, etc.

Hockey hielo y patines

Ice & roller hockey

Medidas Size 1,85 x 1,22 x 0,75 x 1,10m

Página 30 Tarifa. Page 30 Price List.

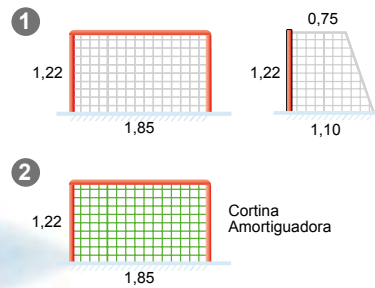
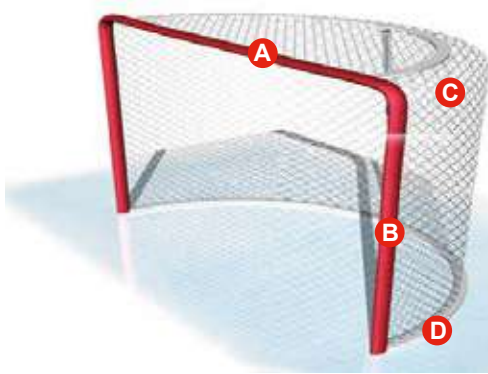

Código Producto Product code	Descripción Description	Medidas Size				Color					
		A	B	C	D						

1 ▶ Redes hockey hielo y patines polipropileno Ice and roller hockey polypropilene nets

2201050587	JG. HOCKEY PATINES PPM 3MM M40	1,85	1,22	0,75	1,10	11	22	33	44	55	66
2201070587	JG. HOCKEY PATINES PPM 4MM M40	1,85	1,22	0,75	1,10	11	22	33	44	55	66
2201090787	JG. HOCKEY PATINES PPM 5MM M45	1,85	1,22	0,75	1,10	11	22	33	44		66

2 ▶ Cortina amortiguadora hockey polipropileno Muffling curtain hockey polypropilene

2201040388	JG. CORT. AMORT. HOCKEY PAT PPM 2,5MM M25	1,85	1,22	--	--	11	22	33	44	55	66
------------	---	------	------	----	----	----	----	----	----	----	----

Hockey hierba y sala

Grass & indoor hockey

Medidas Size 3,66 x 2,14 x 0,90 x 1,20m
3,00 x 2,00 x 1,00 x 1,00m

Página 30 Tarifa. Page 30 Price List.

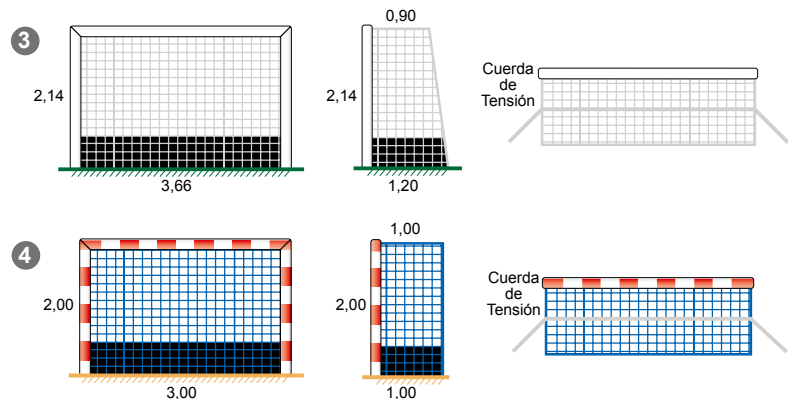
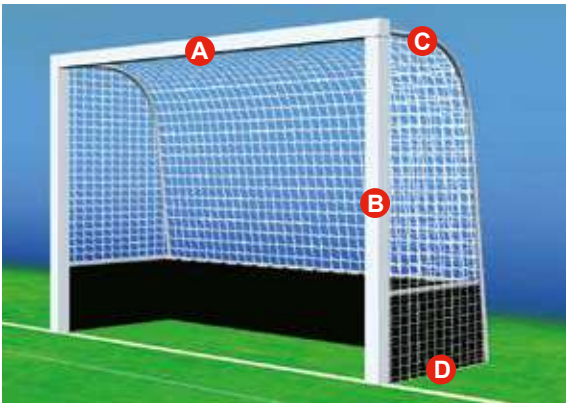

3 ▶ Redes hockey hierba polipropileno Grass hockey polypropilene nets

2191050722	JG. HOCKEY HIERBA PPM 3MM M45	3,66	2,14	0,90	1,20	11	22	33	44	55	66
2191070722	JG. HOCKEY HIERBA PPM 4MM M45	3,66	2,14	0,90	1,20	11	22	33	44	55	66

4 ▶ Redes hockey sala polipropileno Indoor hockey polypropilene nets

2261050720	JG. HOCKEY SALA PPM 3MM M45	3,00	2,00	1,00	1,00	11	22	33	44	55	66
2261070720	JG. HOCKEY SALA PPM 4MM M45	3,00	2,00	1,00	1,00	11	22	33	44	55	66



Accesorios Accessories

Página 31 Tarifa. Page 31 Price List.

Código Producto Product code	Descripción Description
---------------------------------	----------------------------

► Cuerdas trepa de cáñamo Hemp climbing rope

229000000400	UD. CUERDA DE TREPA C/NUDOS 4 METROS
229000000500	UD. CUERDA DE TREPA C/NUDOS 5 METROS
229000000600	UD. CUERDA DE TREPA C/NUDOS 6 METROS
229000000700	UD. CUERDA DE TREPA C/NUDOS 7 METROS
229000000800	UD. CUERDA DE TREPA C/NUDOS 8 METROS

229100000400	UD. CUERDA DE TREPA LISA 4 METROS
229100000500	UD. CUERDA DE TREPA LISA 5 METROS
229100000600	UD. CUERDA DE TREPA LISA 6 METROS
229100000700	UD. CUERDA DE TREPA LISA 7 METROS
229100000800	UD. CUERDA DE TREPA LISA 8 METROS

► Accesorios fútbol Football accessories

234005000144	PQ. PORTABALONES 3MM PARA 1 BALÓN / 10 UD
234005000344	PQ. PORTABALONES 3MM PARA 3 BALONES / 5 UD
234005000644	PQ. PORTABALONES 3MM PARA 6 BALONES / 5 UD
234005001044	PQ. PORTABALONES 3MM PARA 10 BALONES / 5 UD
234005002044	PQ. PORTABALONES 3MM PARA 20 BALONES / 5 UD

► Accesorios voleibol Volleyball accessories

230014000500	JG. ANTENAS VOLEIBOL DE FIBRA DE VIDRIO
230014000400	JG. ANTENAS VOLEIBOL DE FIBRA DE VIDRIO DESMONTABLES
230014000600	JG. BANDAS CORREDERAS PARA COMPETICIÓN PES
230009001200	UD. REPUESTO CABLE VOLEIBOL DE ACERO PLASTIFICADO 3X5

► Accesorios tenis Tennis accessories

229099000300	UD. CENTRO GUÍA TENIS ENGANCHE
230009001300	UD. REPUESTO CABLE TENIS DE ACERO PLASTIFICADO
2300000003044	UD. REPUESTO CINTA TENIS PES

Accesorios cordelería, página 50



Si no encuentra la red que necesita, consúltenos, se la podemos hacer a medida. If you don't find the net you need, please contact us we can customize them for you.

PARQUES DE AVENTURA

ADVENTURE PARKS



ROMBULL

Parques de aventura Adventure parks

Página 34-35 Tarifa. Page 34-35 Price List.



Redes y cordelería de última generación y alta seguridad para evitar accidentes para parques de aventura y espacios lúdicos. Garantizamos una elevada resistencia y durabilidad. Las redes están diseñadas con una doble función: permitir que los usuarios puedan trepar y sirvan de amortiguación en caso de resbalones y caídas, delimitar zonas etc. Dada la gran variedad de espacios de multiaventura, en Rombull nos adaptamos a las necesidades de cada uno y a su finalidad.

State-of-the-art Nets and ropes specially developed for adventure parks and amusement spaces to provide high security and avoid accidents. Rombull guarantees the high resistance and durability of these products. The nets are produced to fulfill a double function: allow users to climb and support them in case of falls. They can also be used to separate different spaces. As adventure parks are very diverse, Rombull is ready to adapt its solutions to the needs of each project.







01 **Adventure Knot**

- Poliestil
- Aspecto natural
- Ø 20 mm
- Nudo cada 30 cm
- Ojal guardacabo

- Polyesteel
- Natural look
- Ø 20 mm
- Knots every 30 cm
- Ends with a thimble in a loop



02 **Adventure Ring**

- Poliestil
- Aspecto natural
- Ø 16 mm
- Ojal guardacabo

- Polyesteel
- Natural look
- Ø 16 mm
- Ends with a thimble in a loop



03 **Adventure Stirrup**

- Poliestil
- Aspecto natural
- Ø 16 mm
- Ojal guardacabo
- Símil cáñamo
- Estribo acero galvanizado

- Polyesteel
- Natural look
- Ø 16 mm
- Ends with a thimble in a loop
- Similar to Hemp
- Stirrup of zinc-plated steel



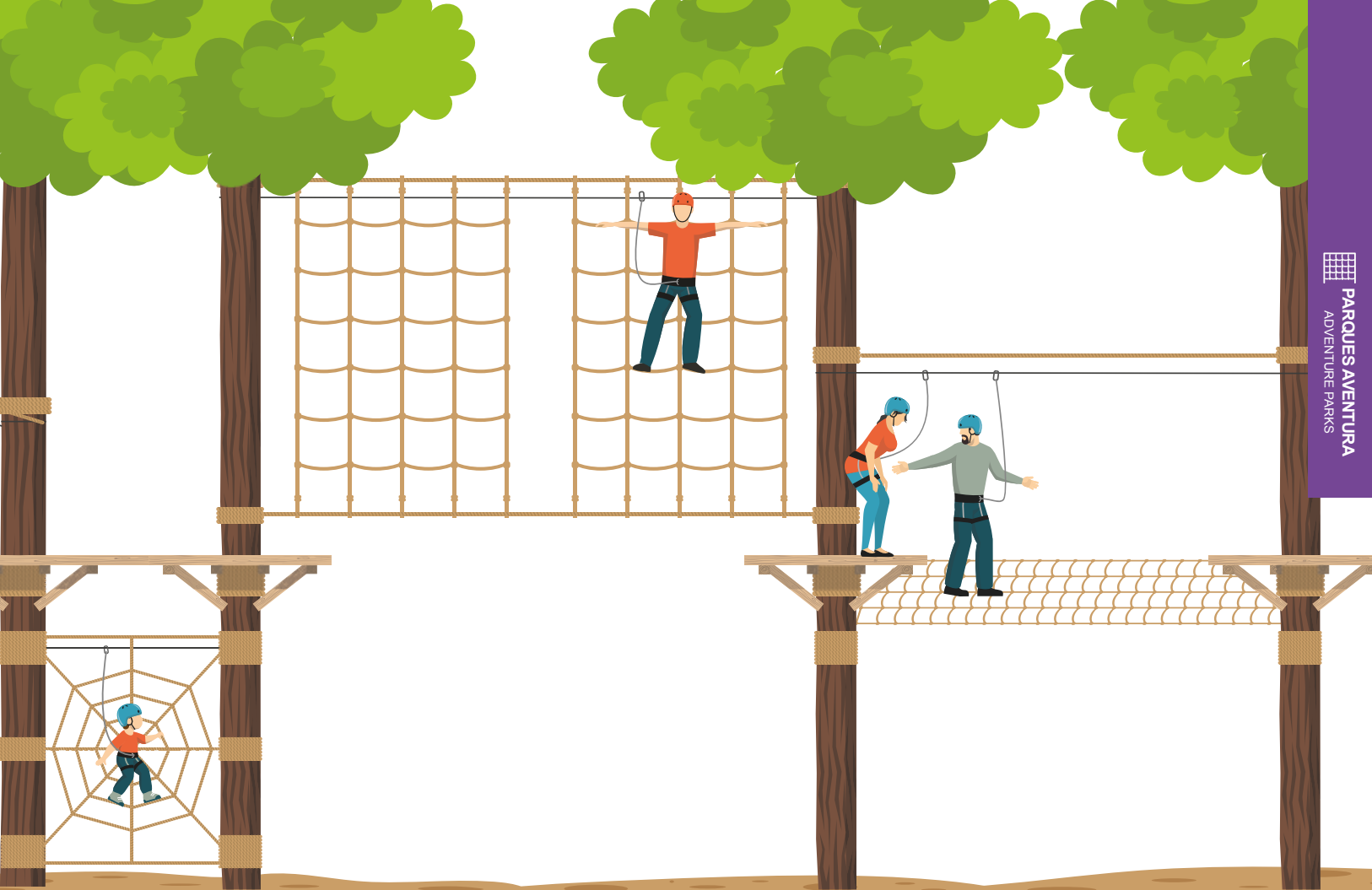

04 **Adventure Up**

- Poliestil
- Aspecto natural
- Ø 20 mm
- Anillas anudadas cada 60 cm
- Polysteel
- Natural look
- Ø 20 mm
- Rings every 60 cm



05 **Adventure Zip Line**

- Poliestil
- Aspecto natural
- Ø 16 mm
- 1 metro longitud
- Polysteel
- Natural look
- Ø 16 mm
- 1 meter length



06 **Adventure fastening**

- Poliestil
- Aspecto natural
- Ø 20 mm
- Ojal guardacabo
- Anilla en extremos
- Polysteel
- Natural look
- Ø 20 mm
- Ends with a thimble in a loop
- Two rings in the extremes



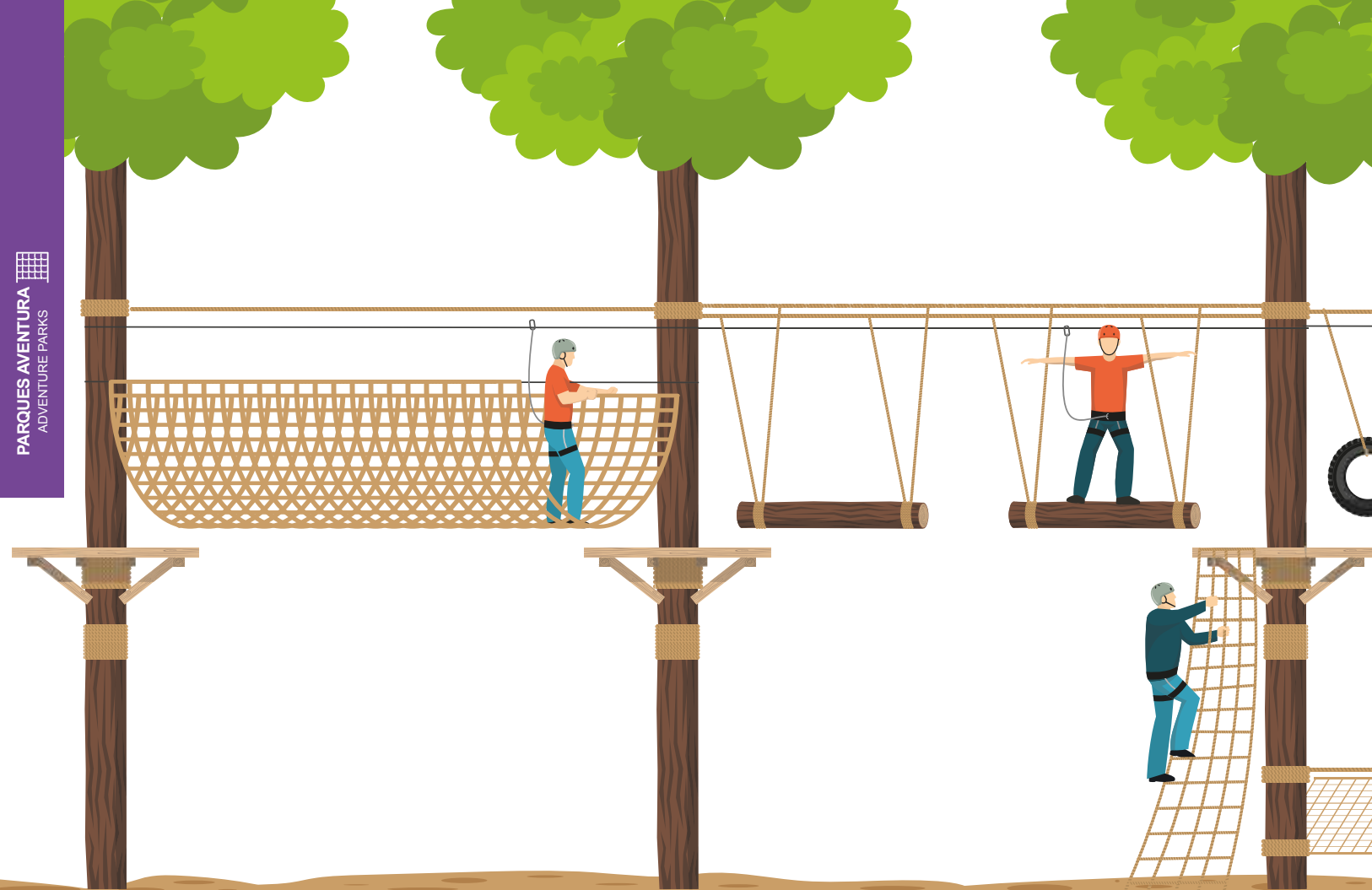

10 Adventure Climbing net

- Poliestil
- Aspecto natural
- Cuerdas 20 mm
- Mallas 250/300 mm
- Formas: cuadrado, rombo y círculo

- Polysteel
- Natural look
- 20 mm rope net
- Mesh: 250/300 mm
- Shapes: squares, diamonds and circles

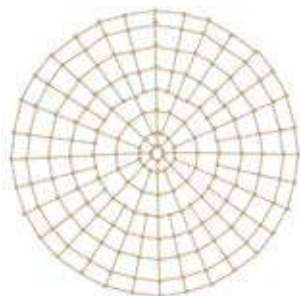

07 Adventure Flying net

- Poliestil
- Aspecto natural
- Cuerdas Ø 20 mm
- Mallas 250 mm
- Forma: cuadrada
- Anillas en ángulos

- Polysteel
- Natural look
- Ø 20 mm ropes
- 250 mm Mesh
- Shape: Squared
- Rings in each corner

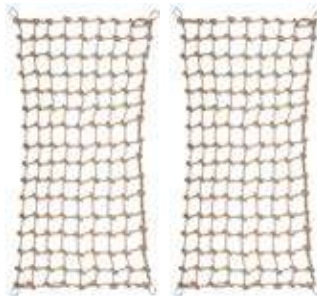

08 Adventure Walk net

- Polipropileno, sin nudo
- Beig/camel
- Trenza 5 mm
- Malla 45 mm
- Forma: cuadrada

- Polypropylene without knots
- Beige/Camel
- 5 mm net
- Mesh: 45 mm
- Shape: Squared





09 Adventure Monkey Bridges

- Polipropileno, sin nudo
- Verde/blanco/negro
- Trenza 5 mm
- Malla 45 mm
- Forma: cuadrado

- Polypropylene without knots
- Green/white/black
- 5 mm net
- Mesh: 45 mm
- Shape: Squared

11 Adventure Climb Rings

- Poliestil
- Apariencia natural
- Cuerdas Ø 20 mm
- Mallas 250/300 mm
- Formas: cuadrado, rombo y círculo

- Polyesteel
- Natural look
- 20 mm rope net
- Mesh: 250/300 mm
- Shapes: squares, diamonds and circles

12 Adventure without harness

- Poliestil
- Apariencia natural
- Cuerdas Ø 20 mm
- Mallas 50/100 mm
- Forma: cuadrada

- Polyesteel
- Natural look
- 20 mm rope net
- Mesh: 50/100 mm
- Shape: squared

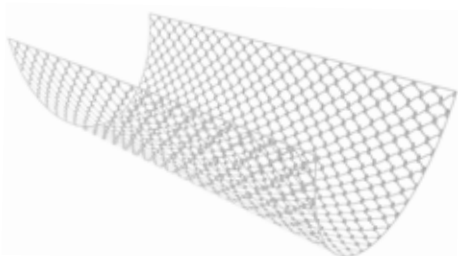

Especialmente diseñadas para parques infantiles, fabricadas de polipropileno de alta tenacidad. Muy suaves al tacto, al no tener nudos no producen rozaduras, son altamente resistentes y duraderas, mantienen su color y no se deforman. Cuentan con el máximo standard de calidad.

Specially designed for playgrounds, manufactures of polypropylene high tenacity. Extremely soft to the touch, being knotless they avoid bruises, they are extremely resistant and last longer, maintain their colour and shape. With the maximum quality standards.

▶ Redes sin nudo poliéster Polyester knotless netting

Producto Product	Descripción Description	Hilo ø Yarn ø	Malla # Mesh #	Color Color
2016040401	M2.RED S/NUDO PES	2,5mm	30X30m	Multicolor



La muestra referenciada como **RED SIN NUDO DE POLIÉSTER 2,5MM M30X30 MULTICOLOR** ha sido objeto de ensayo con resultado satisfactorio de acuerdo con la norma EN ISO 11925-2:2010; quedando clasificada según norma EN 13501-1:2007+A1:2009

The sample reference **KNOTLESS NET MADE OF POLYESTER 2,5MM M30X30 MULTICOLORED** has been tested with satisfactory result according to the standards EN ISO 11925-2: 2010; The classification according to standard EN 13501-1: 2007 + A1: 2009



▶ Redes sin nudo polipropileno Polypropylene knotless netting

Producto Product	Descripción Description	Hilo ø Yarn ø	Malla # Mesh #	Color Color
2011050401	M2.RED S/NUDO PPM	3mm	30X30m	11 22 33 44 55 66
2011050801	M2.RED S/NUDO PPM	3mm	50X50m	11 22 33 44 55 66
2011070501	M2.RED S/NUDO PPM	4mm	40X40m	11 44 66
2011090701	M2.RED S/NUDO PPM	5mm	45X45m	11 22 33 66



Mallas diseñadas especialmente para eventos de aventura al aire libre tales como paintball. Fabricadas en polietileno de alta densidad con protección solar U.V.

Nets especially designed for outdoor adventure activities, such as paintball. Made in high density polyethylene with U.V. protection.

► **M². Malla Pe Paintball Protección M².** Polyethylene paintball protection mesh

Código

Negro	PRODUCTO	511100103066
	EAN	8434035114869

► **Ud. Malla Pe Paintball Protección Ud.** Polyethylene paintball protection mesh

Código **1x100** **2x100** **3x100**

Negro	PRODUCTO	511100108066	511100110066	511100111066
	EAN	8434035114784	8434035114791	8434035064294





REDES DE INDUSTRIA

INDUSTRIAL NETS



Redes industria Industrial nets

Página 38 Tarifa. Page 38 Price List.

Rombull empresa líder en la fabricación de redes de seguridad y deportivas, responde a las necesidades de cada sector, desarrollando sus productos para proporcionar soluciones específicas que se adapten a cada uno de ellos.

Hasta hace poco nadie cubría estas necesidades, y las empresas habían de adaptarse a las características de las redes disponibles en el mercado. En Rombull nos hicimos cargo de este problema, y destinamos todos nuestros esfuerzos a la investigación para crear una amplísima variedad de redes, que desempeñen su función de una forma más específica y eficaz. Porque pensamos que son las redes las que deben adaptarse a nuestros clientes, y no al contrario.

Son muchas las empresas de toda Europa que confían plenamente en las redes Rombull y las aplican en el desempeño diario de sus actividades.

Tanto en el sector industrial como en el de la construcción, el uso de redes resulta indispensable para trabajar con seguridad y eficacia, cumplir con las normativas y, sobre todo, para evitar los posibles accidentes laborales.

Rombull leading company manufacturing safety and sports nets, responds to the needs of each sector, designing its products to provide specific solutions to suit everyone.

Until recently nobody covered these requirements and the companies in this sector had to adapt to the characteristics available in the market. In Rombull we took over this problem, spending all our efforts into research to create a wide variety of nets, performing specific and efficient function. Unlike other companies we think that the nets are those that must be adapted to the customers and not vice versa.

There are many companies in Europe are totally confident with Rombull nets, applying them in their daily activities.

In the industrial and construction sectors, the use of nets is essential to be able to work safety and efficiently, to fulfill standards and, most importantly, to prevent any possible accident at work.

Redes industriales polipropileno Polypropylene industrial nets

Cód. Prod. Product code	Descripción Description	Hilo ø Yarn ø	Malla # Mesh #	Color Color						
3011330201	M2.RED S/NUDO PPM	1,8MM	M20X20						64	
3011330401	M2.RED S/NUDO PPM	1,8MM	M30X30						64	
3011330801	M2.RED S/NUDO PPM	1,8MM	M50X50						64	
3011020201	M2.RED S/NUDO PPM	2MM	M20X20				44		66	
3011020801	M2.RED S/NUDO PPM	2MM	M50X50				44		66	
3011040301	M2.RED S/NUDO PPM	2,5MM	M25X25	11			44		66	
3011040801	M2.RED S/NUDO PPM	2,5MM	M50X50	11			44		66	
3011041101	M2.RED S/NUDO PPM	2,5MM	M100X100	11			44		66	
3011050401	M2.RED S/NUDO PPM	3MM	M30X30	11	22	33	44	55	64	66
3011050501	M2.RED S/NUDO PPM	3MM	M40X40	11			44			66
3011050801	M2.RED S/NUDO PPM	3MM	M50X50	11	22	33	44	55	64	66
3011051101	M2.RED S/NUDO PPM	3MM	M100X100	11	22	33	44	55	64	66
3011051201	M2.RED S/NUDO PPM	3MM	M120X120	11	22	33	44	55		66
3011070501	M2.RED S/NUDO PPM	4MM	M40X40	11			44			66
3011070601	M2.RED S/NUDO PPM	4MM	M42X42							66
3011070801	M2.RED S/NUDO PPM	4MM	M50X50	11			44	55		66
3011071101	M2.RED S/NUDO PPM	4MM	M100X100	11	22	33	44	55		66
3011071201	M2.RED S/NUDO PPM	4MM	M120X120	11	22	33	44	55		66
3011090701	M2.RED S/NUDO PPM	5MM	M45X45	11	22	33			64	66
3011090901	M2.RED S/NUDO PPM	5MM	M60X60	11	22	33				66
3011091101	M2.RED S/NUDO PPM	5MM	M100X100	11	22	33	44			66



Polipropileno de alta tenacidad: un material de altas prestaciones

High tenacity polypropylene: a material with high benefits

Redes para cubrir cargas Networks to cover charges

Página 38 Tarifa. Page 38 Price List.



Las redes para cubrir cargas en remolques, contenedores, camiones, de Rombull son fabricadas con Polipropileno Multifilamento de Alta tenacidad cumpliendo estrictamente con la normativa **VDI 2700 BI.3.3**.

Las redes para cubrir cargas en remolques, contenedores, camiones, de Rombull son utilizadas para cubrir cargas ligeras y sueltas como por ejemplo ramas, hierbas, papel y cartón, sobre zonas de carga abiertas, evitando así que los objetos sueltos puedan salir del recinto de carga durante el viaje. Estas redes son por lo tanto, una ayuda para asegurar la carga y evitar en gran medida los peligros para las personas, animales y otros bienes en condiciones normales de tráfico.

Estas redes para cubrir cargas son fabricadas por Rombull en diferentes grosores de hilo, así como en diferentes tamaños de mallas. Se fabrican a medida y se les puede añadir una goma elástica por el perímetro para facilitar la instalación de la red sobre el remolque, contenedor o camión.

Nets for covering loads Rombull nets for covering loads on trailers, containers, lorries, etc are manufactured with high tenacity multifilament polypropilene attending strictly To the standard **VDI 2700 BI.3.3**.

Rombull nets to cover up load son trailers, containers, lorries, etc. Are used to , cover loose and light loads like branches, grass, paper or card board on load open spaces, avoiding this way that loose objects can fall out of the load area during its transportation. Thee nets are a great help to keep the load safe and avoid any damages to itself or danger for persons, animals and any other goods in normal traffic conditions.

Rombull manufacture these nets in all different yarn thickness as in all sizes of mesh. They are also manufactured customized and an elastic rubber wire can be added through the perimeter to make its installation on trailers, containers or lorries easier.



Ecológico
Ecological



Flota
Float



Resistencia ácidos
Resistant to acids



Antibacterias
Antibacterial



Alta tenacidad
High tenacity



Baja absorción de agua
Low water absorption



Producto Product	Descripción Description	Color Color					
3101040401	M2 RED CONTENEDOR S/NUDO PPM 2,5MM M30X30	11	22	33	44	55	66
3101040801	M2 RED CONTENEDOR S/NUDO PPM 2,5MM M50X50	11	22	33	44	55	66
3101050801	M2 RED CONTENEDOR S/NUDO PPM 3MM M50X50	11	22	33	44	55	66
3101070801	M2 RED CONTENEDOR S/NUDO PPM 4MM M50X50	11	22	33	44	55	66

Acabado 1

Red para contenedor
SIN GOMA perimetral
Container net
WITHOUT RUBBER LINE



Acabado 2

Red para contenedor
CON GOMA perimetral
Container ned
WITH RUBBER LINE



Red para repisas y estanterías Nets for shelves

Página 38 Tarifa. Page 38 Price List.

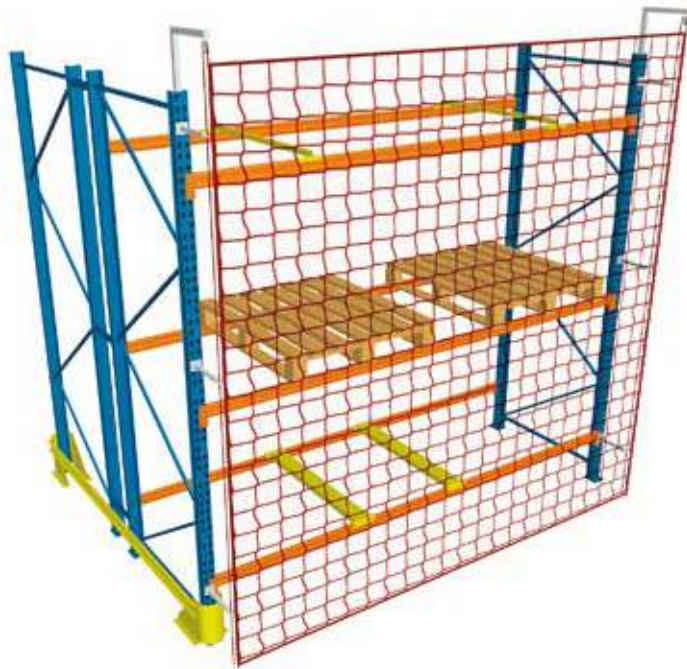

Red de protección para evitar la caída de objetos de repisas y estanterías

Net to prevent objects falling from shelves



Ecológico
Ecological



Flota
Float



Resistencia ácidos
Resistant to acids



Antibacterias
Antibacterial



Alta tenacidad
High tenacity



Baja absorción de agua
Low water absorption

Producto Product	Descripción Description	Color Color		
3111040401	M2 RED RN S/NUDO PPM 2,5MM M30X30	11		66
3111050801	M2 RED RN S/NUDO PPM 3MM M50X50	11	22	33 66
3111070801	M2 RED RN S/NUDO PPM 4MM M50X50	11		66
3111091101	M2 RED RN S/NUDO PPM 5MM M100X100	11	22	33



Red protección frontal con accesorios de extensión vertical.

Frontal protection net with accessories of vertical extension.



Red protección frontal con accesorios de extensión vertical + red frontal.

Frontal protection net with accessories of vertical extension + frontal net.



Red protección frontal con accesorios de extensión horizontal.

Frontal protection net with accessories of horizontal extension.



Red protección frontal.
Frontal protection net.



CABLE, CADENA Y ACCESORIOS CHAINS, WIRE ROPES & ACCESORIES.



En la familia Cables, Cadenas y Accesorios, le facilitamos todos los accesorios necesarios para la perfecta instalación de las redes.
We supply all the necessary accessories for the perfect installation of the nets on Chains, Wire Ropes and Accessories

Red de protección de vías de fabricación y conveyor

Protection nets for manufacturing chains and conveyors

Página 39 Tarifa. Page 39 Price List.

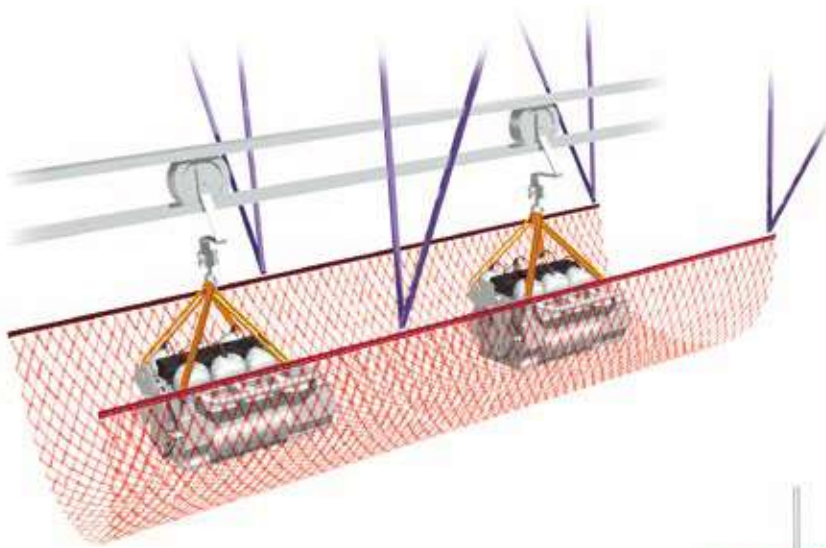

-  **Ecológico**
Ecological
-  **Flota**
Float
-  **Resistencia ácidos**
Resistant to acids
-  **Antibacterias**
Antibacterial
-  **Alta tenacidad**
High tenacity
-  **Baja absorción de agua**
Low water absorption

En toda vía de fabricación y conveyor, las posibilidades de accidentes son altas, ya que muchas veces estas líneas de producción se entrecruzan e incluso pasan sobre puestos de trabajo. Con este tipo de redes se asegura una alta retención de carga en caso de desprendimiento.

In every manufacturing chains and conveyor, the possibilities of accidents are high, since often these lines of production interweave their selves and they even pass over working areas. With these types of nets its possible to obtain a high retention load in case of detachment.

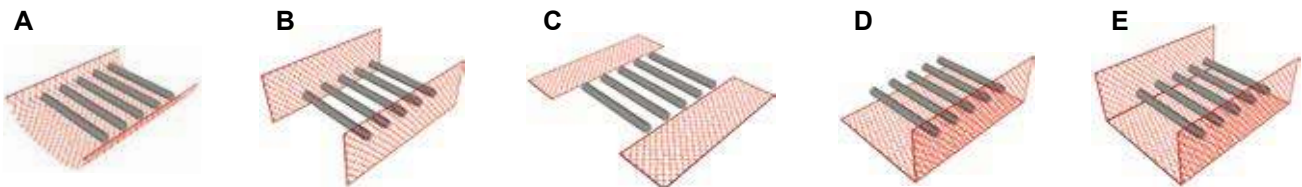
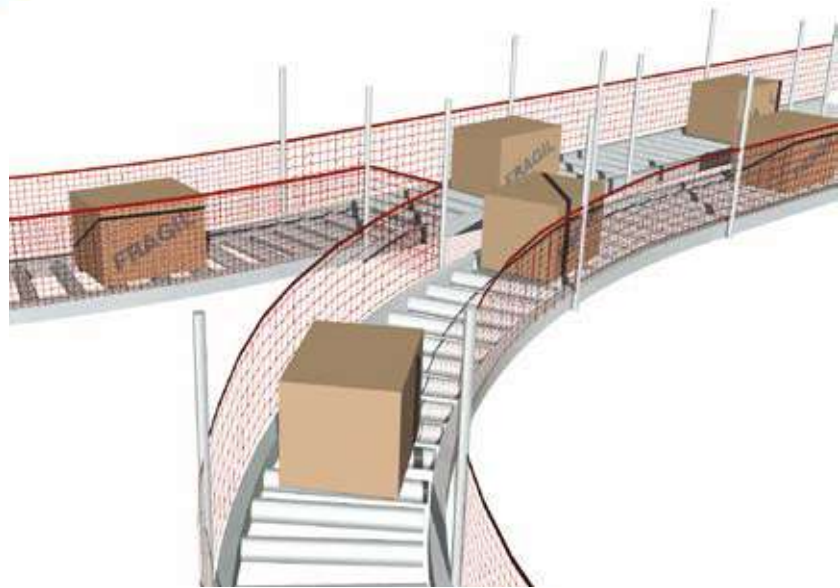

Producto Product	Descripción Description	Color Color		
3121040401	M2 RED CN S/NUDO PPM 2,5MM M30X30	11		66
3121050801	M2 RED CN S/NUDO PPM 3MM M50X50	11	22	33 66
3121070801	M2 RED CN S/NUDO PPM 4MM M50X50	11		66
3121091101	M2 RED CN S/NUDO PPM 5MM M100X100	11	22	33

CABLE, CADENA Y ACCESORIOS CHAINS, WIRE ROPES & ACCESORIES.



En la familia Cables, Cadenas y Accesorios, le facilitamos todos los accesorios necesarios para la perfecta instalación de las redes. We supply all the necessary accessories for the perfect installation of the nets on Chains, Wire Ropes and Accessories

Red para carros de transporte Nets for industrial trolleys

Página 39 Tarifa. Page 39 Price List.



Red para proteger la carga a la hora de ser trasladada en pequeños carros industriales.

Nets to prevent loads from falling when transported in small industrial trolleys.



324000003

Le facilitamos todos los accesorios necesarios para la perfecta instalación de la red.

We supply all the necessary accessories for the perfect installation of the nets.

Producto Product	Descripción Description	Color Color			
3131050401	M2 RED TH S/NUDO PPM 3MM M30X30	11	22	33	66
3131050801	M2 RED TH S/NUDO PPM 3MM M50X50	11	22	33	66

Red división de secciones Net to divide sections

Página 39 Tarifa. Page 39 Price List.



Red para la división de espacios en diferentes áreas, convirtiéndolas en zonas de uso independiente.

Nets to divide spaces, converting them in independent useful areas.

Producto Product	Descripción Description	Color Color			
3111050801	M2 RED RN S/NUDO PPM 3MM M50X50	11	22	33	66
3111051101	M2 RED RN S/NUDO PPM 3MM M100X100	11	22	33	66
3111070801	M2 RED RN S/NUDO PPM 4MM M50X50	11			66
3111071101	M2 RED RN S/NUDO PPM 4MM M100X100	11			66

Redes cierras de altillos Nets for closing upper areas

Página 39 Tarifa. Page 39 Price List.



Red para establecer un perímetro de seguridad en el cerramiento de altillos y sobrepisos.

Net to establish a safety perimeter closing upper areas such as the one seen in the picture.



Ecológico
Ecological



Flota
Float



Resistencia ácidos
Resistant to acids



Antibacterias
Antibacterial



Alta tenacidad
High tenacity



Baja absorción de agua
Low water absorption

Producto Product	Descripción Description	Color Color			
3111070801	M2 RED RN S/NUDO PPM 4MM M50X50	11			66
3111091101	M2 RED RN S/NUDO PPM 5MM M100X100	11	22	33	

Red para camiones Nets for trucks

Página 40 Tarifa. Page 40 Price List.



Red para evitar la caída de la carga desde camiones o vehículos en movimiento.

Net to prevent the load from falling, including trucks or other loading vehicles.

Producto Product	Descripción Description	Color Color			
3131070801	M2 RED TH S/NUDO PPM 4MM M50X50	11		44	66
3131090901	M2 RED TH S/NUDO PPM 5MM M60X60	11	22	33	66
3131091101	M2 RED TH S/NUDO PPM 5MM M100X100	11	22	33	44

Red separa carga Nets for separating loads

Página 40 Tarifa. Page 40 Price List.



Red de seguridad para evitar posibles desplazamientos de la carga dentro del camión.

Safety net to prevent possible movement or sliding of load inside a truck.

Producto Product	Descripción Description	Color Color			
3131070801	M2 RED TH S/NUDO PPM 4MM M50X50	11		44	66
3131090901	M2 RED TH S/NUDO PPM 5MM M60X60	11	22	33	
3131091101	M2 RED TH S/NUDO PPM 5MM M100X100	11	22	33	44

Cargas suspendidas Nets for helicopters

Página 40 Tarifa. Page 40 Price List.



Red para el transporte aéreo de objetos con helicópteros.

Net for the air transportation of objects by Helicopters.

Producto Product	Descripción Description	Color Color			
3132091101	M2 RED TH C/NUDO PA 6MM M100X100			44	
3132091107	UD RED TH C/NUDO PA 6MM M100X100 3X3			44	
3132091108	UD RED TH C/NUDO PA 6MM M100X100 5X5			44	
3132091109	UD RED TH C/NUDO PA 6MM M100X100 10X10			44	

Redes palets cargo Cargo nets for pallets

Página 40 Tarifa. Page 40 Price List.



Red para asegurar el transporte de mercancías en palets.

Net to secure the transportation in pallets.

Producto Product	Descripción Description	Color Color			
3131070801	M2 RED TH S/NUDO PPM 4MM M50X50	11		44	66
3131090901	M2 RED TH S/NUDO PPM 5MM M60X60	11	22	33	
3131091101	M2 RED TH S/NUDO PPM 5MM M100X100	11	22	33	44

Red huecos taller Nets for workshop ditches

Página 40 Tarifa. Page 40 Price List.

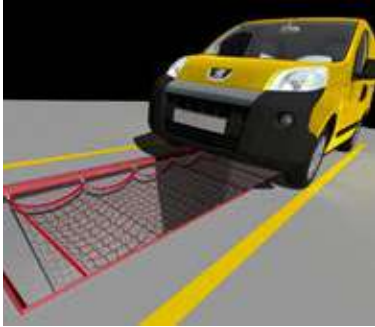

Red de seguridad para evitar accidentes en fosos de talleres de automoción.

Safety net to prevent accidents in ditches in automation workshops.

Producto Product	Descripción Description	Color Color			
3131050801	M ² RED TH S/NUDO PPM 3MM M50X50	11	22	33	66
3131070801	M ² RED TH S/NUDO PPM 4MM M50X50	11			66
3131091101	M ² RED TH S/NUDO PPM 5MM M100X100	11			

Redes cerramiento huecos Nets to cover gaps

Página 41 Tarifa. Page 41 Price List.

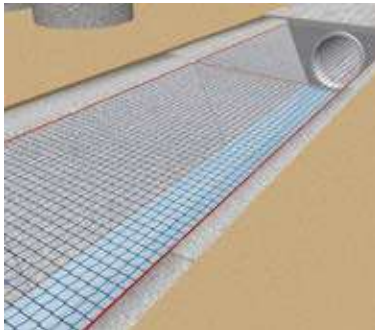

Red de seguridad para proteger de posibles accidentes en huecos de obras públicas como autopistas, canales, etc.

Safety net to prevent possible accidents in ditches of public construction sites, such as highways, channels, etc.

Producto Product	Descripción Description	Color Color			
3141050801	M2 RED PÑ S/NUDO PPM 3MM M50X50	11	22	33	66
3141070801	M2 RED PÑ S/NUDO PPM 4MM M50X50	11			66
3141091101	M2 RED PÑ S/NUDO PPM 5MM M100X100	11	22	33	

Red tendido eléctrico Power line nets

Página 41 Tarifa. Page 41 Price List.



Red de seguridad para trabajos de montaje y mantenimiento de tendidos eléctricos.

Safety nets for assembly and maintenance jobs in power lines.

Producto Product	Descripción Description	Color Color			
3161091601	M2 RED EL S/NUDO PPM 5MM M300X300				66

Redes cerramiento vertederos Closing net for landfills

Página 41 Tarifa. Page 41 Price List.



Red de cerramiento para vertederos y asentamientos de similares características.

Closing net for landfills and other purposes with similar characteristics.

Producto Product	Descripción Description	Color Color			
3261050801	M2 RED RN S/NUDO PPM 3MM M50X50	11			



Red Antipájaros - Edificios históricos

Anti birds nets - Historic buildings

Estas redes evitan la creación de nidos de aves en edificios.
Net to avoid the creation of bird nests in buildings.



Protección: Balcones e interior

Protection: Balconies and interior

Red de cerramiento. Evita la caída de objetos y garantiza la seguridad de los niños.

Closure net. Avoids objects from falling and guarantees safety for kids.

► Redes industriales polipropileno Polypropylene industrial nets

Producto Product	Descripción Description			Color Color
3011330201	M2 RED S/NUDO PPM	1,8mm	M20X20	64
3011330401	M2 RED S/NUDO PPM	1,8mm	M30X30	64
3011330801	M2 RED S/NUDO PPM	1,8mm	M50X50	64
3011050401	M2 RED S/NUDO PPM	3mm	M30X30	64
3011050801	M2 RED S/NUDO PPM	3mm	M50X50	64
3011051101	M2 RED S/NUDO PPM	3mm	M100X100	64

Colores disponibles
Colors available

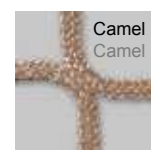
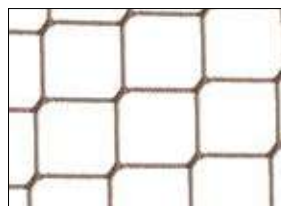

Decoración Decoration

Redes utilizadas para la decoración de espacios interiores.
Nets used as decoration for interiors.



Cerramientos Siding

Evitan la salida de objetos de un determinado recinto.
Avoids the exit of objects from any open space.

Redes flame retardant Flame retardant nets

Página 42 Tarifa. Page 42 Price List.

Las redes Rombull para industria se fabrican de acuerdo a la NORMA DIN 4102-1. Las redes Rombull Flame Retardant cumplen con los requisitos de construcción “schwerentflammbare” (no fácilmente inflamables) de acuerdo con la DIN 4102-1.

Rombull industrial Nets made according to DIN 4102-1. The Rombull Flame Retardant nets meets the requirements for “schwerentflammbare” (not easily flammable) according to DIN 4102-1.

Redes industriales polipropileno Polypropylene industrial nets

Producto Product	Descripción Description	Color Color							
3331050801	M2 RED I S/NUDO PPM 3MM M50 FR DIN4102-1 B1	11	22	33	44	55	66	77	
3331051101	M2 RED I S/NUDO PPM 3MM M100 FR DIN4102-1 B1	11	22	33	44	55	66	77	
3331070801	M2 RED I S/NUDO PPM 4MM M50 FR DIN4102-1 B1M2	11	22	33	44	55	66	77	
3331071101	M2 RED I S/NUDO PPM 4MM M100 FR DIN4102-1 B1	11	22	33	44	55	66	77	
3331090701	M2 RED I S/NUDO PPM 5MM M45 FR DIN4102-1 B1	11	22	33	44	55	66	77	
3331091101	M2 RED I S/NUDO PPM 5MM M100 FR DIN4102-1 B1	11	22	33	44	55	66	77	

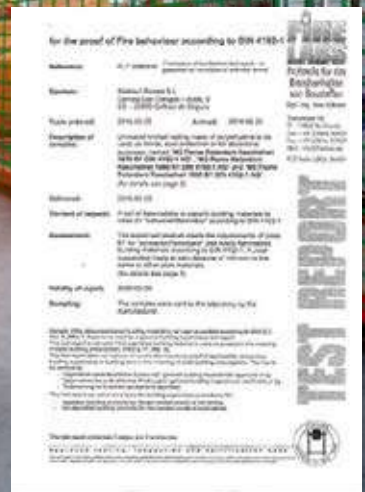
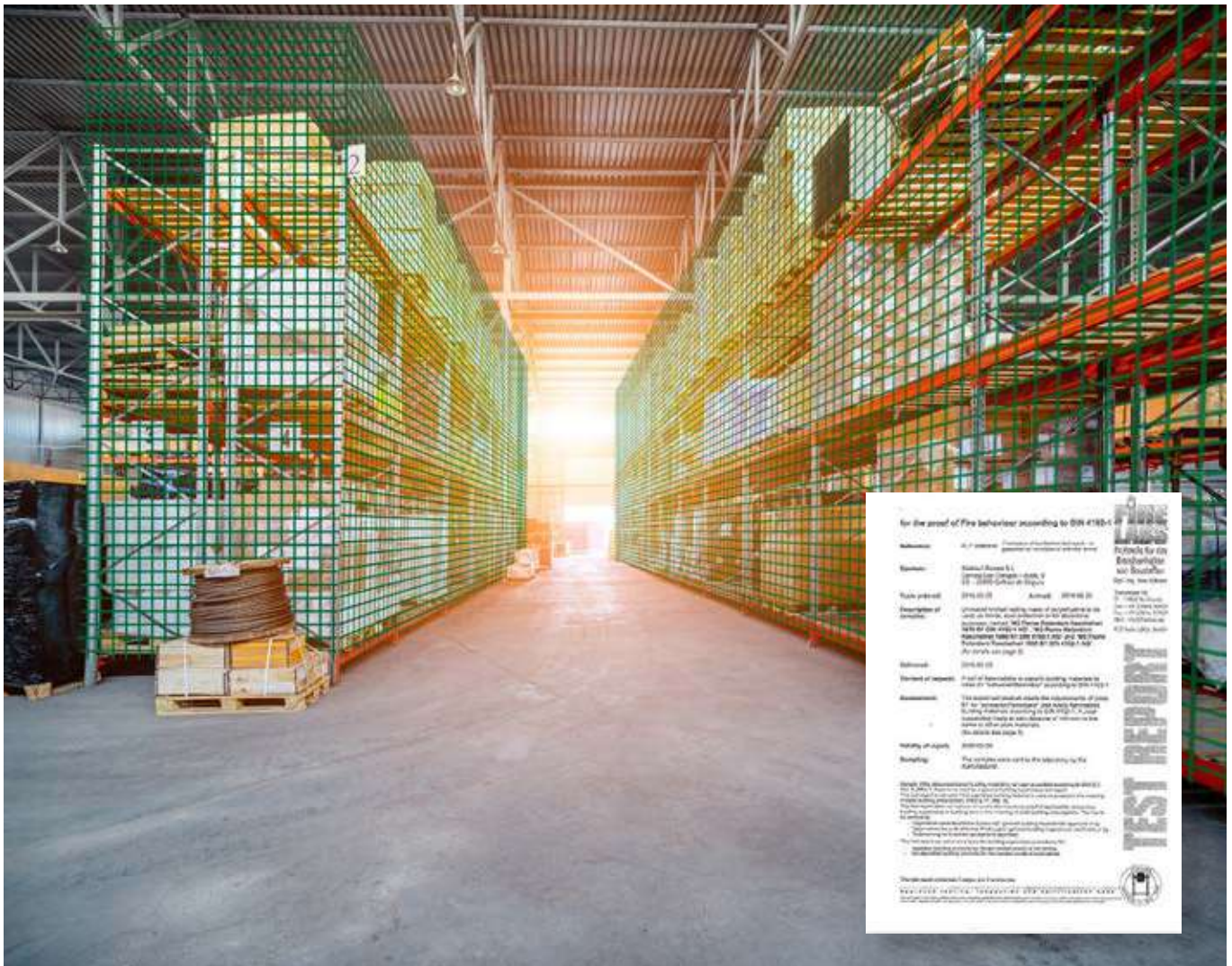

CORDELERÍA

ROPES



► Comparativa de características de las fibras Comparative characteristics of the fibers

NOTA: se utiliza nylon como base de 1.0 **NOTE:** nylon is used as the basis of 1.0

Tipo de Fibra Genérica Generic Fiber Type	Nylon	Poliéster Polyester	Polipropileno Polypropylene
Tenacidad (g/den) 1 Tenacity (g/den) 1	7.5 - 10.5	7 - 10	6.5
Elongación 2 Elongation 2	15 - 28%	12 - 18%	18 - 22%
Coefficiente de Fricción 3 Coefficient of Friction 3	.12 - .15	.12 - .15	.15 - .22
Punto de Fusión Melting point	425° - 490° F	480° - 500° F	330° F
Temperatura Crítica 4 Critical Temperature 4	325° F	350° F	250° F
Gravedad Específica Specific Gravity	1.14	1.38	.91

- Tenacidad:** es la medida de resistencia a la rotura de las fibras.
- Elongación:** se refiere al porcentaje de elongación de las fibras hasta la rotura.
- Coefficiente de Fricción:** basado en la tendencia a la rozadura.
- Temperatura Crítica:** se refiere al punto en el que la degradación está causada únicamente por la temperatura.

- Tenacity** is the measurement of the resistance of the fibers to breaking.
- Elongation** refers to the percentage of elongation of the fibers at break.
- Coefficient of friction:** is based on reluctance to slip or slide.
- Critical temperature:** it refers to the point at which degradation is caused by temperature it self.

► Tipos de cuerda según su construcción Types of rope by construction

TRENZADO CON ALMA BRAIDED WITH CORE

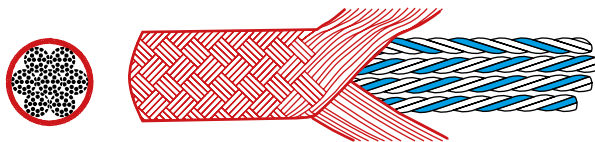

TRENZADO CON ALMA DOBLE BRAIDED WITH DOUBLE CORE

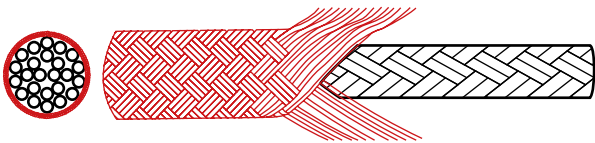

CABLEADO 3 CABOS 3 STRAND CABLED



CABLEADO 4 CABOS 4 STRAND CABLED

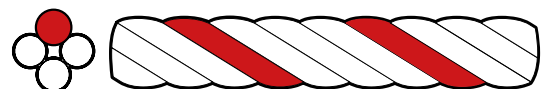

TRENZADO LISO SMOOTH BRAIDED

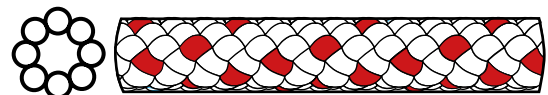

► Descripción de la etiqueta Label description

USOS / APLICACIONES
TENDEDEROS, CAMPING, CERCADOS, EFECTOS NAVALES, PERSIANAS, BRICOLAJE.

Md. Cuerda Fantasia PES plastificada
5mm 25mtl Amarillo FI

PES Plastif
5 mm
25 mtl
MADE IN SPAIN
C. ROTURA: 179 KG
Lote: 2865

403309002250

8434035 028463

► Terminología Terminology

Trenzado: Proceso que consiste en entrelazar los materiales de la cuerda de manera helicoidal, de modo que el número de filamentos o de hilos que forman hélices en una dirección se equilibra por un número igual de filamentos o de hilos que forman hélices en la dirección opuesta.

Braid: The process to produce rope or textile structure formed by a braiding process in "V" form, The interwining of strands in a briding process to produce a rope structure.

Cableado (cuerda retorcida): Proceso que consiste en fabricar una cuerda de cabos retorciendo o disponiendo cabos conjuntamente para formar una construcción estable que no se desenrede.

Twisted: The number of turns about the axis applied to a fiber, yarn, strand or rope over a given length to combine the individual elements into a larger and stronger structure.

Cordón: Producto retorcido o trenzado, de diámetro habitualmente inferior a 4mm.

Cord: A small braided item of cordage, usually less than 4mm of diameter.

Cuerda: Producto independiente de su diámetro, fabricado por torsión o trenzado de materias fibrosas, para obtener una cuerda acabada, una línea o un cordón.

Rope: A rope is a length of fibres, twisted or braided together to improve strength for pulling and connecting.

Alma: Parte central integral de una cuerda, de un cabo o de un cordón, que no está combinada, por torsión o por trenzado, con cualquier otro componente de esta cuerda, cabo o cordón.

Core: A textile product (yarn, strand, small diameter rope etc.) placed in the center of a rope and used as a support for the strands around it.

Cuerda con alma: Cuerda retorcida o trenzada utilizada como elemento de una sub-cuerda de estructura paralela.

Rope with core: Twisted or braided rope used as an element of subrope of a parallel structure.

Cuerda de trenzado doble: Cuerda en la que un determinado número de cabos están trenzados para formar un alma, alrededor de la cual se trenzan otros cabos para formar una funda.

Double braided rope: Two ropes in one, a braided core is over-braided with a cover braid, hence the terms braid on braid and 2 in 1 braid. / Exceptionally strong rope construction of a core braid containing within an outer braided jacket.







Cuerda de almas paralelas: Cuerda en la que el alma que aguanta la fuerza está formada por un número de elementos, sean hilos o sub-cuerdas, dispuestos en paralelo y mantenidos conjuntamente por una cobertura trenzada o extruída que no contribuye, o sólo lo hace ligeramente, a la resistencia de la cuerda.

Parallel core rope: Specialized construction consisting of parallel fiber core wrapped with a double layer and covered with a braided jacket.

Cuerda retorcida: Cuerda en la que tres o más cabos están retorcidos alrededor del eje central.

Twisted rope: The number of turns about the axis applied to a fiber, yarn, strand or rope over a given length to combine the individual elements into a larger and stronger structure.

► Pictogramas Pictograms

 Alta tenacidad High tenacity	 Flota Float	 Resistente a la fricción Resistant to friction	 Poca elongación Low elongation	 Cableada Twisted
 Baja absorción de humedad Low moisture absorption	 No conductor electricidad No conductor of electricity	 Producto ecológico Organic product	 Sin cortes No cuts	
 No absorbe suciedad Does not absorb dirt	 Resistentes a ácidos Resistant to acids	 Doble trenzado Double stranded	 Intemperie Outdoor	



Ovillo Ball



Madeja Hank



Bobina Spool



Rollo Roll



Carrete Reel



Balona Reel

Nudos Knots

Los nudos permiten unir distintos cabos, fijar elementos, amarrar y en definitiva, hacer útiles las cuerdas. Sin ellos todas estas maniobras no se podrían realizar. Hay muchos tipos de nudos y son muy distintas sus aplicaciones, sus propiedades y la dificultad de realización. Los nudos tienen sus limitaciones, siendo la más importante, el debilitamiento de la propia cuerda, producida por la configuración del nudo. Esta pérdida de fuerza puede ir entre un 20% y hasta un 85% en función de sus características. Esto es debido a que la cuerda ofrece la máxima resistencia cuando esta en línea recta.

Knots allow us to join different strands, fix elements, tie and make ropes useful. Without them all this handling could not be realized. There are many types of knots and many different uses, their characteristics and difficulty in making them. The knots have their own limitations being the most important the loss of strength of the rope, produced by the knots configuration. This loss of strength can go from between 20% and up to 85% in according to of its characteristics. This is because the rope offers the maximum strength when in a straight line.

Terminología Terminology

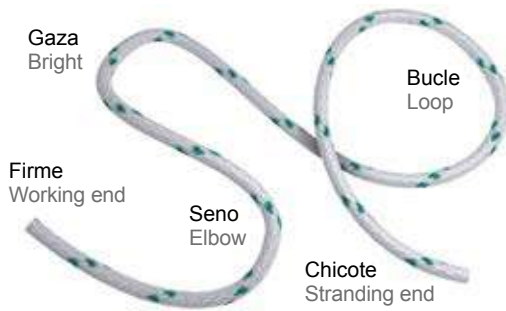

- **GAZA:** Bucle sin cerrar.
- **BRIGHT:** Any curved section or loop between the ends of a rope.
- **BUCLE:** Gaza cerrada sobre si misma.
- **LOOP:** A full circle formed by passing the working end over itself.
- **CHICOTE:** Extremo corto de la cuerda que se introduce para realizar el nudo.
- **STRANDING END:** The end of the rope not involved in making the knot.
- **SENO:** Hablamos de seno cuando introducimos una gaza o bucle de la cuerda.
- **ELBOW:** Two crossing points created an extra twist in a loop.
- **FIRME:** Extremo largo de la cuerda.
- **WORKING END:** The active end of a line used in making the knot.

As de Guía Bowline

Sin duda el nudo más importante para la marinería por sus múltiples ventajas. No se afloja, no se escurre, se deshace sin mucho esfuerzo, lo que le caracteriza para multitud de funciones, como atar un objeto realizar aparejos móviles, etc.

With no doubt the most important for the seamanship's due to its many advantages. It doesn't get loose, doesn't slip, easily undone without much effort, it can be distinguished for its multiple functions such as tying objects to perform mobile gear, etc.

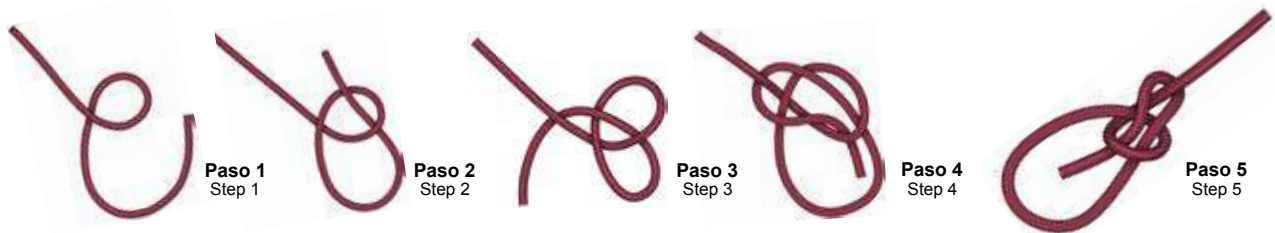

Con argolla Around a ring

Para realizarlo en torno a una argolla se puede seguir esta alternativa:
To perform it around a ring, you can follow these steps:



Con una mano With one hand

O incluso se puede realizar con una sola mano y algo de destreza, resolviendo situaciones en las que debemos actuar sobre distintos elementos simultáneamente.

It can even be made with one hand and some skill, resolving situations where we have to act at the same time on different elements.



Estrobo Splice

Los empalmes con estrobo son formas ordenadas y fuertes para unir la cuerda sin nudos. Se unen dos cuerdas por sus extremos o también se hace sobre la misma cuerda. Estrobo con una cuerda de tres cabos se han realizado durante siglos. Es la unión más fiable que se puede hacer para unir dos cuerdas. Estas uniones no representan pérdida de fuerza en la cuerda, al contrario que los nudos. Por este motivo siempre son recomendables si se dispone de la destreza para hacerlas.

The joining with splices are ordered and strong forms, to join ropes without knots. Two ropes are joined together or it can also be done on the same rope. For centuries the splices with a three strand rope have been made; it's the trustiest way to join two ropes together. Unlike the knots, the union with splices do not represent any loss of strength on the rope. For this reason we always recommend it if you have the skill to do it.



► Ballestrinque Clove hitch

Es el nudo más utilizado durante una atracada. Se puede finalizar con una vuelta mordida que nos permitirá deshacerlo de forma inmediata al tirar del chicote.

It's the most used knot for docking a boat. It can be ended with a baited turn which will allow us to undo it immediately by pulling from the stranding end.

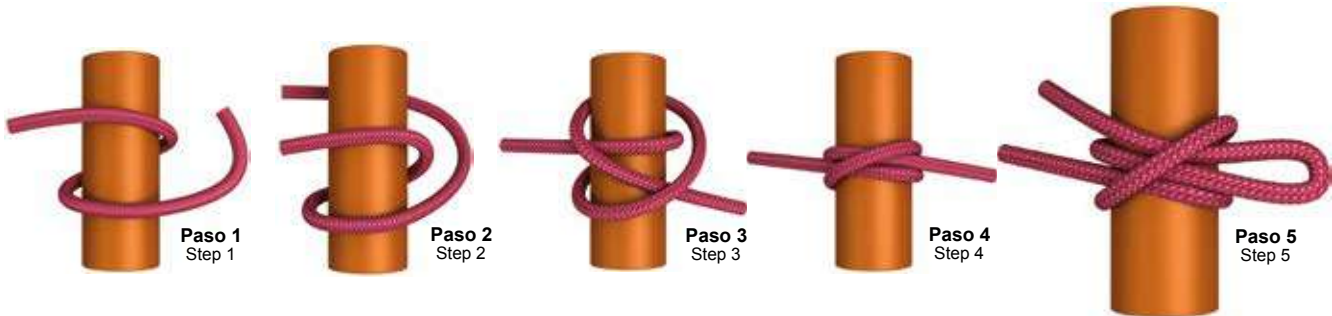

► Nudo del 8 o lazada Eight or lacing

Es difícil deshacer bajo carga, pero es muy sencillo de hacer y muy seguro con cualquier tipo y calidad de cabo. De un solo vistazo se puede saber si está bien hecho, dada su peculiar y bella forma. Además de en náutica se utiliza mucho en montaña por la confianza que inspira.

It's difficult to undo under pressure, but very easy to make and very safe with any quality rope. We can see if the knot is well done with only a quick look at it, you will recognize it for its peculiar and beautiful shape. Apart from nautical, it's very much used in mountain for the confidence that it inspires.

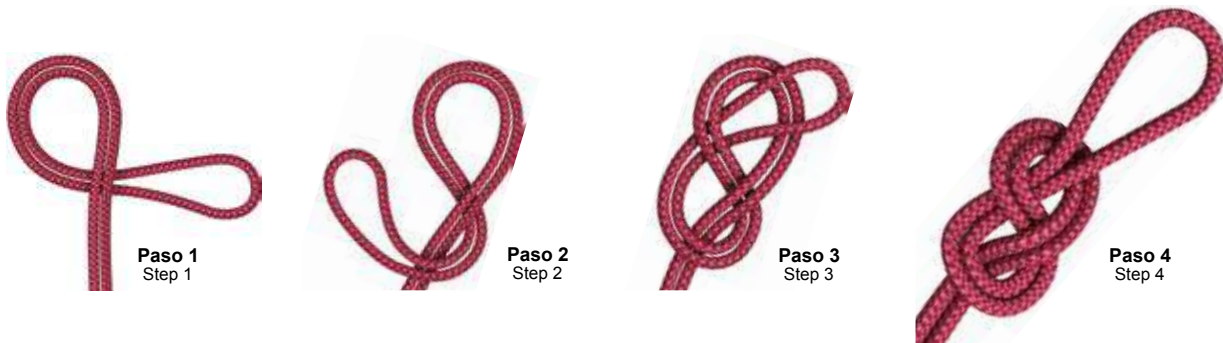

► Nudo de Pescador Fisherman Knot

Ideal para unir 2 cordeles o cabos de pequeña sección. Se trata de un nudo muy fuerte formado por la unión de dos sencillos lazos. También es conocido como Nudo Inglés.

This type of knot is ideal to join two ropes or strands of small section together. It's a very strong knot, formed by joining two simple laces. It is also known as English knot.



► Elegir una cuerda Choose a rope

Existen múltiples tipos de cuerda para distintos trabajos o aplicaciones. Consulte siempre con el fabricante que le recomendará el producto concreto que más se adecúe a sus necesidades. En Rombull Ronets, S.L. disponemos de personal cualificado para este fin. Cuando el riesgo para las personas o el daño a la propiedad esté presente, se han de tener en cuenta diversos factores. Asegúrese de que la cuerda es la adecuada para el trabajo que va a realizar, que su tamaño y grosor es el correcto. Observe las especificaciones disponibles en el etiquetado.

There are many types of ropes for many different purposes. Consult always the manager, who will recommend the best specific products to cover properly your needs. Rombull Ronets counts with qualified professional staff to make this possible. When there is any risk or danger, for either people nor property, many facts have to be known. Make sure that the used rope is the proper specific one for the work to be done, that its size and width is the correct, check out the specifications on its label.

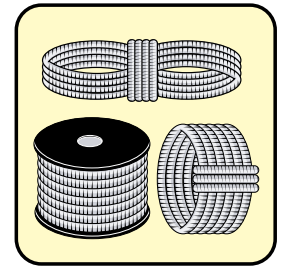

► Resistencia de las cuerdas Resistance ropes

Las diferentes materias primas y las diversas configuraciones de cuerdas hacen que no todas resistan la mismo a igual grosor, la cordelería fabricada por Rombull dispone de un etiquetado con información sobre la carga de rotura que soporta la cuerda. Esta carga de rotura se obtiene en el laboratorio, en unas condiciones concretas y con el dinamómetro calibrado al llegar al punto de fractura de la cuerda. Para el uso de las cuerdas se debe aplicar un factor de seguridad entre 5 y 12 dependiendo de las aplicaciones o circunstancias del uso. Tengamos en cuenta que los nudos que realicemos a la cuerda la debilitan y bajan su carga de rotura hasta un 65%. Se deben emplear rangos altos en factor de seguridad cuando:

- La carga no se conoce con precisión.
- Los trabajadores no están debidamente formados o carecen de experiencia.
- La inspección es poco frecuente.
- La abrasión, el corte y la suciedad están presentes.
- Las cargas de impacto o dinámicas pueden ser probables.
- Las altas temperaturas o los agentes químicos están presentes.
- Las tensiones de las cuerdas se van a mantener indefinidamente.
- Se corre riesgo de accidente con consecuencia para las personas o sobre el valor de los materiales.
- Se utilizan poleas con curvas muy cerradas.
- Se hacen nudos que afectan a la resistencia de las cuerdas.

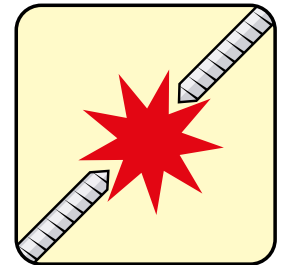

Otro aspecto importante es cuando va a soportar impactos dinámicos por cargas suspendidas, esto puede aumentar el valor de la carga en dos o tres, incluso más veces. Siempre que haya riesgo para las personas, se debe extremar la precaución en el uso de las cuerdas y aplicar un factor de seguridad mayor.

The different prime materials and many rope configurations make, not every rope have the same resistance. All cordage manufactured in Rombull Ronets counts with a label with information about the breaking load that the rope will support. We obtain the breaking load of a product with a calibrated dynamometer, in the laboratory, under specific conditions when the rope reaches the point of fracture. For the use of ropes a safety grade in between 5 and 12 must be applied, depending on its applications and use conditions. We also have to know that knots will weaken the rope and decrease its strength by as much as 65%. Big ranges in safety facts have to be used when:

- Load is not precisely known.
- Workers have no experience or are not properly trained.
- Inspections are not frequent.
- There is abrasion, cuts or dirtiness.
- Impact or dynamic loads are probable.
- High temperatures or chemical agents are present.
- Tension in the ropes is going to be held indefinitely
- There is an accident risk, with negative consequences for persons or the value of materials.
- Pullies with very closed curves are going to be used.
- Knots that can affect the rope resistance are done.

Another aspect that has to be taken into account is when it's going to support dynamic impacts from suspended loads, this fact can increase the value of the load by two, three or even sometimes more. Whenever there is a risk for people, we must use ropes under extreme safety precautions.

► Extracción de las cuerdas Rope rolls and bobines extraction

Retire la cuerda correctamente desde rollos y carretes para evitar que se doblen, o la producción de cocas. Si la cuerda está en un rollo se debe retirar desde la parte interior, si va enrollada la cuerda en un carrete se debe tirar de la cuerda haciendo girar el carrete colocando un eje en su interior, esto evita torceduras de la cuerda o hockles.

Remove correctly the rope from spools and rolls to make sure it comes out correctly and it doesn't bend or twist. If the rope is in a roll it should be removed from the interior, if it comes from a spool it should be retired by placing and axe in the interior and pulling from the rope making it turn. This method will avoid its twisting or bending.



► Abrasión Abrasion

Proteja las cuerdas de la abrasión durante su uso, compruebe que las poleas o material rodante que entra en contacto con la cuerda esté libre de aristas cortantes, óxidos y gire libremente. Las cuerdas se verán dañadas si entran en contacto con superficies ásperas o con bordes afilados. Las cuerdas deben ser del tamaño adecuado para que se acoplen bien al diámetro de la polea, para que no produzcan roces excesivos o fricción, que puedan dañar las cuerdas.

Protect ropes during its use check out pulleys or any turning or rotational material that comes in contact with the ropes, make sure they are free of cutting edges, oxides and that they can rotate properly. Ropes will be seriously damaged if they come in contact with rough surfaces or cutting edges. Pulleys must have the proper size so that it can adjust to the ropes diameter perfectly, in order no to make twists or friction, that can damage the rope.

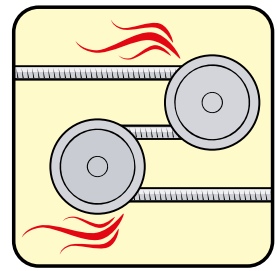

► Almacenamiento y cuidado de la cuerda Storage and care of the rope

Con la finalidad de alargar la vida útil de la cordelería y poder garantizar las prestaciones de la cuerda se han de seguir las indicaciones del fabricante. Todas las cuerdas deben ser almacenadas en lugares limpios y secos, fuera de la luz directa del sol y alejados de temperaturas extremas. Colocándola en estantes separados del suelo, que permitan su ventilación. Nunca debe estar sobre suelos de cemento o tierra, ni cerca de ácidos o alcalinos. La exposición a la luz solar directa debilita las fibras sintéticas. La humedad produce mohos que perjudican las fibras naturales como Sisal y Cáñamo. Si en su uso la cuerda se moja o ensucia se debe proceder a su limpieza y secado previo a su almacenamiento. La limpieza de las cuerdas de fibra sintética se debe realizar con agua templada y jabón neutro nunca con productos químicos. La decoloración y deshilado de la superficie indican el deterioro que ha sufrido una cuerda por su uso. En caso de duda puede consultar a nuestro departamento técnico que le asesora sobre ello.

In order to make longer the useful life or cordage and be able to keep the guarantees of its characteristics, indications from the manufacturer must be followed. Ropes must be kept in a clean and dry place, out of direct sunlight projection and away from extreme conditions. Placed separated from the floor to permit its ventilation. Never store in dirt floor such as concret or ground, neither close to acid or alkalis. Direct exposure to sunlight will weakness synthetic fibers. Humidity produces fungus that weakens natural fibers such as Sisal or Hemp. If ropes get wet or dirty during their use they must be cleaned up and dry before their storage. Synthetic fiber ropes must be done with medium temperature water and neutral soap. Always avoid using chemical products. Discoloration and fraying of the surface indicates us that the product is deteriorated because of its use. You can contact our technical department, who will help you in case of any doubt.



► Advertencias Warnings

Toda cuerda sintética bajo carga retrocederá, si un accesorio como una cadena, gancho, cornamusa, perno o bola de enganche fallase. Cuando las cuerdas están en tensión hay que tomar la precaución de alejarse para prevenir accidentes en caso de producirse estos fallos.

Every synthetic rope under load will retrocede, if an accessory such as a chain, hook, bolt or hooking ball would fail. When ropes are in tension we must take precautions and keep away from them to avoid accidents in case of suffering these failures.



► Desechar una cuerda Trow out a rope

Una cuerda se debe desechar cuando:

- Este deteriorada, presente cortes o deshilachado.
- Su envejecimiento sea evidente.
- Presente rigideces.
- Tenga deformaciones permanentes en su estructura.
- Presente quemaduras.
- Ha entrado en contacto con productos químicos que provoquen su deterioró.
- La cuerda a trabajado ha temperaturas altas superiores a 60° de forma prolongada.
- Ha soportado cargas dinámicas repetidas próximas a su carga de rotura.

Ropes must be thrown out when:

- It's deteriorated, has cuts or its frayed.
- It's clearly old.
- Shows stiffness.
- Has permanent deformities in its structure.
- It shows burns.
- It has been in contact with chemical products which damage it.
- Ropes have been used in high temperatures over 60°C, in an extended period of time.
- It has supported, repeatedly, dynamic loads that come close to its breaking load.



Hilo replanteo polipropileno trenzado 1,5 a 2,3 mm

Polypropylene braided thread 1,5 to 2,3 mm

Página 45 Tarifa. Page 45 Price List.

- **COMPOSICIÓN:** Hilo trenzado, de polipropileno multifilamento de alta tenacidad, protección solar.
- **CARACTERÍSTICAS:** Fibra suave y flexible, muy ligera, posee flotabilidad con gran resistencia a la tracción, buena anudabilidad, resistente a la mayoría de los ácidos.
- **APLICACIONES:** Albañilería, jardinería, horticultura, bricolaje, manualidades, paquetería, deporte, etc.

- **COMPOSITION:** High tenacity braided polypropylene multifilament yarns with UV protection.
- **FEATURES:** Soft and flexible fiber, very light, buoyant with great tensile strength, resistance to most chemicals, and excellent knotted.
- **APPLICATIONS:** Masonry, gardening, horticulture, DIY, crafts, packaging, sports, etc.

▶ Ud. Hilo replanteo 8841 PP trez.



Grosor / Thickness **1,5 mm** Resistencia / Breaking load **33 kg** Carga trabajo / Work load **9,9 kg**

1,5 mm



Bobina

	Código	50 m - 68 g	100 m - 135 g	200 m - 210 g	500 m - 490 g
Verde	PRODUCTO	421301001111	421301000911	421301001011	421301001511
	EAN	8434035032828	8434035032729	8434035032774	8434035032873
Azul	PRODUCTO	421301001122	421301000922	421301001022	421301001522
	EAN	8434035032835	8434035032736	8434035032781	8434035032880
Rojo	PRODUCTO	421301001133	421301000933	421301001033	421301001533
	EAN	8434035032842	8434035032743	8434035032798	8434035032897
Blanco	PRODUCTO	421301001144	421301000944	421301001044	421301001544
	EAN	8434035032859	8434035032750	8434035032804	8434035032903
Amarillo	PRODUCTO	421301001155	421301000955	421301001055	421301001555
	EAN	8434035032866	8434035032767	8434035032811	8434035032910

▶ Ud. Hilo replanteo 8842 PP trez.

Grosor / Thickness **1,8 mm** Resistencia / Breaking load **50 kg** Carga trabajo / Work load **15 kg**

1,8 mm



Bobina

	Código	25 m - 54 g	50 m - 90 g	100 m - 165 g	200 m - 300 g	500 m - 756 g
Verde	PRODUCTO	415301002211	415301001111	415301000911	415301001011	415301001511
	EAN	8434035031043	8434035030893	8434035030756	8434035030824	8434035030978
Azul	PRODUCTO	415301002222	415301001122	415301000922	415301001022	415301001522
	EAN	8434035031050	8434035030909	8434035030763	8434035030831	8434035030985
Rojo	PRODUCTO	415301002233	415301001133	415301000933	415301001033	415301001533
	EAN	8434035031067	8434035030916	8434035030770	8434035030848	8434035030992
Blanco	PRODUCTO	415301002244	415301001144	415301000944	415301001044	415301001544
	EAN	8434035031074	8434035030923	8434035030787	8434035030855	8434035031005
Amarillo	PRODUCTO	415301002255	415301001155	415301000955	415301001055	415301001555
	EAN	8434035031081	8434035030930	8434035030794	8434035030862	8434035031012
Negro	PRODUCTO	415301002266	415301001166	415301000966	415301001066	415301001566
	EAN	8434035031104	8434035030954	8434035030800	8434035030879	8434035031029
Naranja	PRODUCTO	415301002277	415301001177	415301000977	415301001077	415301001577
	EAN	8434035031111	8434035030961	8434035030817	8434035030886	8434035031036

▶ Ud. Hilo replanteo 8843 PP trez.

Grosor / Thickness **2,3 mm** Resistencia / Breaking load **68 kg** Carga trabajo / Work load **20,4 kg**

2,3 mm



Bobina

	Código	25 m - 62 g	50 m - 115 g	100 m - 240 g
Verde	PRODUCTO	436305002211	436305001111	436305000911
	EAN	8434035042964	8434035042933	8434035042896
Azul	PRODUCTO	436305002222	436305001122	436305000922
	EAN	8434035042971	8434035042940	8434035042902
Blanco	PRODUCTO	436305002244	436305001144	436305000944
	EAN	8434035042988	8434035042957	8434035042919

Hilo replanteo poliamida trenzado 1,3 a 2,3 mm

Polyamide braided thread 1,3 to 2,3 mm

Página 46 Tarifa. Page 46 Price List.

- **COMPOSICIÓN:** Hilo trenzado, de poliamida multifilamento de alta tenacidad protección solar.
- **CARACTERÍSTICAS:** Fibra suave y flexible, con gran resistencia a la tracción y al rozamiento, excelente anudabilidad.
- **APLICACIONES:** Efectos navales, albañilería, jardinería, horticultura, bricolaje, manualidades, paquetería, deporte.

- **COMPOSITION:** High tenacity braided polyamide multifilament yarns with UV protection.
- **FEATURES:** Soft and flexible fiber, very light with great tensile strength and abrasion resistance, excellent knotted.
- **APPLICATIONS:** Marine supplies, masonry, gardening, horticulture, gardening, crafts, packaging, sports, etc.



▶ Ud. Hilo replanteo 8840 PA trez. blanco

Grosor / Thickness **1,3 mm** Resistencia / Breaking load **40 kg** Carga trabajo / Work load **12 kg**

		Código	50 m - 70 g	100 m - 120 g	200 m - 200 g
Blanco	PRODUCTO	422301001144	422301000944	422301001044	
	EAN	8434035033030	8434035033016	8434035033023	



Bobina

▶ Ud. Hilo replanteo 8841 PA trez. blanco

Grosor / Thickness **1,5 mm** Resistencia / Breaking load **52 kg** Carga trabajo / Work load **15,6 kg**

		Código	50 m - 90 g	100 m - 160 g
Blanco	PRODUCTO	439301001144	439301000944	
	EAN	8434035044982	8434035044975	



Bobina

▶ Ud. Hilo replanteo 8842 PA trez. blanco

Grosor / Thickness **1,8 mm** Resistencia / Breaking load **74 kg** Carga trabajo / Work load **22,2 kg**

		Código	50 m - 100 g	100 m - 180 g	200 m - 345 g
Blanco	PRODUCTO	440301001144	440301000944	440301001044	
	EAN	8434035045064	8434035045040	8434035045057	



▶ Ud. Hilo replanteo 8843 PA trez. blanco

Grosor / Thickness **2,3 mm** Resistencia / Breaking load **104 kg** Carga trabajo / Work load **31,2 kg**

		Código	25 m - 84 g	50 m - 159 g	100 m - 290 g
Blanco	PRODUCTO	441301002244	441301001144	441301000944	
	EAN	8434035045170	8434035045163	8434035045156	



Hilo redondo poliamida 1,5 mm

Polyamide thread 1,5 mm

Página 46 Tarifa. Page 46 Price List.

- **COMPOSICIÓN:** Hilo trenzado con alma, de poliamida multifilamento de alta tenacidad protección solar.
- **CARACTERÍSTICAS:** Fibra suave y flexible, con gran resistencia a la tracción y al rozamiento, excelente anudabilidad.
- **APLICACIONES:** Cortinas, persianas, cierre bolsas, albañilería, deporte.

- **COMPOSITION:** High tenacity braided polyamide multifilament core.
- **FEATURES:** Soft and flexible fiber, very light with great tensile strength and abrasion resistance, excellent knotted.
- **APPLICATIONS:** Curtains, blinds, lock bags, masonry, sports.



▶ Ud. Cordón redondo 1,5 mm PA blanco

Grosor / Thickness **1,5 mm** Resistencia / Breaking load **69 kg** Carga trabajo / Work load **20,7 kg**

		Código	50 m - 90 g	100 m - 150 g	200 m - 300 g
Blanco	PRODUCTO	467301001144	467301000944	467301001044	
	EAN	8434035050938	8434035050914	8434035050921	



Bobina

Hilo replanteo poliéster trenzado colores 1,8 mm

Braided polyester color thread 1,8 mm

- **COMPOSICIÓN:** Hilo trenzado, de poliéster multifilamento de alta tenacidad protección solar.
- **CARACTERÍSTICAS:** Fibra suave y flexible, con excelente resistencia a la tracción y al rozamiento, excelente anudabilidad, gran visibilidad.
- **APLICACIONES:** Efectos navales, albañilería, jardinería, horticultura, bricolaje, manualidades, paquetería, deporte.

- **COMPOSITION:** High tenacity braided polyester multifilament yarns with UV protection.
- **FEATURES:** Soft and flexible fiber, very light with great tensile strength and abrasion resistance, excellent knotted, great visibility.
- **APPLICATIONS:** Marine supplies, masonry, gardening, horticulture, DIY, crafts, packaging, sports, etc.



Bobina

► Ud. Hilo replanteo 8842 PES trenzado colores

Grosor / Thickness **1,8 mm** Resistencia / Breaking load **72 kg** Carga trabajo / Work load **21,6 kg**

		Código 100 m - 205 g	
Blanco	PRODUCTO	499301000944	
	EAN	8434035056367	
Verde	PRODUCTO	499301000911	
	EAN	8434035056336	
Azul	PRODUCTO	499301000922	
	EAN	8434035056343	

		Código 100 m - 205 g	
Rojo	PRODUCTO	499301000933	
	EAN	8434035056350	
Amarillo	PRODUCTO	499301000955	
	EAN	8434035056381	
Negro	PRODUCTO	499301000966	
	EAN	8434035056398	



Bobina

► Ud. Hilo replanteo 8842 PES trenzado colores flúor

Grosor / Thickness **1,8 mm** Resistencia / Breaking load **72 kg** Carga trabajo / Work load **21,6 kg**

		Código 100 m - 205 g	
Naranja flúor	PRODUCTO	499301000970	
	EAN	8434035056404	
Amarillo flúor	PRODUCTO	499301000950	
	EAN	8434035056374	
Verde flúor	PRODUCTO	499301000910	
	EAN	8434035056329	



Hilo polipropileno cableado 1,1 a 1,4 mm

Polypropylene twisted thread 1,1 to 1,4 mm

Página 47 Tarifa. Page 47 Price List.

- **COMPOSICIÓN:** Hilo cableado, de polipropileno multifilamento de alta tenacidad protección solar.
- **CARACTERÍSTICAS:** Fibra suave y flexible, muy ligera con gran resistencia a la tracción, buena anudabilidad, resistente a la mayoría de los ácidos.
- **APLICACIONES:** Paquetería, etiquetaje, juguetería, jardinería, horticultura, trabajos manuales, industria, deporte.

- **COMPOSITION:** High tenacity cabled polypropylene multifilament thread with UV protection.
- **FEATURES:** Soft and flexible fiber, very light with great tensile strength, good knotted, and resistant to most chemicals.
- **APPLICATIONS:** Packaging, labeling, toys, gardening, horticulture, crafts, industry, sports.



Bobina

▶ Ud. Hilo PP cableado 1615 blanco

Grosor / Thickness **1,1 mm** Resistencia / Breaking load **20 kg** Carga trabajo / Work load **6 kg**

		Código	75 m - 60 g	140 m - 90 g	300 m - 170 g
Blanco	PRODUCTO		482301007144	482301006144	482301007044
	EAN		8434035052499	8434035052475	8434035052482



▶ Ud. Hilo PP cableado 1110 blanco

Grosor / Thickness **1,4 mm** Resistencia / Breaking load **24 kg** Carga trabajo / Work load **7,2 kg**

		Código	100 m - 91 g	200 m - 166 g	400 m - 310 g
Blanco	PRODUCTO		469302000944	469302001044	469302001344
	EAN		8434035051065	8434035051072	8434035051096



Hilo algodón 1 a 1,8 mm

Cotton thread 1 to 1,8 mm

Página 47 Tarifa. Page 47 Price List.

- **COMPOSICIÓN:** Hilo de algodón cableado.
- **CARACTERÍSTICAS:** Fibra suave y flexible, excelente anudabilidad.
- **APLICACIONES:** Industrias cárnicas, plumadas, floricultura, jardinería, juguetería, trabajos manuales, deporte, macramé.

- **COMPOSITION:** Cotton.
- **FEATURES:** Soft and flexible fiber, excellent knotted.
- **APPLICATIONS:** Meat industry, sinkers, floriculture, gardening, toys, crafts, sports, macrame.



Bobina

▶ Ud. Hilo algodón cableado 1 mm

Grosor / Thickness **1 mm** Resistencia / Breaking load **4 kg** Carga trabajo / Work load **1,2 kg**

		Código	50 m - 45 g	250 m - 160 g
Blanco	PRODUCTO		462001001144	462001002944
	EAN		8434035049888	8434035049895



▶ Ud. Hilo algodón cableado 1,5 mm

Grosor / Thickness **1,5 mm** Resistencia / Breaking load **8 kg** Carga trabajo / Work load **2,4 kg**

		Código	25 m - 50 g	50 m - 80 g	100 m - 150 g
Blanco	PRODUCTO		475301002244	475301001144	475301000944
	EAN		8434035051942	8434035051904	8434035051881



▶ Ud. Hilo algodón cableado 1,8 mm

Grosor / Thickness **1,8 mm** Resistencia / Breaking load **11 kg** Carga trabajo / Work load **3,3 kg**

		Código	25 m - 63 g	50 m - 105 g	100 m - 190 g
Blanco	PRODUCTO		475302002244	475302001144	475302000944
	EAN		8434035051980	8434035051973	8434035051959



Hilos de rafia de polipropileno 1,3 a 3,4 mm

Polypropylene raffia thread 1,3 to 3,4 mm

- **COMPOSICIÓN:** Hilo fibrilado, de polipropileno torcido a 1 cabo.
- **CARACTERÍSTICAS:** Hilo de buena tenacidad y muy ligero.
- **APLICACIONES:** Agricultura, paquetería, jardinería, bricolaje, invernaderos, deporte.

- **COMPOSITION:** Fibrillated twisted polypropylene thread with 1 strand.
- **FEATURES:** Good tenacity yarn and very light.
- **APPLICATIONS:** Agriculture, packaging, gardening, DIY, greenhouses, sports.



▶ Ud. Bobina rafia 400 1c 700 g



Bobina

400 m/kg	Grosor / Thickness 2,3 mm	Resistencia / Breaking load 64 kg	Carga trabajo / Work load 19,2 kg
-----------------	----------------------------------	--	--

Código 700 g

Blanco 1C	PRODUCTO	457000002644
	EAN	8434035048317
Negro 1C	PRODUCTO	457000002666
	EAN	8434035048324

2,3 mm

▶ Ud. Bobina rafia 600 1c

600 m/kg	Grosor / Thickness 1,7 mm	Resistencia / Breaking load 42 kg	Carga trabajo / Work load 12,6 kg
-----------------	----------------------------------	--	--

Código 120 g 200 g 400 g 700 g 2500 g

Blanco 1C	PRODUCTO	443000003844	443000002444	443000002544	443000002644	443000003544
	EAN	8434035045590	8434035045453	8434035045477	8434035045521	8434035045576
Negro 1C	PRODUCTO	443000003866	443000002466	443000002566	443000002666	443000003566
	EAN	8434035045606	8434035045460	8434035045484	8434035045545	8434035045583

▶ Ud. Bobina rafia 600 1c colores 700 g



Bobina

Verde	PRODUCTO	443000002611	Rojo	PRODUCTO	443000002633
	EAN	8434035045491		EAN	8434035045514
Azul	PRODUCTO	443000002622	Amarillo	PRODUCTO	443000002655
	EAN	8434035045507		EAN	8434035045538

1,7 mm

▶ Ud. Bobina rafia 900 1c

900 m/kg	Grosor / Thickness 1,4 mm	Resistencia / Breaking load 30 kg	Carga trabajo / Work load 9 kg
-----------------	----------------------------------	--	---------------------------------------

Código 100 g 200 g 400 g 700 g 2500 g

Blanco 1C	PRODUCTO	444000008044	444000002444	444000002544	444000002644	444000003544
	EAN	8434035045767	8434035045675	8434035045699	8434035045712	8434035045736
Negro 1C	PRODUCTO	444000008066	444000002466	444000002566	444000002666	444000003566
	EAN	8434035045774	8434035045682	8434035045705	8434035045729	8434035045743

▶ Ud. Bobina rafia 1200 mts 1c 700 g

1200 m/kg	Grosor / Thickness 1,3 mm	Resistencia / Breaking load 24 kg	Carga trabajo / Work load 7,2 kg
------------------	----------------------------------	--	---

Código 700 g

Blanco 1C	PRODUCTO	494000002644
	EAN	8434035055582
Negro 1C	PRODUCTO	494000002666
	EAN	8434035055599

1,3 mm



Bobina

▶ Ud. Bobina rafia 700 3c 700 g

250 m/kg	Grosor / Thickness 3,4 mm	Resistencia / Breaking load 140 kg	Carga trabajo / Work load 42 kg
-----------------	----------------------------------	---	--

Código 700 g

Beig 1C	PRODUCTO	465000002664
	EAN	8434035050013

3,4 mm

Hilos de rafia especial balas empacadora y rotoempacador

Special raffia thread ideal for packaging

Página 49 Tarifa. Page 49 Price List.

- **COMPOSICIÓN:** Hilo fibrilado, de polipropileno torcido a 1 cabo.
- **CARACTERÍSTICAS:** Hilo de buena tenacidad y muy ligero.
- **APLICACIONES:** Agricultura, paquetería, jardinería, bricolaje, invernaderos, deporte.

- **COMPOSITION:** Fibrillated polypropylene twisted threads with 1 strand.
- **FEATURES:** Yarn with a good tenacity and very light.
- **APPLICATIONS:** Agriculture, packaging, gardening, DIY, greenhouses, sports.



▶ Ud. Hilo rafia empacar 130 9 kg



Bobina

130 m/kg	Grosor / Thickness 5,2 mm	Resistencia / Breaking load 395 kg	Carga trabajo / Work load 118,5 kg
Azul	PRODUCTO 480001007622	Negro 480001007666	Naranja 480001007677
	EAN 8434035052291	8434035052307	8434035052314

▶ Ud. Hilo rafia empacar 150 9 kg

150 m/kg	Grosor / Thickness 4,5 mm	Resistencia / Breaking load 357 kg	Carga trabajo / Work load 107,1 kg
Azul	PRODUCTO 480000007622	Negro 480000007666	Naranja 480000007677
	EAN 8434035052260	8434035052277	8434035052284

▶ Ud. Hilo rafia empacar 300 5,5 kg



Bobina

300 m/kg	Grosor / Thickness 3 mm	Resistencia / Breaking load 140 kg	Carga trabajo / Work load 42 kg
Azul	PRODUCTO 480002008822	Negro 480002008866	Naranja 480002008877
	EAN 8434035052321	8434035052338	8434035052345

▶ Ud. Hilo rafia empacar 600 5 kg

600 m/kg	Grosor / Thickness 2 mm	Resistencia / Breaking load 100 kg	Carga trabajo / Work load 30 kg
Azul	PRODUCTO 480003005922	Negro 480003005966	Naranja 480003005977
	EAN 8434035052352	8434035052369	8434035052376



Azul



Negro



Naranja

Raffia 1200 polietileno butano

Raffia 1200 polyethylene

Página 49 Tarifa. Page 49 Price List.

- **COMPOSICIÓN:** Hilo laminado de polietileno.
- **CARACTERÍSTICAS:** Hilo de buena tenacidad y muy ligero.
- **APLICACIONES:** Agricultura, paquetería, jardinería, bricolaje, invernaderos, deporte.

- **COMPOSITION:** Fibrillated polypropylene twisted thread with 1 strand.
- **FEATURES:** Good tenacity yarn and very light.
- **APPLICATIONS:** Agriculture, packaging, gardening, DIY, greenhouses, sports.



▶ Ud. Bobina rafia PE butano



Bobina

1200 m/kg	Grosor / Thickness 1,4 mm	Resistencia / Breaking load 20 kg	Carga trabajo / Work load 6 kg
	Código 2 kg		
Butano	PRODUCTO 453001006277		
	EAN 8434035047570		

Butano



Cordón riel polipropileno 2,5 mm

Polypropylene rail cord 2,5 mm

Página 50 Tarifa. Page 50 Price List.

- **COMPOSICIÓN:** 100% Polipropileno alta tenacidad con protección UV. Trenzado con alma.
- **COMPOSITION:** 100% high tenacity polypropylene with UV protection. Core twisted.
- **CARACTERÍSTICAS:** Cordón semirrígido, muy ligero, posee flotabilidad y con gran resistencia a la tracción.
- **FEATURES:** Semi-rigid cord, very light, buoyant and has great tensile strength.
- **APLICACIONES:** Riel de cortinas, tenderos, camping, guía hilos.
- **APPLICATIONS:** Rails curtains, clothes line, camping, guide wire.



Bobina

► Ud. Cordón riel PP 2,5 mm blanco

Grosor / Thickness **2,5 mm** Resistencia / Breaking load **110 kg** Carga trabajo / Work load **33 kg**

		Código	50 m - 215 g	100 m - 420 g	200 m - 815 g
Blanco	PRODUCTO		424004001144	424004000944	424004001044
	EAN		8434035034013	8434035033986	8434035034006



Madeja

► Md. Cordón riel PP 2,5 mm blanco

		Código	10 m - 40 g	15 m - 60 g	20 m - 80 g	25 m - 100 g	30 m - 120 g
Blanco	PRODUCTO		424304001644	424304001744	424304001844	424304002244	424304001944
	EAN		8434035035232	8434035035249	8434035035256	8434035035270	8434035035263

Cordón riel poliamida 2,5 mm

Polyamide rail cord 2,5 mm

Página 50 Tarifa. Page 50 Price List.

- **COMPOSICIÓN:** 100% Poliamida alta tenacidad. Trenzado con alma.
- **COMPOSITION:** 100% high tenacity polyamide. Twisted core.
- **CARACTERÍSTICAS:** Cordón flexible, muy suave y con gran resistencia.
- **FEATURES:** Cord flexible, very soft and resistant.
- **APLICACIONES:** Decoración, juguetería, trabajos manuales, pulseras, pancartas.
- **APPLICATIONS:** Decoration, toys, crafts, bracelets, banners.



Bobina

► Ud. Cordón riel PA 2,5 mm blanco

Grosor / Thickness **2,5 mm** Resistencia / Breaking load **151 kg** Carga trabajo / Work load **45,3 kg**

		Código	100 m - 430 g	200 m - 860 g
Blanco	PRODUCTO		449004000944	449004001044
	EAN		8434035046276	8434035046283



Madeja

► Md. Cordón riel PA 2,5 mm blanco

		Código	10 m - 38 g	15 m - 57 g	20 m - 75 g	25 m - 93 g	30 m - 113 g
Blanco	PRODUCTO		449304001644	449304001744	449304001844	449304002244	449304001944
	EAN		8434035046313	8434035046320	8434035046337	8434035046351	8434035046344

Cordón polietileno 3 mm

Polyethylene cord 3 mm

- **COMPOSICIÓN:** Camisa exterior monofilamentos de polietileno de alta densidad, y en el interior material textil trenzado.
- **CARACTERÍSTICAS:** Cordón semirrígido, muy ligero y de poca elongación.
- **APLICACIONES:** Riel de cortinas, tenderos, camping, guía hilos.

- **COMPOSITION:** High density polyethylene monofilament in the outer jacket and inside textile.
- **FEATURES:** Semi-rigid cord, very light and low elongation.
- **APPLICATIONS:** Rail curtains, clothes line, camping, guide wire.



Bobina

► Ud. Cordón PE trenzado con alma 3 mm blanco

Grosor / Thickness	3 mm	Resistencia / Breaking load	56 kg	Carga trabajo / Work load	16,8 kg
--------------------	-------------	-----------------------------	--------------	---------------------------	----------------

Código **200 m - 850 g**

Blanco	PRODUCTO	431005001044
	EAN	8434035040472

3 mm



Madeja

► Md. Cordón PE trenzado con alma 3 mm blanco

		Código	10 m - 45 g	15 m - 65 g	20 m - 90 g	25 m - 110 g	30 m - 135 g
Blanco	PRODUCTO		431305001644	431305001744	431305001844	431305002244	431305001944
	EAN		8434035040533	8434035040540	8434035040557	8434035040571	8434035040564



Cordón fantasía poliéster 1,5 a 4 mm

Polyester fantasy cord 1,5 to 4 mm

Página 51 Tarifa. Page 51 Price List.

- **COMPOSICIÓN:** Camisa poliéster alta tenacidad, interior material textil trenzada con alma.
- **CARACTERÍSTICAS:** Cordón con mucha variedad de colores, flexibles, muy suaves y con gran resistencia.
- **APLICACIONES:** Decoración, juguetería, trabajos manuales, pulseras, pancartas, bricolaje.

- **COMPOSITION:** High tenacity polyester outer cover and inside made of textile.
- **FEATURES:** Cord with a wide color variety, flexible, very soft and resistant.
- **APPLICATIONS:** Decorations, toys, crafts, bracelets, banners, DIY.



► Ud. Cordón fantasía PES 1,5 mm 50 mtl

Grosor / Thickness **1,5 mm** Resistencia / Breaking load **79 kg** Carga trabajo / Work load **23,7 kg**



Bobina

Código **50 m - 115 g**

	PRODUCTO	
Negro	427001001166	
	EAN	8434035036314
Naranja flúor	427001001170	
	EAN	8434035036321
Amarillo flúor	427001001150	
	EAN	8434035036291
Verde flúor	427001001110	
	EAN	8434035036253
Azul	427001001122	
	EAN	8434035036277
Rojo	427001001133	
	EAN	8434035036284
Amarillo	427001001155	
	EAN	8434035036307
Verde	427001001111	
	EAN	8434035036260



1,5 mm

► Ud. Cordón fantasía PES 2,5 mm 100 mtl

Grosor / Thickness **2,5 mm** Resistencia / Breaking load **193 kg** Carga trabajo / Work load **57,9 kg**



Carrete

Código **60 m - 240 g** **100 m - 420 g**

	PRODUCTO	60 m - 240 g	100 m - 420 g
Azul	427404006722	427004000922	
	EAN	8434035037403	8434035036451
Verde	427404006711	427004000911	
	EAN	8434035037397	8434035036444
Verde flúor	427404006710	427004000910	
	EAN	8434035037380	8434035036437
Amarillo flúor	427404006750	427004000950	
	EAN	8434035037427	8434035036482
Rojo	427404006733	427004000933	
	EAN	8434035037410	8434035036468
Negro	427404006766	427004000966	
	EAN	8434035037441	8434035036505
Naranja flúor	427404006770	427004000970	
	EAN	8434035037458	8434035036512
Amarillo	427404006755	427004000955	
	EAN	8434035037434	8434035036499

2,5 mm

Cordón fantasía poliéster 1,5 a 4 mm

Polyester fantasy cord 1,5 to 4 mm

► Ud. Cordón fantasía PES 3 mm

Grosor / Thickness **3 mm** Resistencia / Breaking load **260 kg** Carga trabajo / Work load **78 kg**



Carrete



Carrete

		Código	50 m - 260 g	90 m - 470 g
Azul	PRODUCTO		427405001122	427405008822
	EAN		8434035037489	8434035037564
Verde	PRODUCTO		427405001111	427405008811
	EAN		8434035037472	8434035037557
Verde flúor	PRODUCTO		427405001110	427405008810
	EAN		8434035037465	8434035037540
Amarillo flúor	PRODUCTO		427405001150	427405008850
	EAN		8434035037502	8434035037588
Rojo	PRODUCTO		427405001133	427405008833
	EAN		8434035037496	8434035037571
Negro	PRODUCTO		427405001166	427405008866
	EAN		8434035037526	8434035037601
Naranja flúor	PRODUCTO		427405001170	427405008870
	EAN		8434035037533	8434035037618
Amarillo	PRODUCTO		427405001155	427405008855
	EAN		8434035037519	8434035037595



Madeja 25 m



3 mm

		Código	25 m - 115 g
Azul	PRODUCTO		427305002222
	EAN		8434035037106
Verde flúor	PRODUCTO		427305002210
	EAN		8434035037090
Amarillo flúor	PRODUCTO		427305002250
	EAN		8434035037120
Rojo	PRODUCTO		427305002233
	EAN		8434035037113
Naranja flúor	PRODUCTO		427305002270
	EAN		8434035037137

► Ud. Cordón fantasía PES 4 mm

Grosor / Thickness **4 mm** Resistencia / Breaking load **330 kg** Carga trabajo / Work load **99 kg**



Carrete



Carrete

		Código	25 m - 280 g	60 m - 560 g
Azul	PRODUCTO		427407002222	427407006722
	EAN		8434035037649	8434035037724
Verde	PRODUCTO		427407002211	427407006711
	EAN		8434035037632	8434035037717
Verde flúor	PRODUCTO		427407002210	427407006710
	EAN		8434035037625	8434035037700
Amarillo flúor	PRODUCTO		427407002250	427407006750
	EAN		8434035037663	8434035037748
Rojo	PRODUCTO		427407002233	427407006733
	EAN		8434035037656	8434035037731
Negro	PRODUCTO		427407002266	427407006766
	EAN		8434035037687	8434035037762
Naranja flúor	PRODUCTO		427407002270	427407006770
	EAN		8434035037694	8434035037779
Amarillo	PRODUCTO		427407002255	427407006755
	EAN		8434035037670	8434035037755



Madeja

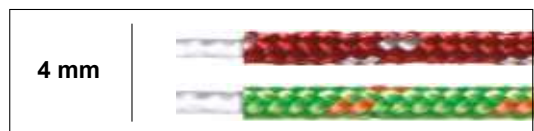

4 mm

		Código	15 m - 115 g
Azul	PRODUCTO		427307001722
	EAN		8434035037175
Verde flúor	PRODUCTO		427307001710
	EAN		8434035037168
Amarillo flúor	PRODUCTO		427307001750
	EAN		8434035037205
Rojo	PRODUCTO		427307001733
	EAN		8434035037182
Naranja flúor	PRODUCTO		427307001770
	EAN		8434035037212

Cuerda cableada polietileno 4 cabos plastificada

Coated polyethylene twisted cord 4 strands

- **COMPOSICIÓN:** Monofilamentos de polietileno de alta densidad torcidos y recubiertos de PVC.
- **COMPOSITION:** High tenacity polyethylene monofilament ropes, twisted and PVC-coated.
- **CARACTERÍSTICAS:** Cuerda flexible. Que no absorbe agua, de reducida elasticidad y de fácil limpieza.
- **FEATURES:** Flexible cord; does not absorb water, reduced elasticity and easy cleaning.
- **APLICACIONES:** Agricultura, pesca, tenderos de ropa, camping, cercados, efectos navales, persianas, bricolaje, usos deportivos.
- **APPLICATIONS:** Agriculture, fishing, clothes line, camping, fencing, chandlery, blinds, DIY, sports uses.



► Ud. Cuerda cableada PE 4c plastificada 4 mm

Grosor / Thickness 4 mm	Resistencia / Breaking load 55 kg	Carga trabajo / Work load 16,5 kg
--------------------------------	--	--



Balona

		Código	100 m - 750 g	200 m - 1500 g
Verde	PRODUCTO		459007000911	459007001011
	EAN		8434035048355	8434035048379
Blanco	PRODUCTO		459007000944	459007001044
	EAN		8434035048362	8434035048386



► Md. Cuerda cableada PE 4c plastificada 4 mm



Madeja

		Código	10 m - 75 g	15 m - 112 g	20 m - 150 g	25 m - 187 g	30 m - 225 g
Verde	PRODUCTO		459307001611	459307001711	459307001811	459307002211	459307001911
	EAN		8434035048577	8434035048591	8434035048614	8434035048652	8434035048638
Blanco	PRODUCTO		459307001644	459307001744	459307001844	459307002244	459307001944
	EAN		8434035048584	8434035048607	8434035048621	8434035048669	8434035048645

► Ud. Cuerda cableada PE 4c plastificada 5 mm

Grosor / Thickness 5 mm	Resistencia / Breaking load 95 kg	Carga trabajo / Work load 28,5 kg
--------------------------------	--	--



Balona

		Código	100 m - 2200 g	200 m - 4000 g
Verde	PRODUCTO		459009000911	459009001011
	EAN		8434035048416	8434035048430
Blanco	PRODUCTO		459009000944	459009001044
	EAN		8434035048423	8434035048447

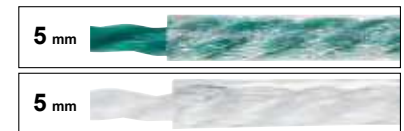

► Md. Cuerda cableada PE 4c plastificada 5 mm



Madeja

		Código	10 m - 200 g	15 m - 300 g	20 m - 400 g	25 m - 500 g	30 m - 600 g
Verde	PRODUCTO		459309001611	459309001711	459309001811	459309002211	459309001911
	EAN		8434035048676	8434035048690	8434035048713	8434035048751	8434035048737
Blanco	PRODUCTO		459309001644	459309001744	459309001844	459309002244	459309001944
	EAN		8434035048683	8434035048706	8434035048720	8434035048768	8434035048744

Cordón fantasía poliéster plastificada

Plastified polyester cord fantasy

Página 52 Tarifa. Page 52 Price List.

- **COMPOSICIÓN:** Cuerda de Poliéster 100% alta tenacidad trenzado, recubierto de PVC.
- **CARACTERÍSTICAS:** No absorbe agua. Reducida elasticidad y flexible. Fácil limpieza. Mantiene resistencia en condiciones de humedad.
- **APLICACIONES:** Tenderos de ropa, camping, cercados, efectos navales, toldos, persianas, bricolaje, camping, pancartas.

- **COMPOSITION:** 100% High tenacity polyester monofilament ropes, twisted and PVC-coated.
- **FEATURES:** Flexible cord, does not absorb water. Reduced elasticity and easy cleaning. Maintains resistance in humidity conditions.
- **APPLICATIONS:** Clothes lines, camping, fencing, chandlery, awnings, shutters, DIY, camping, banners.



► Md. Cordón Fantasía PES plastificada 5 mm



Grosor / Thickness **5 mm** Resistencia / Breaking load **179 kg** Carga trabajo / Work load **53,7 kg**

		Código	15 m - 300 g	25 m - 500 g
Naranja flúor	PRODUCTO		403309001770	403309002270
	EAN		8434035028456	8434035028470
Amarillo flúor	PRODUCTO		403309001750	403309002250
	EAN		8434035028449	8434035028463



Cable de acero plastificado 3,5 mm

PVC coated steel wire 3,5 mm

- **COMPOSICIÓN:** Cable de acero plastificado.
- **CARACTERÍSTICAS:** Cable maleable, que por su plastificado es fácil de limpiar, con muy poca elongación.
- **APLICACIONES:** Tendedores de ropa, camping, cercados, etc.

- **COMPOSITION:** PVC coated steel wire.
- **FEATURES:** Malleable cable, the plastic makes it easy to clean with a very little elongation.
- **APPLICATIONS:** Clothes line, camping, fencing, etc.



► Ud. Cable acero plastificado 3,5 mm

Grosor / Thickness **3,5 mm** Resistencia / Breaking load **90 kg** Carga trabajo / Work load **27 kg**



Balona

		Código	50 m - 800 g	100 m - 1500 g	200 m - 2900 g
Verde	PRODUCTO		483006001111	483006000911	483006001011
	EAN		8434035052574	8434035052536	8434035052550
Oro	PRODUCTO		483006001155	483006000955	483006001055
	EAN		8434035052581	8434035052543	8434035052567

3,5 mm



► Md. Cable acero plastificado 3,5 mm



Madeja

		Código	10 m - 140 g	15 m - 210 g	20 m - 280 g	25 m - 350 g
Verde	PRODUCTO		483306001611	483306001711	483306001811	483306002211
	EAN		8434035052666	8434035052680	8434035052703	8434035052727
Oro	PRODUCTO		483306001655	483306001755	483306001855	483306002255
	EAN		8434035052673	8434035052697	8434035052710	8434035052734



Cordón polipropileno alma texturada 4 a 6 mm

Polypropylene cord / textured core 4 to 6 mm

Página 53 Tarifa. Page 53 Price List.

- **COMPOSICIÓN:** Camisa polipropileno alta tenacidad, protección solar, interior material textil, trenzado con alma.
- **CARACTERÍSTICAS:** Cordón ligero y suave, posee flotabilidad no absorbe agua, buena anudabilidad.
- **APLICACIONES:** Tendederos de ropa, camping, cercados, efectos navales, persianas y bricolaje.

- **COMPOSITION:** Cord with high tenacity polypropylene outer cover and inside made of textured core, UV protection.
- **FEATURES:** Light and soft cord, buoyant and will not absorb water, excellent knotted.
- **APPLICATIONS:** Clothes line, camping, fencing, marine, shutters, DIY.



► Ud. Cordón PP 4mm alma texturada

Grosor / Thickness **4 mm** Resistencia / Breaking load **220 kg** Carga trabajo / Work load **66 kg**



Bobina 200 m

Código 200 m - 1550 g			Código 200 m - 1550 g		
Blanco	PRODUCTO	424007001044	Blanco Amarillo	PRODUCTO	424007001045
	EAN	8434035034211		EAN	8434035034228
Blanco Verde	PRODUCTO	424007001014	Blanco Marrón	PRODUCTO	424007001049
	EAN	8434035034181		EAN	8434035034235
Blanco Azul	PRODUCTO	424007001024	Tri - Color	PRODUCTO	424007001099
	EAN	8434035034198		EAN	8434035034242

4 mm



► Md. Cordón PP 4mm alma texturada



Madeja

		Código 10 m - 85 g	15 m - 120 g	20 m - 160 g	25 m - 190 g	30 m - 240 g
Blanco	PRODUCTO	424307001644	424307001744	424307001844	424307002244	424307001944
	EAN	8434035035324	8434035035362	8434035035430	8434035035515	8434035035478
Blanco Verde	PRODUCTO	424307001614	424307001714	424307001814	424307002214	424307001914
	EAN	8434035035300	8434035035348	8434035035416	8434035035492	8434035035454
Blanco Azul	PRODUCTO	424307001624	424307001724	424307001824	424307002224	424307001924
	EAN	8434035035317	8434035035355	8434035035423	8434035035508	8434035035461
Tri - Color	PRODUCTO	424307001699	424307001799	424307001899	424307002299	424307001999
	EAN	8434035035331	8434035035409	8434035035447	8434035035553	8434035035485

► Ud. Cordón PP 5mm alma texturada

Grosor / Thickness **5 mm** Resistencia / Breaking load **360 kg** Carga trabajo / Work load **108 kg**



Balanas 200 y 400 m

		Código 200 m - 2300 g	400 m - 4600 g
Blanco	PRODUCTO	424009001044	424009001344
	EAN	8434035034617	8434035034679
Blanco Verde	PRODUCTO	424009001014	424009001314
	EAN	8434035034594	8434035034655
Blanco Azul	PRODUCTO	424009001024	424009001324
	EAN	8434035034600	8434035034662
Blanco Marrón	PRODUCTO	424009001049	424009001349
	EAN	8434035034624	8434035034693

5 mm



► Ud. Cordón PP 6mm alma texturada

Grosor / Thickness **6 mm** Resistencia / Breaking load **450 kg** Carga trabajo / Work load **135 kg**



Balona 200 m

		Código 200 m - 4200 g
Blanco Verde	PRODUCTO	424010001014
	EAN	8434035034761
Tri - Color	PRODUCTO	424010001099
	EAN	8434035034808

6 mm



Cordón poliéster con alma 4 mm

Polyester cord textile core 4mm

- **COMPOSICIÓN:** Camisa poliéster alta tenacidad, protección UV, interior material textil, trenzado con alma.
- **CARACTERÍSTICAS:** Cordón flexible y suave, buena resistencia a la tracción y al rozamiento.
- **APLICACIONES:** Tenderos de ropa, camping, cercados, efectos navales, persianas y bricolaje.

- **COMPOSITION:** Braided cord high tenacity polyester exterior with textured core, UV protection.
- **FEATURES:** Flexible and soft cord, good tensile strength and abrasion resistant.
- **APPLICATIONS:** Clothes line, camping, fencing, marine, DIY, blinds.



► Ud. Cordón PES 4 mm con alma

Grosor / Thickness 4 mm	Resistencia / Breaking load 370 kg	Carga trabajo / Work load 111 kg
--------------------------------	---	---



Bobina

Código 200 m - 1800 g		
Blanco	PRODUCTO	487007001044
	EAN	8434035052826
Blanco Verde	PRODUCTO	487007001014
	EAN	8434035052802
Blanco Azul	PRODUCTO	487007001024
	EAN	8434035052819



► Md. Cordón PES 4mm alma texturada



Madeja

		Código	10 m - 95 g	15 m - 140 g	20 m - 190 g	25 m - 235 g	30 m - 280 g
Blanco	PRODUCTO		487307001644	487307001744	487307001844	487307002244	487307001944
	EAN		8434035053069	8434035053106	8434035053151	8434035053236	8434035053199
Blanco Verde	PRODUCTO		487307001614	487307001714	487307001814	487307002214	487307001914
	EAN		8434035053045	8434035053083	8434035053137	8434035053212	8434035053175
Blanco Azul	PRODUCTO		487307001624	487307001724	487307001824	487307002224	487307001924
	EAN		8434035053052	8434035053090	8434035053144	8434035053229	8434035053182





Cuerda arranque de motores

Starter cord

- **COMPOSICIÓN:** 100% poliéster alta tenacidad, trenzada con alma.
 - **CARACTERÍSTICAS:** Cordón suave, muy resistente a la tracción y a la abrasión.
 - **APLICACIONES:** Especial arranque de motores, camping, manualidades.
- **COMPOSITION:** 100% high tenacity polyester braided core.
 - **FEATURES:** Soft cord, abrasion and tensile resistance.
 - **APPLICATIONS:** Special engine starting, camping, crafts.



► Ud. Cuerda arranque motores 4 mm blanco

Grosor / Thickness **4 mm** Resistencia / Breaking load **407 kg** Carga trabajo / Work load **122,1 kg**



Balona

Madeja

		Código	25 m - 300 g	50 m - 600 g	100 m - 1040 g	200 m - 2080 g
Blanco	PRODUCTO		420007002244	420007001144	420007000944	420007001044
	EAN		8434035031722	8434035031715	8434035031692	8434035031708



Cuerda especial teléfonos 3 a 5 mm

Polyethylene twisted cord 3 to 5 mm

Página 55 Tarifa. Page 55 Price List.

- **COMPOSICIÓN:** Monofilamentos de polietileno torcidos a 3 cabos.
- **CARACTERÍSTICAS:** Cuerda flexible, no absorbe agua, de reducida elasticidad, flota en el agua, desliza con facilidad sobre cualquier superficie.
- **APLICACIONES:** Guía para pasar cables telefónicos y eléctricos.

- **COMPOSITION:** 3 strand twisted polyethylene monofilament ropes.
- **FEATURES:** Flexible cord, doesn't absorb water, reduced elasticity, floats on water and glides easily over any surface.
- **APPLICATIONS:** Special pass-thru guide for telephone and electric cables.



► Ud. Cuerda especial teléfonos 500 mtl negro



Bobina

Grosor / Thickness **3 mm** Carga trabajo / Work load **16,8 kg**

	Código	500 m - 2500 g
Negro	PRODUCTO	434005002366
	EAN	8434035041103



Grosor / Thickness **4 mm** Carga trabajo / Work load **21 kg**

	Código	500 m - 3660 g
Negro	PRODUCTO	434007002366
	EAN	8434035041271



Grosor / Thickness **5 mm** Carga trabajo / Work load **31,8 kg**

	Código	500 m - 5300 g
Negro	PRODUCTO	434009002366
	EAN	8434035041523



Cuerda cableada de polietileno 3 a 6 mm

Polyethylene twisted cord 3 to 6 mm

- **COMPOSICIÓN:** Monofilamentos de polietileno de alta densidad torcidos.
- **CARACTERÍSTICAS:** Cuerda flexible. No absorbe agua, de reducida elongación.
- **APLICACIONES:** Agricultura, pesca, tenderos de ropa, camping, cercados, efectos navales, persianas, bricolaje, usos deportivos.

- **COMPOSITION:** Monofilament of high density polyethylene twisted.
- **FEATURES:** Flexible cord. That does not absorb water, small elongation.
- **APPLICATIONS:** Agriculture, fishing, clothes line, camping, fencing, chandlery, blinds, DIY, sports uses.



▶ Ud. Cuerda cableada PE 4c 3 mm / 100 mtl

Grosor / Thickness 3 mm	Resistencia / Breaking load 56 kg	Carga trabajo / Work load 16,8 kg
--------------------------------	--	--



Bobina

		Código	100 m - 500 g
Verde	PRODUCTO		434005000911
	EAN		8434035041059
Azul	PRODUCTO		434005000922
	EAN		8434035041066
Blanco	PRODUCTO		434005000944
	EAN		8434035041073

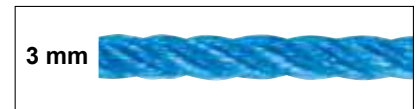

▶ Ud. Cuerda cableada PE 4c 4 mm

Grosor / Thickness 4 mm	Resistencia / Breaking load 70 kg	Carga trabajo / Work load 21 kg
--------------------------------	--	--



Bobina

		Código	100 m - 800 g	200 m - 1440 g
Verde	PRODUCTO		434007000911	434007001011
	EAN		8434035041110	8434035041158
Azul	PRODUCTO		434007000922	434007001022
	EAN		8434035041127	8434035041165
Blanco	PRODUCTO		434007000944	434007001044
	EAN		8434035041134	8434035041172
Negro	PRODUCTO		434007000966	434007001066
	EAN		8434035041141	8434035041189



▶ Md. Cuerda cableada PE 4c 4 mm



Madeja

		Código	10 m - 80 g	15 m - 120 g	20 m - 160 g	25 m - 200 g	30 m - 240 g
Verde	PRODUCTO		434307001611	434307001711	434307001811	434307002211	434307001911
	EAN		8434035042186	8434035042216	8434035042247	8434035042308	8434035042278
Blanco	PRODUCTO		434307001644	434307001744	434307001844	434307002244	434307001944
	EAN		8434035042193	8434035042223	8434035042254	8434035042322	8434035042285
Negro	PRODUCTO		434307001666	434307001766	434307001866	434307002266	434307001966
	EAN		8434035042209	8434035042230	8434035042261	8434035042339	8434035042292

Cuerda cableada de polietileno 3 a 6 mm

Polyethylene twisted cord 3 to 6 mm

► Ud. Cuerda cableada PE 4c 5 mm

Grosor / Thickness **5 mm** Resistencia / Breaking load **106 kg** Carga trabajo / Work load **31,8 kg**



Bobina

		Código	100 m - 1000 g	200 m - 2120 g
Verde	PRODUCTO		434009000911	434009001011
	EAN		8434035041301	8434035041356
Azul	PRODUCTO		434009000922	434009001022
	EAN		8434035041318	8434035041363
Blanco	PRODUCTO		434009000944	434009001044
	EAN		8434035041325	8434035041370
Negro	PRODUCTO		434009000966	434009001066
	EAN		8434035041349	8434035041387

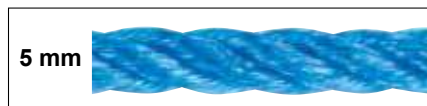

► Md. Cuerda cableada PE 4c 5 mm



Madeja

		Código	10 m - 95 g	15 m - 130 g	20 m - 200 g	25 m - 230 g	30 m - 300 g
Verde	PRODUCTO		434309001611	434309001711	434309001811	434309002211	434309001911
	EAN		8434035042346	8434035042384	8434035042421	8434035042490	8434035042469
Blanco	PRODUCTO		434309001644	434309001744	434309001844	434309002244	434309001944
	EAN		8434035042360	8434035042407	8434035042445	8434035042513	8434035042476
Negro	PRODUCTO		434309001666	434309001766	434309001866	434309002266	434309001966
	EAN		8434035042377	8434035042414	8434035042452	8434035042520	8434035042483

► Ud. Cuerda cableada PE 4c 6 mm

Grosor / Thickness **6 mm** Resistencia / Breaking load **353 kg** Carga trabajo / Work load **105,9 kg**



Bobina

		Código	100 m - 1800 g	200 m - 3240 g
Verde	PRODUCTO		434010000911	434010001011
	EAN		8434035041578	8434035041622
Azul	PRODUCTO		434010000922	434010001022
	EAN		8434035041585	8434035041639
Blanco	PRODUCTO		434010000944	434010001044
	EAN		8434035041592	8434035041646
Negro	PRODUCTO		434010000966	434010001066
	EAN		8434035041615	8434035041660



► Md. Cuerda cableada PE 4c 6 mm



Madeja

		Código	10 m - 148 g	15 m - 220 g	20 m - 340 g	25 m - 370 g	30 m - 450 g
Verde	PRODUCTO		434310001611	434310001711	434310001811	434310002211	434310001911
	EAN		8434035042551	8434035042582	8434035042612	8434035042674	8434035042643
Blanco	PRODUCTO		434310001644	434310001744	434310001844	434310002244	434310001944
	EAN		8434035042568	8434035042599	8434035042629	8434035042681	8434035042650
Negro	PRODUCTO		434310001666	434310001766	434310001866	434310002266	434310001966
	EAN		8434035042575	8434035042605	8434035042636	8434035042698	8434035042667

Cuerda algodón trenzada con alma 4 a 5 mm

Braided cotton rope 4 to 5 mm

Página 57 Tarifa. Page 57 Price List.

- **COMPOSICIÓN:** Algodón camisa, interior material textil, trenzado con alma.
- **CARACTERÍSTICAS:** Cuerda suave y flexible, seguridad en el nudo, tiene muy escasa elasticidad.
- **APLICACIONES:** Decoración, ganadería, macramé, agricultura, plomadas.

- **COMPOSITION:** Cotton outer cover and textured core, twisted.
- **FEATURES:** Soft and flexible rope, knot security, with a very low elasticity.
- **APPLICATIONS:** Decoration, animal husbandry, macramé, agriculture, plummets.



► Ud. Cuerda algodón trenzada c/alma 4 mm blanco



Bobina

Grosor / Thickness	4 mm	Resistencia / Breaking load	70 kg	Carga trabajo / Work load	21 kg
--------------------	------	-----------------------------	-------	---------------------------	-------

		Código	100 m - 800 g	200 m - 1600 g
Blanco	PRODUCTO		461007000944	461007001044
	EAN		8434035048942	8434035048959



► Ud. Cuerda algodón trenzada c/alma 4,5 mm blanco



Bobina

Grosor / Thickness	4,5 mm	Resistencia / Breaking load	80 kg	Carga trabajo / Work load	24 kg
--------------------	--------	-----------------------------	-------	---------------------------	-------

		Código	100 m - 900 g	200 m - 1800 g
Blanco	PRODUCTO		461008000944	461008001044
	EAN		8434035048973	8434035048980



► Ud. Cuerda algodón trenzada c/alma 5 mm blanco



Bobina

Grosor / Thickness	5 mm	Resistencia / Breaking load	110 kg	Carga trabajo / Work load	33 kg
--------------------	------	-----------------------------	--------	---------------------------	-------

		Código	100 m - 1200 g	200 m - 2400 g
Blanco	PRODUCTO		461009000944	461009001044
	EAN		8434035049048	8434035049055



► Md. Cuerda algodón trenzada c/alma 4,5 mm blanco



Madeja

Grosor / Thickness	4,5 mm	Resistencia / Breaking load	80 kg	Carga trabajo / Work load	24 kg
--------------------	--------	-----------------------------	-------	---------------------------	-------

		Código	10 m - 80 g	15 m - 120 g	20 m - 160 g	25 m - 200 g
Blanco	PRODUCTO		461308001644	461308001744	461308001844	461308002244
	EAN		8434035049505	8434035049512	8434035049529	8434035049536



Cuerda trenzada polipropileno 3 a 6 mm

Polypropylene braided cord 3 to 6 mm

Página 58 Tarifa. Page 58 Price List.

- **COMPOSICIÓN:** Cuerda trenzada de polipropileno multifilamento alta tenacidad protección solar.
- **CARACTERÍSTICAS:** Fibra suave y flexible, muy ligera posee flotabilidad, con gran resistencia a la tracción, buena anudabilidad, resistente a la mayoría de los ácidos.
- **APLICACIONES:** Albañilería, jardinería, horticultura, bricolaje, manualidades, paquetería, náutica, deporte, toldos persianas, confección.

- **COMPOSITION:** High tenacity polypropylene monofilament braided rope UV protected.
- **FEATURES:** Soft, flexible and very light fiber, buoyant with a great tensile strength and knot retention, resistant to most chemicals.
- **APPLICATIONS:** Masonry, gardening, horticulture, DIY, crafts, packaging, marine, sports, awnings, blinds, confection.



► Ud. Cuerda trenzada PP 3 mm TR8



Bobina

Grosor / Thickness 3 mm	Resistencia / Breaking load 150 kg	Carga trabajo / Work load 45 kg
--------------------------------	---	--

	Código	100 m - 470 g	200 m - 940 g
Blanco	PRODUCTO	423005000944	423005001044
	EAN	8434035033115	8434035033153



► Ud. Cuerda trenzada PP 4 mm TR8



Bobina

Grosor / Thickness 4 mm	Resistencia / Breaking load 188 kg	Carga trabajo / Work load 56,4 kg
--------------------------------	---	--

	Código	100 m - 660 g	200 m - 1300 g
Blanco	PRODUCTO	423007000944	423007001044
	EAN	8434035033252	8434035033313
Verde	PRODUCTO	423007000911	423007001011
	EAN	8434035033221	8434035033283
Azul	PRODUCTO	423007000922	423007001022
	EAN	8434035033238	8434035033290
Rojo	PRODUCTO	423007000933	423007001033
	EAN	8434035033245	8434035033306



► Ud. Cuerda trenzada PP 5 mm TR8



Bobina

Grosor / Thickness 5 mm	Resistencia / Breaking load 250 kg	Carga trabajo / Work load 75 kg
--------------------------------	---	--

	Código	100 m - 930 g	200 m - 1860 g
Blanco	PRODUCTO	423009000944	423009001044
	EAN	8434035033436	8434035033498
Verde	PRODUCTO	423009000911	423009001011
	EAN	8434035033405	8434035033450



► Ud. Cuerda trenzada PP 6 mm TR8



Bobina

Grosor / Thickness 6 mm	Resistencia / Breaking load 300 kg	Carga trabajo / Work load 90 kg
--------------------------------	---	--

	Código	100 m - 1800 g	200 m - 3600 g
Blanco	PRODUCTO	423010000944	423010001044
	EAN	8434035033610	8434035033641
Verde	PRODUCTO	423010000911	423010001011
	EAN	8434035033580	8434035033634



Cuerda trenzada poliéster 3 a 6 mm

Polyester braided cord 3 to 6 mm

Página 58-59 Tarifa. Page 58-59 Price List.

- **COMPOSICIÓN:** Poliéster 100% alta tenacidad protección solar, cuerda trenzada.
- **CARACTERÍSTICAS:** Fibra suave y flexible, con gran resistencia a la tracción y al rozamiento, excelente anudabilidad.
- **APLICACIONES:** Invernaderos, albañilería, jardinería, horticultura, bricolaje, manualidades, paquetería, náutica, deporte, toldos, persianas, confección.

- **COMPOSITION:** 100% high tenacity polyester UV protected rope.
- **FEATURES:** Soft and flexible fiber with a great tensile strength and abrasions resistance. Excellent knotted.
- **APPLICATIONS:** Greenhouses, masonry, gardening, Horticulture, DIY, crafts, packaging, marine, sports, awnings, blinds, confection.



► Ud. Cuerda trenzada PES 3 mm TR8



Bobina

Grosor / Thickness 3 mm	Resistencia / Breaking load 200 kg	Carga trabajo / Work load 60 kg
--------------------------------	---	--

	Código	100 m - 720 g	200 m - 1420 g
Blanco	PRODUCTO	419005000944	419005001044
	EAN	8434035031289	8434035031296



► Ud. Cuerda trenzada PES 4 mm TR8



Bobina

Grosor / Thickness 4 mm	Resistencia / Breaking load 254 kg	Carga trabajo / Work load 76,2 kg
--------------------------------	---	--

	Código	100 m - 1000 g	200 m - 1800 g
Blanco	PRODUCTO	419007000944	419007001044
	EAN	8434035031326	8434035031340



► Ud. Cuerda trenzada PES 5 mm TR8



Bobina

Grosor / Thickness 5 mm	Resistencia / Breaking load 300 kg	Carga trabajo / Work load 90 kg
--------------------------------	---	--

	Código	100 m - 1400 g	200 m - 2850 g
Blanco	PRODUCTO	419009000944	419009001044
	EAN	8434035031418	8434035031425



► Md. Cuerda trenzada PES 5 mm TR8



Madeja

Grosor / Thickness 5 mm	Resistencia / Breaking load 300 kg	Carga trabajo / Work load 90 kg
--------------------------------	---	--

	Código	10 m - 140 g	15 m - 140 g	20 m - 140 g	25 m - 140 g	30 m - 140 g
Blanco Rojo	PRODUCTO	419309001634	419309001734	419309001834	419309002234	419309001934
	EAN	8434035031623	8434035031630	8434035031647	8434035031661	8434035031654

► Ud. Cuerda trenzada PES 6 mm TR8



Bobina

Grosor / Thickness 6 mm	Resistencia / Breaking load 400 kg	Carga trabajo / Work load 120 kg
--------------------------------	---	---

	Código	100 m - 1800 g	200 m - 3600 g
Blanco	PRODUCTO	419010000944	419010001044
	EAN	8434035031487	8434035031500



Cuerda trenzada poliamida 3 a 6 mm

Polyamide braided cord 3 to 6 mm

Página 59 Tarifa. Page 59 Price List.

- **COMPOSICIÓN:** Cuerda trenzada, de poliamida de alta tenacidad protección solar.
- **CARACTERÍSTICAS:** Fibra suave y flexible, con gran resistencia a la tracción y al rozamiento, excelente anudabilidad.
- **APLICACIONES:** Albañilería, jardinería, horticultura, bricolaje manualidades, paquetería, náutica, deporte, toldos persianas, confección.

- **COMPOSITION:** Polyamide high tenacity braided UV protected rope.
- **FEATURES:** Soft and flexible fiber with a great tensile strength and abrasions resistance, excellent knotted.
- **APPLICATIONS:** Masonry, gardening, Horticulture, DIY, crafts, packaging, marine, sports, awnings, blinds and confection.



► Ud. Cuerda trenzada PA 3mm TR8



Bobina

Grosor / Thickness 3 mm	Resistencia / Breaking load 250 kg	Carga trabajo / Work load 75 kg
--------------------------------	---	--

	Código	100 m - 500 g
Blanco	PRODUCTO	412005000944
	EAN	8434035028722



► Ud. Cuerda trenzada PA 4mm TR8

Grosor / Thickness 4 mm	Resistencia / Breaking load 280 kg	Carga trabajo / Work load 84 kg
--------------------------------	---	--

	Código	100 m - 730 g	200 m - 1400 g
Blanco	PRODUCTO	412007000944	412007001044
	EAN	8434035028791	8434035028821



► Ud. Cuerda trenzada PA 5mm TR8



Bobina

Grosor / Thickness 5 mm	Resistencia / Breaking load 310 kg	Carga trabajo / Work load 93 kg
--------------------------------	---	--

	Código	100 m - 1180 g	200 m - 2350 g
Blanco	PRODUCTO	412009000944	412009001044
	EAN	8434035028951	8434035028982



► Ud. Cuerda trenzada PA 6mm TR8

Grosor / Thickness 6 mm	Resistencia / Breaking load 494 kg	Carga trabajo / Work load 148,2 kg
--------------------------------	---	---

	Código	100 m - 1550 g	200 m - 2960 g
Blanco	PRODUCTO	412010000944	412010001044
	EAN	8434035029033	8434035029064



Cuerda cableada de polipropileno 5 a 20 mm

Polypropylene twisted rope 5 to 20 mm

Página 60 Tarifa. Page 60 Price List.

- **COMPOSICIÓN:** Cuerda cableada, de polipropileno multifilamento de alta tenacidad protección solar.
- **CARACTERÍSTICAS:** Fibra suave y flexible, muy ligera posee flotabilidad con gran resistencia a la tracción, resistente a la mayoría de los ácidos.
- **APLICACIONES:** Agricultura, ganadería, remolques, pesca, náutica, decoración, parques infantiles, deporte.

- **COMPOSITION:** High tenacity polypropylene multifilament twisted rope, UV protected.
- **FEATURES:** Soft and flexible fiber, buoyant with a great tensile strength and resistant to most chemicals.
- **APPLICATIONS:** Agriculture, animal husbandry, trailers, fishing, navigation, decoration, playgrounds and sports.



Rollo

Grosor Thick	Metros Meters	Peso Weight	Resistencia Resistance	Código Producto Product code	Código EAN EAN code
5 mm	100 m	1,00 kg	427 kg	414009000944	8434035029354
5 mm	200 m	2,00 kg	427 kg	414009001044	8434035029361
6 mm	100 m	1,40 kg	568 kg	414010000944	8434035029392
6 mm	200 m	2,80 kg	568 kg	414010001044	8434035029408
8 mm	100 m	2,86 kg	912 kg	414012000944	8434035029507
10 mm	100 m	4,28 kg	1249 kg	414014000944	8434035029590
12 mm	100 m	5,80 kg	1735 kg	414016000944	8434035029682
14 mm	100 m	8,30 kg	2208 kg	414017000944	8434035029811
16 mm	100 m	10,14 kg	2959 kg	414018000944	8434035029880
18 mm	100 m	12,95 kg	3645 kg	414019000944	8434035029910
20 mm	100 m	15,80 kg	4300 kg	414020000944	8434035029934



10 mm

► Ud. Carrete cuerda cableada PP 4C blanco

Posibilidad producción colores
Color production possibility

Grosor / Thickness 6 mm	Resistencia / Breaking load 568 kg	Carga trabajo / Work load 170,4 kg
--------------------------------	---	---

Código	5 m	10 m	15 m	20 m	25 m	50 m
PRODUCTO	414010003744	414010001644	414410001744	414410001844	414410002244	414410001144
EAN	8434035029446	8434035029415	8434035029972	8434035029989	8434035030008	8434035029958

Presentación en madeja



Carrete

Grosor / Thickness 8 mm	Resistencia / Breaking load 912 kg	Carga trabajo / Work load 273,6 kg
--------------------------------	---	---

Código	5 m	10 m	15 m	20 m	25 m	50 m
PRODUCTO	414012003744	414412001644	414412001744	414412001844	414412002244	414412001144
EAN	8434035029569	8434035030046	8434035030053	8434035030060	8434035030077	8434035030039

Pres. en madeja



Carrete

Grosor / Thickness 10 mm	Resistencia / Breaking load 1249 kg	Carga trabajo / Work load 374,7 kg
---------------------------------	--	---

Código	5 m	10 m	15 m	20 m	25 m	50 m
PRODUCTO	414414003744	414414001644	414414001744	414414001844	414414002244	414414001144
EAN	8434035030176	8434035030121	8434035030138	8434035030145	8434035030152	8434035030114

Grosor / Thickness 12 mm	Resistencia / Breaking load 1735 kg	Carga trabajo / Work load 520,5 kg
---------------------------------	--	---

Código	5 m	10 m	15 m	20 m	25 m	50 m
PRODUCTO	414416003744	414416001644	414416001744	414416001844	414416002244	414416001144
EAN	8434035030251	8434035030213	8434035030220	8434035030237	8434035030244	8434035030206

Grosor / Thickness 14 mm	Resistencia / Breaking load 2208 kg	Carga trabajo / Work load 662,4 kg
---------------------------------	--	---

Código	5 m	10 m	15 m	20 m	25 m	50 m
PRODUCTO	414417003744	414417001644	414417001744	414417001844	414417002244	414417001144
EAN	8434035030312	8434035030275	8434035030282	8434035030299	8434035030305	8434035030268

Grosor / Thickness 16 mm	Resistencia / Breaking load 2959 kg	Carga trabajo / Work load 887,7 kg
---------------------------------	--	---

Código	5 m	10 m	15 m	20 m	25 m	50 m
PRODUCTO	414418003744	414418001644	414418001744	414418001844	414418002244	414418001144
EAN	8434035030381	8434035030343	8434035030350	8434035030367	8434035030374	8434035030336



Carrete

Cuerda de fibra ISO 1140 A poliamida

Polyamide fiber rope ISO 1140

Página 61 Tarifa. Page 61 Price List.

- **COMPOSICIÓN:** Cuerda cableada doble torsión, poliamida alta tenacidad protección UV.
- **CARACTERÍSTICAS:** Fibra suave y flexible, excelente resistencia a la tracción y a la fricción.
- **APLICACIONES:** Epi's, amarres, pesca, náutica, minería, construcción, elevación de cargas, usos que se necesite un producto de gran calidad.

- **COMPOSITION:** Double twisted cabled rope, high tenacity polyamide UV protection.
- **FEATURES:** Soft and flexible fiber, excellent tensile strength and friction.
- **APPLICATIONS:** Moorage, fishing, mining, construction, loads lifting, for applications that require product of high quality.



► Ud. Cuerda fibra ISO 1140 A PA2



Rollo

Grosor Thick	Metros Meters	Peso Weight	Resistencia Resistance	Código Producto Product code	Código EAN EAN code
10 mm	100 m	7,50 kg	2000 kg	455014000944	8434035047969
12 mm	100 m	8,60 kg	3000 kg	455016000944	8434035047990
14 mm	100 m	11,00 kg	4000 kg	455017000944	8434035048041
16 mm	100 m	15,00 kg	5000 kg	455018000944	8434035048096



10 mm



12 mm



14 mm



16 mm



Cuerda cableada polysteel

Polysteel twisted rope

Página 61 Tarifa. Page 61 Price List.

- **COMPOSICIÓN:** Monofilamentos de polysteel cableado.
 - **CARACTERÍSTICAS:** Cuerda flexible. No absorbe agua, de reducida elasticidad, que posee flotabilidad y excelente fuerza a la rotura.
 - **APLICACIONES:** Pesca, náutica, efectos navales, agricultura, ganadería, usos deportivos.
- **COMPOSITION:** Polysteel monofilament rope.
 - **FEATURES:** Flexible cord does not absorb water, reduced elasticity buoyant with excellent breaking strength.
 - **APPLICATIONS:** Fishing, Boating, marine supplies, agriculture, livestock, sporting uses.



► Ud. Cuerda cableada polysteel



Rollo

Grosor Thick	Metros Meters	Peso Weight	Resistencia Resistance	Código Producto Product code	Código EAN EAN code
6 mm	200 m	3,40 kg	581 kg	448010001011	8434035046030
8 mm	100 m	3,00 kg	1015 kg	448012000911	8434035046061
10 mm	100 m	4,40 kg	1500 kg	448014000911	8434035079250
12 mm	100 m	6,30 kg	2200 kg	448016000911	8434035079274
14 mm	100 m	8,60 kg	3000 kg	448017000911	8434035079281
16 mm	100 m	10,90 kg	3800 kg	448018000911	8434035098930
18 mm	100 m	14,00 kg	4800 kg	448019000911	8434035098923
20 mm	100 m	17,10 kg	5800 kg	448020000911	8434035098909

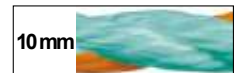

10mm

Hilo de pesca

Fishing line

Página 61 Tarifa. Page 61 Price List.

- **COMPOSICIÓN:** Monofilamento nylon.
 - **CARACTERÍSTICAS:** Alta resistencia.
 - **APLICACIONES:** Pesca, decoración, escaparatismo, usos textiles.
- **COMPOSITION:** Nylon monofilament.
 - **FEATURES:** High resistance.
 - **APPLICATIONS:** Fishing, decoration, window dressing, textile use.



► Ud. Hilo pesca monofilamento nylon



Carrete

Grosor Thick	Metros Meters	Código Producto Product code	Código EAN EAN code
0,35 mm	100 m	492003000900	8434035055520
0,40 mm	100 m	492001000900	8434035055506
0,55 mm	100 m	492002000900	8434035055513
0,80 mm	100 m	492008000944	8434035055568



Cuerda cableada polietileno 8 a 20 mm

Polyethylene twisted rope 8 to 20 mm

Página 62 Tarifa. Page 62 Price List.

- **COMPOSICIÓN:** Monofilamentos de polietileno de alta densidad torcidos.
- **CARACTERÍSTICAS:** Cuerda flexible. Que no absorbe agua, de reducida elasticidad, y que posee flotabilidad.
- **APLICACIONES:** Agricultura, pesca, tendedores de ropa, camping, cercados, efectos navales, persianas, bricolaje, usos deportivos.

- **COMPOSITION:** High tenacity polyethylene monofilament, twisted.
- **FEATURES:** Flexible cord, does not absorb water, reduced elasticity and buoyant.
- **APPLICATIONS:** Agriculture, fishing, clothes line, camping, fencing, chandlery, blinds, DIY, sports use.



► Ud. Cuerda cableada PE 4c

		Código 100 m - 2970 g	
Grosor / Thickness	8 mm	Verde 4C	PRODUCTO 434012000911 EAN 8434035041783
Resist. / Breaking load	617 kg	Azul 4C	PRODUCTO 434012000922 EAN 8434035041790
Carga trabajo / Work load	185,1 kg	Blanco 4C	PRODUCTO 434012000944 EAN 8434035041813

		Código 100 m - 14500 g	
Grosor / Thickness	18 mm	Verde 4C	PRODUCTO 434019000911 EAN 8434035042100
Resist. / Breaking load	3060 kg	Azul 4C	PRODUCTO 434019000922 EAN 8434035042117
Carga trabajo / Work load	918 kg	Blanco 4C	PRODUCTO 434019000944 EAN 8434035042124

		Código 100 m - 4400 g	
Grosor / Thickness	10 mm	Verde 4C	PRODUCTO 434014000911 EAN 8434035041851
Resist. / Breaking load	963 kg	Azul 4C	PRODUCTO 434014000922 EAN 8434035041868
Carga trabajo / Work load	288,9 kg	Blanco 4C	PRODUCTO 434014000944 EAN 8434035041875

		Código 100 m - 18000 g	
Grosor / Thickness	20 mm	Verde 4C	PRODUCTO 434020000911 EAN 8434035042148
Resist. / Breaking load	3770 kg	Azul 4C	PRODUCTO 434020000922 EAN 8434035042155
Carga trabajo / Work load	1131 kg	Blanco 4C	PRODUCTO 434020000944 EAN 8434035042162

		Código 100 m - 6500 g	
Grosor / Thickness	12 mm	Verde 4C	PRODUCTO 434016000911 EAN 8434035041929
Resist. / Breaking load	1360 kg	Azul 4C	PRODUCTO 434016000922 EAN 8434035041936
Carga trabajo / Work load	408 kg	Blanco 4C	PRODUCTO 434016000944 EAN 8434035041943



Rollo

		Código 100 m - 8600 g	
Grosor / Thickness	14 mm	Verde 4C	PRODUCTO 434017000911 EAN 8434035041998
Resist. / Breaking load	1840 kg	Azul 4C	PRODUCTO 434017000922 EAN 8434035042001
Carga trabajo / Work load	552 kg	Blanco 4C	PRODUCTO 434017000944 EAN 8434035042018

		Código 100 m - 11500 g	
Grosor / Thickness	16 mm	Verde 4C	PRODUCTO 434018000911 EAN 8434035042056
Resist. / Breaking load	2480 kg	Azul 4C	PRODUCTO 434018000922 EAN 8434035042063
Carga trabajo / Work load	744 kg	Blanco 4C	PRODUCTO 434018000944 EAN 8434035042070



Cuerda cableada nylon mate

Nylon mate twisted rope

Página 63 Tarifa. Page 63 Price List.

- **COMPOSICIÓN:** Cuerda cableada de nylon mate.
- **CARACTERÍSTICAS:** Fibra suave y flexible, buena resistencia al roce, buena capacidad de agarre.
- **APLICACIONES:** Agricultura, ganadería, remolques, pesca, náutica, decoración, tracción.

- **COMPOSITION:** Nylon mate cabled rope.
- **FEATURES:** Soft and flexible fiber, great abrasion resistance and grip strength.
- **APPLICATIONS:** Agriculture, animal husbandry, trailers, fishing, navigation, decoration, traction.

► Ud. Cuerda cableada nylon mate blanco



Rollo

Grosor Thick	Metros Meters	Peso Weight	Resistencia Resistance	Carga trabajo Work load	Código Producto Product code	Código EAN EAN code
5 mm	100 m	1,40 kg	230 kg	69 kg	438009000944	8434035044135
5 mm	200 m	2,80 kg	230 kg	69 kg	438009001044	8434035044142
6 mm	100 m	1,91 kg	310 kg	93 kg	438010000944	8434035044166
6 mm	200 m	3,82 kg	310 kg	93 kg	438010001044	8434035044173
8 mm	100 m	3,35 kg	516 kg	154,8 kg	438012000944	8434035044241
10 mm	100 m	5,40 kg	808 kg	242,4 kg	438014000944	8434035044333
12 mm	100 m	8,00 kg	1.079 kg	323,7 kg	438016000944	8434035044418
14 mm	100 m	10,20 kg	1.298 kg	389,4 kg	438017000944	8434035044487
16 mm	100 m	12,70 kg	1.667 kg	500,1 kg	438018000944	8434035044555
18 mm	100 m	19,70 kg	2.035 kg	610,5 kg	438019000944	8434035044586
20 mm	100 m	21,00 kg	2.320 kg	696 kg	438020000944	8434035044623

► Ud. Balona cuerda cableada nylon mate



Balona

Grosor Thick	Metros Meters	Peso Weight	Resistencia Resistance	Carga trabajo Work load	Código Producto Product code	Código EAN EAN code
6 mm	100 m	1,91 kg	310 kg	93 kg	438410000944	8434035044661
6 mm	200 m	3,82 kg	310 kg	93 kg	438410001044	8434035044678
8 mm	100 m	3,35 kg	516 kg	154,8 kg	438412000944	8434035044708
10 mm	100 m	5,40kg	808 kg	242,4 kg	438414000944	8434035044746
10 mm	50 m	2,70 kg	808 kg	242,4 kg	438414001144	8436019946770
12 mm	100 m	8,00 kg	1.079 kg	323,7 kg	438416000944	8434035044784
12 mm	50 m	4,00 kg	1.079 kg	323,7 kg	438416001144	8436019946787
14 mm	100 m	10,20 kg	1.298 kg	389,4 kg	438417000944	8434035044821
14 mm	50 m	5,10 kg	1.298 kg	389,4 kg	438417001144	8434035044838
16 mm	100 m	12,70 kg	1.667 kg	500,1 kg	438418000944	8434035044869
16 mm	50 m	6,35 kg	1.667 kg	500,1 kg	438418001144	8434035044876
18 mm	100 m	19,70 kg	2.035 kg	610,5 kg	438419000944	8434035044906
18 mm	50 m	9,85 kg	2.035 kg	610,5 kg	438419001144	8434035044913
20 mm	100 m	21,00 kg	2.320 kg	696 kg	438420000944	8434035105058
20 mm	50 m	10,50 kg	2.320 kg	696 kg	438420001144	8434035105041

Cuerda mate trenzada con alma

Nylon mate braided rope

Página 63 Tarifa. Page 63 Price List.

- **COMPOSICIÓN:** Textil blanco, cuerda trenzada con alma.
- **CARACTERÍSTICAS:** Fibra suave y flexible, no utilizar en trabajos que necesite gran resistencia.
- **APLICACIONES:** Náutica, juegos infantiles, toldos, decoración, manualidades, industria textil.

- **COMPOSITION:** Textile white rope with core.
- **FEATURES:** Soft and flexible fiber, do not use in jobs that require a high resistance.
- **APPLICATIONS:** Navigation, playgrounds, blinds, decoration, craft, textile industry.

► Ud. Cuerda nylon mate trenzada con alma blanco



Balona

Grosor Thick	Metros Meters	Peso Weight	Resistencia Resistance	Carga trabajo Work load	Código Producto Product code	Código EAN EAN code
5 mm	200 m	2,40 kg	170 kg	51 kg	442009001044	8434035045231
6 mm	200 m	3,60 kg	230 kg	69 kg	442010001044	8434035045293
8 mm	100 m	3,20 kg	325 kg	97,5 kg	442012000944	8434035045347
10 mm	100 m	5,70kg	688 kg	206,4 kg	442014000944	8434035045361
12 mm	100 m	7,50 kg	913 kg	273,9 kg	442016000944	8434035045385
14 mm	100 m	10,50 kg	1.170 kg	351 kg	442017000944	8434035045408
16 mm	100 m	13,26 kg	1.575 kg	472,5 kg	442018000944	8434035045422
18 mm	100 m	17,00 kg	1.900 kg	570 kg	442019000944	8434035045446

Cuerda polipropileno 100% trenzada con alma

100% polypropylene double braided rope

- **COMPOSICIÓN:** Alma y camisa polipropileno 100% alta tenacidad con tratamiento Anti V, trenzado con alma.
- **CARACTERÍSTICAS:** Fibra suave y flexible, muy ligera, posee flotabilidad con gran resistencia a la tracción, no se deteriora en el agua, resistente a la mayoría de los ácidos.
- **APLICACIONES:** Náutica, juegos infantiles, gimnasia rítmica, toldos, decoración, trabajos manuales, trabajos con poleas, tracción

- **COMPOSITION:** 100% high tenacity polypropylene core-outer cover with Anti V treatment.
- **FEATURES:** Soft, flexible, very light fiber, buoyant with a great tensile strength, does not deteriorate in water and resistant to most chemicals.
- **APPLICATIONS:** Navigations, playgrounds, gymnastics, awnings, decorations, crafts, work with pulleys, traction.



► Ud. Cuerda PPM trenzada con alma blanco



Balona

Grosor / Thick	Metros / Meters	Peso / Weight	Resistencia / Resistance	Código Producto / Product code	Código EAN / EAN code
6 mm	200 m	3,40 kg	668 kg	424010001044	8434035034792
8 mm	200 m	6,20 kg	1.126 kg	424012001044	8434035035065
10 mm	100 m	4,25 kg	1.270 kg	428014000944	8434035038011
12 mm	100 m	6,78kg	1.991 kg	428016000944	8434035038295
14 mm	100 m	9,00 kg	2.500 kg	428017000944	8434035038530
16 mm	100 m	10,82 kg	2.870 kg	428018000944	8434035038639
18 mm	100 m	14,92 kg	2.997 kg	428019000944	8434035038691
20 mm	100 m	17,13 kg	3.898 kg	428020000944	8434035038738



► Ud. Carrete cuerda PPM trenzada con alma blanco



Madeja

Grosor / Thickness 6 mm Resistencia / Breaking load 668 kg Carga trabajo / Work load 200,4 kg

Código	5 m	10 m	15 m	20 m	25 m	50 m
PRODUCTO	424010003744	424010001644	424410001744	424410001844	424410002244	424410001144
EAN	8434035034884	8434035034822	8434035035775	8434035035782	8434035035805	8434035035720

Presentación en madeja

Grosor / Thickness 8 mm Resistencia / Breaking load 1126 kg Carga trabajo / Work load 337,8 kg

Código	5 m	10 m	15 m	20 m	25 m	50 m
PRODUCTO	424012003744	424412001644	424412001744	424412001844	424412002244	424412001144
EAN	8434035035171	8434035035911	8434035035928	8434035035935	8434035035942	8434035035881

Pres. en madeja



Carrete

Grosor / Thickness 10 mm Resistencia / Breaking load 1270 kg Carga trabajo / Work load 381 kg

Código	5 m	10 m	15 m	20 m	25 m	50 m
PRODUCTO	428414003744	428414001644	428414001744	428414001844	428414002244	428414001144
EAN	8434035038851	8434035038783	8434035038790	8434035038806	8434035038820	8434035038752

Grosor / Thickness 12 mm Resistencia / Breaking load 1991 kg Carga trabajo / Work load 597,3 kg

Código	5 m	10 m	15 m	20 m	25 m	50 m
PRODUCTO	428416003744	428416001644	428416001744	428416001844	428416002244	428416001144
EAN	8434035038950	8434035038899	8434035038905	8434035038912	8434035038929	8434035038868

Grosor / Thickness 14 mm Resistencia / Breaking load 2500 kg Carga trabajo / Work load 750 kg

Código	5 m	10 m	15 m	20 m	25 m	50 m
PRODUCTO	428417003744	428417001644	428417001744	428417001844	428417002244	428417001144
EAN	8434035039056	8434035038998	8434035039001	8434035039018	8434035039025	8434035038967



Carrete

Grosor / Thickness 16 mm Resistencia / Breaking load 2870 kg Carga trabajo / Work load 861 kg

Código	5 m	10 m	15 m	20 m	25 m	50 m
PRODUCTO	428418003744	428418001644	428418001744	428418001844	428418002244	428418001144
EAN	8434035039117	8434035039070	8434035039087	8434035039094	8434035039100	8434035039063

Cuerda poliéster 100% trenzada con alma

100% polyester double braided rope

- **COMPOSICIÓN:** Alma y camisa poliéster 100% alta tenacidad, construcción trenzado con alma.
- **CARACTERÍSTICAS:** Fibra suave y flexible, con gran resistencia a la tracción y al rozamiento.
- **APLICACIONES:** Juegos infantiles, gimnasia rítmica, toldos, decoración, trabajos manuales, con poleas, tracción.

- **COMPOSITION:** 100% high tenacity polyester outer cover, braided core.
- **FEATURES:** Soft and flexible fiber, with great tensile strength and abrasion resistance.
- **APPLICATIONS:** Playgrounds, gymnastic, blends, decoration, crafts, work with pulleys, traction.



► Ud. Cuerda PES trenzada con alma blanco



Balona

Grosor / Thick	Metros / Meters	Peso / Weight	Resistencia / Resistance	Código Producto / Product code	Código EAN / EAN code
6 mm	200 m	4,20 kg	770 kg	420010001044	8434035031821
8 mm	200 m	8,40 kg	1.270 kg	420012001044	8434035032071
10 mm	100 m	7,00 kg	2.100 kg	429014000944	8434035039230
12 mm	100 m	10,80kg	2.550 kg	429016000944	8434035039469
14 mm	100 m	13,20 kg	3.530 kg	429017000944	8434035039667
16 mm	100 m	17,40 kg	4.300 kg	429018000944	8434035039742
18 mm	100 m	20,60 kg	5.596 kg	429019000944	8434035039810
20 mm	100 m	30,00 kg	6.300 kg	429020000944	8434035039841



► Ud. Cuerda PES trenzada con alma blanco



Madeja

Grosor / Thickness	Resistencia / Breaking load	Carga trabajo / Work load
6 mm	770 kg	231 kg

Código	5 m	10 m	15 m	20 m	25 m	50 m
PRODUCTO	420010003744	420010001644	420410001744	420410001844	420410002244	420410001144
EAN	8434035031913	8434035031852	8434035032361	8434035032385	8434035032392	8434035032330

Presentación en madeja



Carrete

Grosor / Thickness	Resistencia / Breaking load	Carga trabajo / Work load
8 mm	1270 kg	381 kg

Código	5 m	10 m	15 m	20 m	25 m	50 m
PRODUCTO	420012003744	420412001644	420412001744	420412001844	420412002244	420412001144
EAN	8434035032187	8434035032446	8434035032453	8434035032477	8434035032484	8434035032422

Pres. en madeja



Carrete

Grosor / Thickness	Resistencia / Breaking load	Carga trabajo / Work load
10 mm	2100 kg	630 kg

Código	5 m	10 m	15 m	20 m	25 m	50 m
PRODUCTO	429414003744	429414001644	429414001744	429414001844	429414002244	429414001144
EAN	8434035040076	8434035040007	8434035040014	8434035040038	8434035040045	8434035039988

Grosor / Thickness	Resistencia / Breaking load	Carga trabajo / Work load
12 mm	2550 kg	765 kg

Código	5 m	10 m	15 m	20 m	25 m	50 m
PRODUCTO	429416003744	429416001644	429416001744	429416001844	429416002244	429416001144
EAN	8434035040182	8434035040106	8434035040113	8434035040137	8434035040168	8434035040083

Grosor / Thickness	Resistencia / Breaking load	Carga trabajo / Work load
14 mm	3530 kg	1059 kg

Código	5 m	10 m	15 m	20 m	25 m	50 m
PRODUCTO	429417003744	429417001644	429417001744	429417001844	429417002244	429417001144
EAN	8434035040274	8434035040212	8434035040229	8434035040243	8434035040250	8434035040199

Grosor / Thickness	Resistencia / Breaking load	Carga trabajo / Work load
16 mm	4300 kg	1290 kg

Código	5 m	10 m	15 m	20 m	25 m	50 m
PRODUCTO	429418003744	429418001644	429418001744	429418001844	429418002244	429418001144
EAN	8434035040366	8434035040304	8434035040311	8434035040335	8434035040342	8434035040281

Cuerda poliéster flúor 100% trenzada con alma

100% polyester fluor double braided rope

Página 66 Tarifa. Page 66 Price List.

- **COMPOSICIÓN:** 100% Poliéster alta tenacidad, con protección UV, trenzado con alma.
- **CARACTERÍSTICAS:** Muy Visible, fibra suave y flexible, con gran resistencia a la tracción y al rozamiento.
- **APLICACIONES:** Señalización, juegos infantiles, gimnasia rítmica, toldos, decoración, trabajos con poleas, tracción, industria, náutica.

- **COMPOSITION:** 100% high tenacity polyester outer cover, braided core.
- **FEATURES:** Soft and flexible fiber, with great tensile strength and abrasion resistance.
- **APPLICATIONS:** Signaling, playgrounds, gymnastic, blends, decoration, crafts, work with pulleys, traction, navigation.



► Ud. Cuerda PES trenzada con alma amarillo flúor



Balona

Grosor / Thickness	6 mm		Resistencia / Breaking load	770 kg		Carga trabajo / Work load	231 kg	
Código	15 m - 320 g	25 m - 530 g	50 m - 1060 g	100 m - 2000 g	200 m - 4200 g			
PRODUCTO	420410001750	420410002250	420410001150	420010000950	420010001050			
EAN	8434035032378	8434035032408	8434035032347	8434035031814	8434035031838			

Grosor / Thickness	8 mm		Resistencia / Breaking load	1000 kg		Carga trabajo / Work load	300 kg	
Código	15 m - 630 g	25 m - 1050 g	50 m - 2100 g	100 m - 4000 g	200 m - 8400 g			
PRODUCTO	420412001750	420412002250	420412001150	420012000950	420012001050			
EAN	8434035032460	8434035032491	8434035032439	8434035032033	8434035032088			



Carrete

Grosor / Thickness	10 mm		Resistencia / Breaking load	1100 kg		Carga trabajo / Work load	330 kg	
Código	15 m - 1050 g	25 m - 1750 g	50 m - 3500 g	100 m - 7000 g				
PRODUCTO	429414001750	429414002250	429414001150	429014000950				
EAN	8434035040021	8434035040052	8434035039995	8434035039247				



Carrete

Grosor / Thickness	12 mm		Resistencia / Breaking load	1350 kg		Carga trabajo / Work load	405 kg	
Código	15 m - 1620 g	25 m - 2700 g	50 m - 5400 g	100 m - 10800 g				
PRODUCTO	429416001750	429416002250	429416001150	429016000950				
EAN	8434035040120	8434035040175	8434035040090	8434035039476				

Grosor / Thickness	14 mm		Resistencia / Breaking load	3530 kg		Carga trabajo / Work load	1059 kg	
Código	15 m - 1800 g	25 m - 3100 g	50 m - 6550 g	100 m - 13200 g				
PRODUCTO	429417001750	429417002250	429417001150	429017000950				
EAN	8434035040236	8434035040267	8434035040205	8434035039674				



Balona

Grosor / Thickness	16 mm		Resistencia / Breaking load	4300 kg		Carga trabajo / Work load	1290 kg	
Código	15 m - 2500 g	25 m - 4200 g	50 m - 8600 g	100 m - 17400 g				
PRODUCTO	429418001750	429418002250	429418001150	429018000950				
EAN	8434035040328	8434035040359	8434035040298	8434035039759				



Cuerda poliéster 100% trenzada con alma

100% Polyester color rope double braided

- **COMPOSICIÓN:** Alma y camisa poliéster 100% alta tenacidad, construcción trenzado con alma.
 - **CARACTERÍSTICAS:** Fibra suave y flexible, con gran resistencia a la tracción y al rozamiento.
 - **APLICACIONES:** Juegos infantiles, gimnasia rítmica, tol-dos, decoración, manualidades, trabajos con poleas, tracción.
- **COMPOSITION:** 100% high tenacity polyester outer cover, braided core.
 - **FEATURES:** Soft and flexible fiber, with great tensile strength and abrasion resistance.
 - **APPLICATIONS:** Playgrounds, gymnastic, blends, decoration, crafts, work with pulleys, traction.



► Ud. Cuerda PES trenzada con alma



Código **200 m - 8400 g**

Verde	PRODUCTO	420012001011
	EAN	8434035032040
Azul	PRODUCTO	420012001022
	EAN	8434035032057
Rojo	PRODUCTO	420012001033
	EAN	8434035032064
Negro	PRODUCTO	420012001066
	EAN	8434035032095

Grosor / Thickness	8 mm
Resist. / Breaking load	1270 kg
Carga trabajo / Work load	381 kg



Código **100 m - 10800 g**

Verde	PRODUCTO	429016000911
	EAN	8434035039421
Azul	PRODUCTO	429016000922
	EAN	8434035039438
Rojo	PRODUCTO	429016000933
	EAN	8434035039452
Negro	PRODUCTO	429016000966
	EAN	8434035039483

Grosor / Thickness	12 mm
Resist. / Breaking load	2550 kg
Carga trabajo / Work load	765 kg



Código **100 m - 7000 g**

Verde	PRODUCTO	429014000911
	EAN	8434035039193
Azul	PRODUCTO	429014000922
	EAN	8434035039209
Rojo	PRODUCTO	429014000933
	EAN	8434035039223
Negro	PRODUCTO	429014000966
	EAN	8434035039254

Grosor / Thickness	10 mm
Resist. / Breaking load	2100 kg
Carga trabajo / Work load	630 kg



Código **100 m - 13200 g**

Verde	PRODUCTO	429017000911
	EAN	8434035039636
Azul	PRODUCTO	429017000922
	EAN	8434035039643
Rojo	PRODUCTO	429017000933
	EAN	8434035039650
Negro	PRODUCTO	429017000966
	EAN	8434035039681

Grosor / Thickness	14 mm
Resist. / Breaking load	3530 kg
Carga trabajo / Work load	1059 kg



Cuerda poliéster 100% trenzada con alma

100% Polyester color rope double braided

► Ud. Carrete cuerda CTA 100 PES 6mm

Grosor / Thickness **6 mm** Resist. / Break load **770 kg** Carga trab. / Work load **231 kg**

Código		5 m	10 m	15 m	25 m	50 m	100 m	200 m
Verde	PRODUCTO	420310003711	420310001611	420410001711	420410002211	420410001111	420010000911	420010001011
	EAN	8434035111523	8434035111486	8434035111448	8434035111394	8434035111301	8434035113930	8434035111226
Azul	PRODUCTO	420310003722	420310001622	420410001722	420410002222	420410001122	420010000922	420010001022
	EAN	8434035111530	8434035111493	8434035111455	8434035111400	8434035111318	8434035111196	8434035111219
Rojo	PRODUCTO	420310003733	420310001633	420410001733	420410002233	420410001133	420010000933	420010001033
	EAN	8434035111554	8434035111509	8434035111462	8434035111417	8434035111325	8434035113954	8434035111233
Negro	PRODUCTO	420310003766	420310001666	420410001766	420410002266	420410001166	420010000966	420010001066
	EAN	8434035111561	8434035111516	8434035111479	8434035111424	8434035111332	8434035113961	8434035111240

Presentación en madeja

► Ud. Carrete cuerda CTA 100 PES 8mm

Grosor / Thickness **8 mm** Resist. / Break load **1270 kg** Carga trab. / Work load **381 kg**



Carrete

Código		10 m	15 m	25 m	50 m
Verde	PRODUCTO	420412001611	420412001711	420412002211	420412001111
	EAN	8434035111172	8434035111042	8434035111035	8434035111028
Azul	PRODUCTO	420412001622	420412001722	420412002222	420412001122
	EAN	8434035111141	8434035110649	8434035110656	8434035110632
Rojo	PRODUCTO	420412001633	420412001733	420412002233	420412001133
	EAN	8434035111165	8434035079380	8434035110946	8434035110939
Negro	PRODUCTO	420412001666	420412001766	420412002266	420412001166
	EAN	8434035111158	8434035110809	8434035110793	8434035110786

► Ud. Carrete cuerda CTA 100 PES 10mm

Grosor / Thickness **10 mm** Resist. / Break load **2100 kg** Carga trab. / Work load **630 kg**



Carrete

Código		15 m	25 m	50 m
Verde	PRODUCTO	429414001711	429414002211	429414001111
	EAN	8434035111073	8434035111066	8434035111059
Azul	PRODUCTO	429414001722	429414002222	429414001122
	EAN	8434035079342	8434035110700	8434035110670
Rojo	PRODUCTO	429414001733	429414002233	429414001133
	EAN	8434035110922	8434035110915	8434035110908
Negro	PRODUCTO	429414001766	429414002266	429414001166
	EAN	8434035110830	8434035110823	8434035110816

► Ud. Carrete cuerda CTA 100 PES 12mm

Grosor / Thickness **12 mm** Resist. / Break load **2550 kg** Carga trab. / Work load **765 kg**



Carrete

Código		15 m	25 m	50 m
Verde	PRODUCTO	429416001711	429416002211	429416001111
	EAN	8434035111103	8434035040144	8434035111080
Azul	PRODUCTO	429416001722	429416002222	429416001122
	EAN	8434035110731	8434035110724	8434035110717
Rojo	PRODUCTO	429416001733	429416002233	429416001133
	EAN	8434035110960	8434035040151	8434035110953
Negro	PRODUCTO	429416001766	429416002266	429416001166
	EAN	8434035110861	8434035110854	8434035110847

► Ud. Carrete cuerda CTA 100 PES 14mm

Grosor / Thickness **14 mm** Resist. / Break load **3530 kg** Carga trab. / Work load **1059 kg**



Carrete

Código		15 m	25 m	50 m
Verde	PRODUCTO	429417001711	429417002211	429417001111
	EAN	8434035111134	8434035111127	8434035111110
Azul	PRODUCTO	429417001722	429417002222	429417001122
	EAN	8434035110762	8434035110755	8434035110748
Rojo	PRODUCTO	429417001733	429417002233	429417001133
	EAN	8434035110991	8434035110984	8434035110977
Negro	PRODUCTO	429417001766	429417002266	429417001166
	EAN	8434035110892	8434035110885	8434035110878

Cuerda poliamida 100% trenzada con alma

100% polyamide double braided rope

- **COMPOSICIÓN:** 100% Poliamida alta tenacidad protección solar. Trenzado con alma.
- **CARACTERÍSTICAS:** Fibra suave y flexible, gran resistencia a la tracción y al rozamiento, no se deteriora en el agua.
- **APLICACIONES:** Náutica, juegos infantiles, gimnasia rítmica, toldos, decoración, manualidades, trabajos con poleas, tracción.

- **COMPOSITION:** 100% high tenacity braided polyamide rope, UV protection, with core.
- **FEATURES:** Soft and flexible fiber, with great tensile strength and abrasion resistance and does not deteriorate in water.
- **APPLICATIONS:** Navigations, playgrounds, gymnastic, blends, decoration, crafts, work with pulleys, traction.



► Ud. Cuerda PA trenzada con alma



Balona

Grosor Thick	Metros Meters	Peso Weight	Resistencia Resistance	Código Producto Product code	Código EAN EAN code
6 mm	200 m	3,78 kg	808 kg	427010001044	8434035036956
8 mm	200 m	7,56 kg	1.333 kg	427012001044	8434035037045
10 mm	100 m	6,30 kg	2.205 kg	432014000944	8434035040618
12 mm	100 m	9,72 kg	2.677 kg	432016000944	8434035040649
14 mm	100 m	11,88 kg	3.706 kg	432017000944	8434035040663
16 mm	100 m	15,66 kg	4.515 kg	432018000944	8434035040700
18 mm	100 m	18,54 kg	5.875 kg	432019000944	8434035040731
20 mm	100 m	27,00 kg	6.615 kg	432020000944	8434035040779



► Ud. Carrete cuerda PA trenzada con alma



Carrete

Grosor / Thickness 6 mm	Resistencia / Breaking load 808 kg	Carga trabajo / Work load 242,4 kg
--------------------------------	---	---

Código	5 m	10 m	15 m	20 m	25 m	50 m
PRODUCTO	427010003744	427010001644	427410001744	427410001844	427410002244	427410001144
EAN	8434035037007	8434035036970	8434035037809	8434035037816	8434035037823	8434035037786

Presentación en madeja

Grosor / Thickness 8 mm	Resistencia / Breaking load 1333 kg	Carga trabajo / Work load 399,9 kg
--------------------------------	--	---

Código	5 m	10 m	15 m	20 m	25 m	50 m
PRODUCTO	427012003744	427412001644	427412001744	427412001844	427412002244	427412001144
EAN	8434035037069	8434035037854	8434035037861	8434035037878	8434035037885	8434035037847

Pres. en madeja



Carrete

Grosor / Thickness 10 mm	Resistencia / Breaking load 2205 kg	Carga trabajo / Work load 661,5 kg
---------------------------------	--	---

Código	5 m	10 m	15 m	20 m	25 m	50 m
PRODUCTO	432414003744	432414001644	432414001744	432414001844	432414002244	432414001144
EAN	8434035040854	8434035040816	8434035040823	8434035040830	8434035040847	8434035040809

Grosor / Thickness 12 mm	Resistencia / Breaking load 2677 kg	Carga trabajo / Work load 803,1 kg
---------------------------------	--	---

Código	5 m	10 m	15 m	20 m	25 m	50 m
PRODUCTO	432416003744	432416001644	432416001744	432416001844	432416002244	432416001144
EAN	8434035040915	8434035040878	8434035040885	8434035040892	8434035040908	8434035040861



Carrete

Grosor / Thickness 14 mm	Resistencia / Breaking load 3706 kg	Carga trabajo / Work load 1111,8 kg
---------------------------------	--	--

Código	5 m	10 m	15 m	20 m	25 m	50 m
PRODUCTO	432417003744	432417001644	432417001744	432417001844	432417002244	432417001144
EAN	8434035040977	8434035040939	8434035040946	8434035040953	8434035040960	8434035040922

Grosor / Thickness 16 mm	Resistencia / Breaking load 4515 kg	Carga trabajo / Work load 1354,5 kg
---------------------------------	--	--

Código	5 m	10 m	15 m	20 m	25 m	50 m
PRODUCTO	432418003744	432418001644	432418001744	432418001844	432418002244	432418001144
EAN	8434035041035	8434035040991	8434035041004	8434035041011	8434035041028	8434035040984

Cuerda polipropileno trenzada alma mt

Polypropylene double braided rope mt-core

Página 69 Tarifa. Page 69 Price List.

- **COMPOSICIÓN:** Camisa polipropileno alta tenacidad, protección solar, interior material textil. Trenzado con alma.
- **CARACTERÍSTICAS:** Fibra suave y flexible.
- **APLICACIONES:** Náutica, toldos, decoración, trabajos manuales, trabajos con poleas y tracción.

- **COMPOSITION:** High tenacity polypropylene outer cover and inside made of textured core.
- **FEATURES:** Soft and flexible fiber.
- **APPLICATIONS:** Navigations, awnings, decorations, crafts, pulley work, traction.



► Ud. Cuerda PPM trenzada con alma mt blanco



Balona

Grosor Thick	Metros Meters	Peso Weight	Resistencia Resistance	Código Producto Product code	Código EAN EAN code
6 mm	200 m	3,40 kg	350 kg	491010001044	8434035054486
8 mm	200 m	6,24 kg	615 kg	491012001044	8434035054592
10 mm	100 m	4,68 kg	1.100 kg	491014000944	8434035054691
12 mm	100 m	6,87 kg	1.440 kg	491016000944	8434035054790
14 mm	100 m	9,81 kg	2.000 kg	491017000944	8434035054868
16 mm	100 m	12,88 kg	2.280 kg	491018000944	8434035054905
18 mm	100 m	15,85 kg	2.530 kg	491019000944	8434035054929
20 mm	100 m	19,08 kg	2.980 kg	491020000944	8434035054943

12 mm



► Ud. Carrete cuerda PPM trenzada con alma mt blanco

Grosor / Thickness 6 mm	Resistencia / Breaking load 350 kg	Carga trabajo / Work load 105 kg
--------------------------------	---	---

Código	5 m	10 m	15 m	20 m	25 m	50 m
PRODUCTO	491010003744	491010001644	491410001744	491410001844	491410002244	491410001144
EAN	8434035054547	8434035054509	8434035055001	8434035055018	8434035055032	8434035054974

Presentación en madeja



Carrete

Grosor / Thickness 8 mm	Resistencia / Breaking load 615 kg	Carga trabajo / Work load 184,5 kg
--------------------------------	---	---

Código	5 m	10 m	15 m	20 m	25 m	50 m
PRODUCTO	491012003744	491412001644	491412001744	491412001844	491412002244	491412001144
EAN	8434035054646	8434035055070	8434035055094	8434035055100	8434035055124	8434035055063

Pres. en madeja

Grosor / Thickness 10 mm	Resistencia / Breaking load 1100 kg	Carga trabajo / Work load 330 kg
---------------------------------	--	---

Código	5 m	10 m	15 m	20 m	25 m	50 m
PRODUCTO	491414003744	491414001644	491414001744	491414001844	491414002244	491414001144
EAN	8434035055223	8434035055162	8434035055186	8434035055193	8434035055216	8434035055155



Carrete

Grosor / Thickness 12 mm	Resistencia / Breaking load 1440 kg	Carga trabajo / Work load 432 kg
---------------------------------	--	---

Código	5 m	10 m	15 m	20 m	25 m	50 m
PRODUCTO	491416003744	491416001644	491416001744	491416001844	491416002244	491416001144
EAN	8434035055315	8434035055254	8434035055278	8434035055285	8434035055308	8434035055247

Grosor / Thickness 14 mm	Resistencia / Breaking load 2000 kg	Carga trabajo / Work load 600 kg
---------------------------------	--	---

Código	5 m	10 m	15 m	20 m	25 m	50 m
PRODUCTO	491417003744	491417001644	491417001744	491417001844	491417002244	491417001144
EAN	8434035055407	8434035055346	8434035055360	8434035055377	8434035055391	8434035055339



Carrete

Grosor / Thickness 16 mm	Resistencia / Breaking load 2280 kg	Carga trabajo / Work load 684 kg
---------------------------------	--	---

Código	5 m	10 m	15 m	20 m	25 m	50 m
PRODUCTO	491418003744	491418001644	491418001744	491418001844	491418002244	491418001144
EAN	8434035055490	8434035055438	8434035055452	8434035055469	8434035055483	8434035055421

Cuerda polipropileno trenzada alma mt amarillo / rojo

Polypropylene double braided rope-mt core yellow / red

Página 70 Tarifa. Page 70 Price List.

- **COMPOSICIÓN:** Camisa polipropileno alta tenacidad, protección solar, Interior material textil. Trenzado con alma.
- **CARACTERÍSTICAS:** Fibra suave y flexible.
- **APLICACIONES:** Náutica, toldos, decoración, trabajos manuales, trabajos con poleas, tracción.

- **COMPOSITION:** High tenacity polypropylene outer cover and inside made of textured core.
- **FEATURES:** Soft and flexible fiber.
- **APPLICATIONS:** Navigations, awnings, decorations, crafts, pulley work, traction.



► Ud. Cuerda PPM trenzada con alma mt amarillo / rojo



Balona

Grosor Thick	Metros Meters	Peso Weight	Resistencia Resistance	Código Producto Product code	Código EAN EAN code
6 mm	200 m	3,40 kg	350 kg	491010001035	8434035054479
8 mm	200 m	6,24 kg	615 kg	491012001035	8434035054585
10 mm	100 m	4,68 kg	1.100 kg	491014000935	8434035054684
12 mm	100 m	6,87 kg	1.440 kg	491016000935	8434035054783
14 mm	100 m	9,81 kg	2.000 kg	491017000935	8434035054851



► Ud. Carrete cuerda PPM trenzada con alma mt amarillo / rojo

Grosor / Thickness	6 mm	Resistencia / Breaking load	350 kg	Carga trabajo / Work load	105 kg
Código	15 m	25 m	50 m		
PRODUCTO	491410001735	491410002235	491410001135		
EAN	8434035054998	8434035055025	8434035054967		



Carrete

Grosor / Thickness	8 mm	Resistencia / Breaking load	615 kg	Carga trabajo / Work load	184,5 kg
Código	15 m	25 m	50 m		
PRODUCTO	491412001735	491412002235	491412001135		
EAN	8434035055087	8434035055117	8434035055056		



Carrete

Grosor / Thickness	10 mm	Resistencia / Breaking load	1100 kg	Carga trabajo / Work load	330 kg
Código	15 m	25 m	50 m		
PRODUCTO	491414001735	491414002235	491414001135		
EAN	8434035055179	8434035055209	8434035055148		

Grosor / Thickness	12 mm	Resistencia / Breaking load	1440 kg	Carga trabajo / Work load	432 kg
Código	15 m	25 m	50 m		
PRODUCTO	491416001735	491416002235	491416001135		
EAN	8434035055261	8434035055292	8434035055230		



Carrete

Grosor / Thickness	14 mm	Resistencia / Breaking load	2000 kg	Carga trabajo / Work load	600 kg
Código	15 m	25 m	50 m		
PRODUCTO	491417001735	491417002235	491417001135		
EAN	8434035055353	8434035055384	8434035055322		

Grosor / Thickness	16 mm	Resistencia / Breaking load	2280 kg	Carga trabajo / Work load	684 kg
Código	15 m	25 m	50 m		
PRODUCTO	491418001735	491418002235	491418001135		
EAN	8434035055445	8434035055476	8434035055414		

Cuerda poliéster trenzada alma mt

Polyester braided rope - mt core

Página 71 Tarifa. Page 71 Price List.

- **COMPOSICIÓN:** Camisa poliéster alta tenacidad, protección solar, interior material textil. Trenzado con alma.
- **CARACTERÍSTICAS:** Fibra suave y flexible.
- **APLICACIONES:** Toldos, decoración, trabajos manuales, trabajos con poleas, tracción.

- **COMPOSITION:** High tenacity polyester outer cover and core made from textile material.
- **FEATURES:** Soft and flexible fiber.
- **APPLICATIONS:** Awnings, decorations, crafts, pulley work, traction.



► Ud. Cuerda PES trenzada con alma mt blanco



Balona

Grosor Thick	Metros Meters	Peso Weight	Resistencia Resistance	Código Producto Product code	Código EAN EAN code
6 mm	200 m	3,80 kg	400 kg	488010001044	8434035053335
8 mm	200 m	7,20 kg	950 kg	488012001044	8434035053489
10 mm	100 m	5,40 kg	1.300 kg	488014000944	8434035053571
12 mm	100 m	7,60 kg	1.350 kg	488016000944	8434035053663
14 mm	100 m	10,50 kg	1.650 kg	488017000944	8434035053724
16 mm	100 m	13,30 kg	1.950 kg	488018000944	8434035053793
18 mm	100 m	15,30 kg	2.150 kg	488019000944	8434035053830
20 mm	100 m	21,00 kg	2.733 kg	488020000944	8434035053861



► Ud. Carrete cuerda PES trenzada con alma mt blanco



Carrete

Grosor / Thickness 6 mm Resistencia / Breaking load 400 kg Carga trabajo / Work load 120 kg

Código	5 m	10 m	15 m	20 m	25 m	50 m
PRODUCTO	488010003744	488010001644	488410001744	488410001844	488410002244	488410001144
EAN	8434035053427	8434035053366	8434035053892	8434035053908	8434035053915	8434035053878

Presentación en madeja



Carrete

Grosor / Thickness 8 mm Resistencia / Breaking load 950 kg Carga trabajo / Work load 285 kg

Código	5 m	10 m	15 m	20 m	25 m	50 m
PRODUCTO	488012003744	488412001644	488412001744	488412001844	488412002244	488412001144
EAN	8434035053533	8434035053946	8434035053960	8434035053977	8434035053991	8434035053939

Pres. en madeja



Carrete

Grosor / Thickness 10 mm Resistencia / Breaking load 1300 kg Carga trabajo / Work load 390 kg

Código	5 m	10 m	15 m	20 m	25 m	50 m
PRODUCTO	488414003744	488414001644	488414001744	488414001844	488414002244	488414001144
EAN	8434035054103	8434035054042	8434035054066	8434035054073	8434035054097	8434035054035

Grosor / Thickness 12 mm Resistencia / Breaking load 1350 kg Carga trabajo / Work load 405 kg

Código	5 m	10 m	15 m	20 m	25 m	50 m
PRODUCTO	488416003744	488416001644	488416001744	488416001844	488416002244	488416001144
EAN	8434035054202	8434035054141	8434035054165	8434035054172	8434035054196	8434035054134

Grosor / Thickness 14 mm Resistencia / Breaking load 1650 kg Carga trabajo / Work load 495 kg

Código	5 m	10 m	15 m	20 m	25 m	50 m
PRODUCTO	488417003744	488417001644	488417001744	488417001844	488417002244	488417001144
EAN	8434035054271	8434035054233	8434035054240	8434035054257	8434035054264	8434035054226

Grosor / Thickness 16 mm Resistencia / Breaking load 1950 kg Carga trabajo / Work load 585 kg

Código	5 m	10 m	15 m	20 m	25 m	50 m
PRODUCTO	488418003744	488418001644	488418001744	488418001844	488418002244	488418001144
EAN	8434035054332	8434035054295	8434035054301	8434035054318	8434035054325	8434035054288

Cuerda poliamida trenzada alma mt

Polyamide braided rope - mt core

Página 72 Tarifa. Page 72 Price List.

- **COMPOSICIÓN:** Camisa poliamida alta tenacidad, protección solar, interior material textil. Trenzado con alma.
- **COMPOSITION:** High tenacity polyamide outer cover and inside made of textured core.
- **CARACTERÍSTICAS:** Fibra suave y flexible.
- **FEATURES:** Soft and flexible fiber.
- **APLICACIONES:** Náutica, toldos, decoración, trabajos manuales, trabajos con poleas, tracción.
- **APPLICATIONS:** Navigations, awnings, decorations, crafts, pulley work, traction.



► Ud. Cuerda PA trenzada con alma mt blanco



Balona

Grosor Thick	Metros Meters	Peso Weight	Resistencia Resistance	Código Producto Product code	Código EAN EAN code
6 mm	200 m	3,61 kg	390 kg	466010001044	8434035050051
8 mm	200 m	6,84 kg	930 kg	466012001044	8434035050143
10 mm	100 m	5,13 kg	1.270 kg	466014000944	8434035050198
12 mm	100 m	7,22 kg	1.320 kg	466016000944	8434035050259
14 mm	100 m	9,97 kg	1.600 kg	466017000944	8434035050303
16 mm	100 m	12,63 kg	1.900 kg	466018000944	8434035050341
18 mm	100 m	14,53 kg	2.100 kg	466019000944	8434035050389
20 mm	100 m	19,95 kg	2.600 kg	466020000944	8434035050426



► Ud. Carrete cuerda PA trenzada con alma mt blanco

Grosor / Thickness	6 mm	Resistencia / Breaking load	390 kg	Carga trabajo / Work load	117 kg	
Código	5 m	10 m	15 m	20 m	25 m	50 m
PRODUCTO	466010003744	466010001644	466410001744	466410001844	466410002244	466410001144
EAN	8434035050112	8434035050075	8434035050518	8434035050525	8434035050532	8434035050495

Presentación en madeja



Carrete

Grosor / Thickness	8 mm	Resistencia / Breaking load	930 kg	Carga trabajo / Work load	279 kg	
Código	5 m	10 m	15 m	20 m	25 m	50 m
PRODUCTO	466012003744	466412001644	466412001744	466412001844	466412002244	466412001144
EAN	8434035050174	8434035050563	8434035050570	8434035050587	8434035050594	8434035050556

Pres. en madeja



Carrete

Grosor / Thickness	10 mm	Resistencia / Breaking load	1270 kg	Carga trabajo / Work load	381 kg	
Código	5 m	10 m	15 m	20 m	25 m	50 m
PRODUCTO	466414003744	466414001644	466414001744	466414001844	466414002244	466414001144
EAN	8434035050662	8434035050624	8434035050631	8434035050648	8434035050655	8434035050617

Grosor / Thickness	12 mm	Resistencia / Breaking load	1320 kg	Carga trabajo / Work load	396 kg	
Código	5 m	10 m	15 m	20 m	25 m	50 m
PRODUCTO	466416003744	466416001644	466416001744	466416001844	466416002244	466416001144
EAN	8434035050723	8434035050686	8434035050693	8434035050709	8434035050716	8434035050679

Grosor / Thickness	14 mm	Resistencia / Breaking load	1600 kg	Carga trabajo / Work load	480 kg	
Código	5 m	10 m	15 m	20 m	25 m	50 m
PRODUCTO	466417003744	466417001644	466417001744	466417001844	466417002244	466417001144
EAN	8434035050785	8434035050747	8434035050754	8434035050761	8434035050778	8434035050730



Carrete

Grosor / Thickness	16 mm	Resistencia / Breaking load	1900 kg	Carga trabajo / Work load	570 kg	
Código	5 m	10 m	15 m	20 m	25 m	50 m
PRODUCTO	466418003744	466418001644	466418001744	466418001844	466418002244	466418001144
EAN	8434035050846	8434035050808	8434035050815	8434035050822	8434035050839	8434035050792

Cuerda algodón trenzada con alma

Cotton braided rope

Página 73 Tarifa. Page 73 Price List.

- **COMPOSICIÓN:** Algodón, material textil, cuerda trenzada con alma.
- **COMPOSITION:** Cotton, textile material, braided rope with core.
- **CARACTERÍSTICAS:** Cuerda suave y flexible, aumenta la tenacidad al ir mezclado con poliéster, seguridad en el nudo, tiene muy escasa elasticidad.
- **FEATURES:** Soft and flexible rope, the tenacity increases by being mixed with polyester, knot security, with very low elasticity.
- **APLICACIONES:** Decoración, ganadería, macramé, agricultura, plomadas.
- **APPLICATIONS:** Decoration, animal husbandry, macrame, agriculture, plummet.



► Ud. Cuerda algodón trenzada con alma blanco



Balona

Grosor Thick	Metros Meters	Peso Weight	Resistencia Resistance	Código Producto Product code	Código EAN EAN code
6 mm	100 m	1,60 kg	150 kg	46101000944	8434035049079
6 mm	200 m	3,20 kg	150 kg	461010001044	8434035049086
8 mm	100 m	2,80 kg	390 kg	46101200944	8434035049161
10 mm	100 m	4,60 kg	670 kg	46101400944	8434035049246
12 mm	100 m	7,40kg	900 kg	46101600944	8434035049321
14 mm	100 m	9,20 kg	1.100 kg	46101700944	8434035049383
16 mm	100 m	13,00 kg	1.400 kg	46101800944	8434035049406
18 mm	100 m	17,00 kg	1.700 kg	46101900944	8434035049420
20 mm	100 m	20,00 kg	1.900 kg	46102000944	8434035049444



► Ud. Carrete cuerda algodón trenzada con alma blanco

	Código	5 m	10 m	15 m	20 m	25 m	50 m
6 mm	PRODUCTO	461010003744	461010001644	461410001744	461410001844	461410002244	461410001144
	EAN	8434035049130	8434035049093	8434035049598	8434035049604	8434035049611	8434035049581
Presentación en madeja							

	Código	5 m	10 m	15 m	20 m	25 m	50 m
8 mm	PRODUCTO	461012003744	461012001644	461412001744	461412001844	461412002244	461412001144
	EAN	8434035049222	8434035049635	8434035049642	8434035049659	8434035049666	8434035049628
Pres. en madeja							

	Código	5 m	10 m	15 m	20 m	25 m	50 m
10 mm	PRODUCTO	461414003744	461414001644	461414001744	461414001844	461414002244	461414001144
	EAN	8434035049727	8434035049680	8434035049697	8434035049703	8434035049710	8434035049673

	Código	5 m	10 m	15 m	20 m	25 m	50 m
12 mm	PRODUCTO	461416003744	461416001644	461416001744	461416001844	461416002244	461416001144
	EAN	8434035049789	8434035049741	8434035049758	8434035049765	8434035049772	8434035049734

	Código	5 m	10 m	15 m	20 m	25 m	50 m
14 mm	PRODUCTO	461417003744	461417001644	461417001744	461417001844	461417002244	461417001144
	EAN	8434035049840	8434035049802	8434035049819	8434035049826	8434035049833	8434035049796



Carrete



Cuerda elástica

Elastic rope

- **COMPOSICIÓN:** Camisa en polipropileno y poliéster dependiendo del color, interior látex. Trenzado con alma.
- **APLICACIONES:** Sujeción de paquetes en superficies móviles, redes de contenedor, industria del automóvil, toldos, pancartas, náutica.

- **COMPOSITION:** Polyester or polypropylene outer cover, according to the color, interior latex.
- **APPLICATIONS:** Securing of packages on moving surfaces, Container nets, automobile industry, awnings, and navigation.



▶ Ud. Cuerda elástica PES 4mm/200mtl

Grosor / Thickness **4 mm**



Balona

		Código 200 m - 2540 g	
Blanco	PRODUCTO	451007001044	
	EAN	8434035046504	
Negro	PRODUCTO	451007001066	
	EAN	8434035046511	
Azul	PRODUCTO	451007001022	
	EAN	8434035046498	

▶ Ud. Cuerda elástica PES 10mm/100mtl

Grosor / Thickness **10 mm**



Balona

		Código 100 m - 8130 g	
Blanco	PRODUCTO	451014000944	
	EAN	8434035046931	
Negro	PRODUCTO	451014000966	
	EAN	8434035046948	
Azul	PRODUCTO	451014000922	
	EAN	8434035046924	

▶ Ud. Cuerda elástica PES 5mm/200mtl

Grosor / Thickness **5 mm**



Balona

		Código 200 m - 3500 g	
Blanco	PRODUCTO	451009001044	
	EAN	8434035046542	
Negro	PRODUCTO	451009001066	
	EAN	8434035046559	
Azul	PRODUCTO	451009001022	
	EAN	8434035046535	

▶ Ud. Cuerda elástica PES 12mm/100mtl

Grosor / Thickness **12 mm**



Balona

		Código 100 m - 10600 g	
Blanco	PRODUCTO	451016000944	
	EAN	8434035046962	
Negro	PRODUCTO	451016000966	
	EAN	8434035046979	
Azul	PRODUCTO	451016000922	
	EAN	8434035046955	

▶ Ud. Cuerda elástica PES 6mm/200mtl

Grosor / Thickness **6 mm**



Balona

		Código 200 m - 6380 g	
Blanco	PRODUCTO	451010001044	
	EAN	8434035046610	
Negro	PRODUCTO	451010001066	
	EAN	8434035046627	
Azul	PRODUCTO	451010001022	
	EAN	8434035046603	

▶ Ud. Cuerda elástica PES 8mm/100mtl

Grosor / Thickness **8 mm**



Balona

		Código 100 m - 5300 g	
Blanco	PRODUCTO	451012000944	
	EAN	8434035046801	
Negro	PRODUCTO	451012000966	
	EAN	8434035046818	
Azul	PRODUCTO	451012000922	
	EAN	8434035046788	



Cuerda elástica

Elastic rope

► Ud. Carrete cuerda elástica PES 6 mm



Carrete

Código		5 m	10 m	15 m	20 m	25 m	50 m
Negro	PRODUCTO	451010003766	451010001666	451410001766	451410001866	451410002266	451410001166
	EAN	8434035046719	8434035046658	8434035047075	8434035047105	8434035047136	8434035047013
Blanco	PRODUCTO	451010003744	451010001644	451410001744	451410001844	451410002244	451410001144
	EAN	8434035046702	8434035046641	8434035047068	8434035047099	8434035047129	8434035047006
Azul	PRODUCTO	451010003722	451010001622	451410001722	451410001822	451410002222	451410001122
	EAN	8434035046696	8434035046634	8434035047051	8434035047082	8434035047112	8434035046993

Presentación en madeja

► Ud. Carrete cuerda elástica PES 8 mm



Carrete

Código		5 m	10 m	15 m	20 m	25 m	50 m
Negro	PRODUCTO	451012003766	451412001666	451412001766	451412001866	451412002266	451412001166
	EAN	8434035046900	8434035047242	8434035047273	8434035047303	8434035047334	8434035047211
Blanco	PRODUCTO	451012003744	451412001644	451412001744	451412001844	451412002244	451412001144
	EAN	8434035046894	8434035047235	8434035047266	8434035047297	8434035047327	8434035047204
Azul	PRODUCTO	451012003722	451412001622	451412001722	451412001822	451412002222	451412001122
	EAN	8434035046887	8434035047228	8434035047259	8434035047280	8434035047310	8434035047198

Pres. en madeja

► Ud. Carrete cuerda elástica PES 10 mm



Carrete

Código		5 m	10 m	15 m	20 m	25 m	50 m
Negro	PRODUCTO	451414003766	451414001666	451414001766	451414001866	451414002266	451414001166
	EAN	8434035047549	8434035047426	8434035047457	8434035047488	8434035047518	8434035047396
Blanco	PRODUCTO	451414003744	451414001644	451414001744	451414001844	451414002244	451414001144
	EAN	8434035047532	8434035047419	8434035047440	8434035047471	8434035047501	8434035047389
Azul	PRODUCTO	451414003722	451414001622	451414001722	451414001822	451414002222	451414001122
	EAN	8434035047525	8434035047402	8434035047433	8434035047464	8434035047495	8434035047372

Pulpos goma elástica

Elastic bungee cord

► Ud. Pulpo goma elástica 8mm/1mtl

Grosor / Thickness **8 mm**

Código **1 m - 95 g**



Pulpo

Verde	PRODUCTO	498012008711
	EAN	8434035056190
Azul	PRODUCTO	498012008722
	EAN	8434035056206

► Ud. Pulpo goma elástica 8mm/1,5mtl

Grosor / Thickness **8 mm**

Código **1,5 m - 116 g**



Pulpo

Verde	PRODUCTO	498012006911
	EAN	8434035056176
Azul	PRODUCTO	498012006922
	EAN	8434035056183



Puedes encontrar, también, esta referencia en la familia Elásticos y Trincajes you can also find this reference in Bungey and Tie down

Cuerda polipropileno 100% trenzada con alma

100% polypropylene double braided rope

Página 76 Tarifa. Page 76 Price List.

- **COMPOSICIÓN:** Alma y camisa polipropileno 100% alta tenacidad con tratamiento Anti V, trenzado con alma.
- **CARACTERÍSTICAS:** Fibra suave y flexible, muy ligera, posee flotabilidad con gran resistencia a la tracción, no se deteriora en el agua, resistente a la mayoría de los ácidos.
- **APLICACIONES:** Náutica, juegos infantiles, gimnasia rítmica, toldos, decoración, trabajos manuales, trabajos con poleas, tracción.

- **COMPOSITION:** 100% high tenacity polypropylene core-outer cover with Anti V treatment.
- **FEATURES:** Soft, flexible, very light fiber, buoyant with a great tensile strength, does not deteriorate in water and resistant to most chemicals.
- **APPLICATIONS:** Navigations, playgrounds, gymnastics, awnings, decorations, crafts, work with pulleys, traction.



► Cuerda PPM trenzada con alma

Grosor / Thickness **2,5 mm** Resistencia / Breaking load **85 kg** Carga trabajo / Work load **25,5 kg**



Carrete

		Código	25 m	60 m	110 m
Camel	PRODUCTO	424304002264	424404006764	424404006464	
	EAN	8434035035287	8434035035645	8434035035621	
Verde oscuro	PRODUCTO	424304002291	424404006791	424404006491	
	EAN	8434035035294	8434035035652	8434035035638	

Pres. en madeja

Grosor / Thickness **4 mm** Resistencia / Breaking load **188 kg** Carga trabajo / Work load **56,4 kg**



Madeja

		Código	15 m	25 m	45 m	80 m
Camel	PRODUCTO	424307001764	424307002264	424407006664	424407003064	
	EAN	8434035035386	8434035035539	8434035035683	8434035035669	
Verde oscuro	PRODUCTO	424307001791	424307002291	424407006691	424407003091	
	EAN	8434035035393	8434035035546	8434035035690	8434035035676	

Presentación en madeja

Grosor / Thickness **5 mm** Resistencia / Breaking load **266 kg** Carga trabajo / Work load **79,8 kg**



Carrete

		Código	15 m	45 m	100 m
Camel	PRODUCTO	402309001764	402409006664	402409000964	
	EAN	8434035028357	8434035028395	8434035028371	
Verde oscuro	PRODUCTO	402309001791	402409006691	402409000991	
	EAN	8434035028364	8434035028401	8434035028388	

Pres. en madeja

Grosor / Thickness **6 mm** Resistencia / Breaking load **425 kg** Carga trabajo / Work load **127,5 kg**



Carrete

		Código	23 m	50 m	100 m
Camel	PRODUCTO	424410009864	424410001164	424410000964	
	EAN	8434035035843	8434035035737	8434035035706	
Verde oscuro	PRODUCTO	424410009891	424410001191	424410000991	
	EAN	8434035035850	8434035035744	8434035035713	



Cuerda polipropileno 100% trenzada con alma

100% polypropylene double braided rope

► Cuerda PPM trenzada con alma



Carrete

Grosor / Thickness 8 mm	Resistencia / Breaking load 615 kg	Carga trabajo / Work load 184,5 kg
--------------------------------	---	---

Código		25 m	50 m	100 m
Camel	PRODUCTO	424412002264	424412001164	424412000964
	EAN	8434035035959	8434035035898	8434035035867
Verde oscuro	PRODUCTO	424412002291	424412001191	424412000991
	EAN	8434035035966	8434035035904	8434035035874



Carrete

Grosor / Thickness 10 mm	Resistencia / Breaking load 642 kg	Carga trabajo / Work load 192,6 kg
---------------------------------	---	---

Código		25 m	50 m	100 m
Camel	PRODUCTO	428414002264	428414001164	428014000964
	EAN	8434035038837	8434035038769	8434035038035
Verde oscuro	PRODUCTO	428414002291	428414001191	428014000991
	EAN	8434035038844	8434035038776	8434035038066



Carrete

Grosor / Thickness 12 mm	Resistencia / Breaking load 1269 kg	Carga trabajo / Work load 380,7 kg
---------------------------------	--	---

Código		25 m	50 m	100 m
Camel	PRODUCTO	428416002264	428416001164	428016000964
	EAN	8434035038936	8434035038875	8434035038301
Verde oscuro	PRODUCTO	428416002291	428416001191	428016000991
	EAN	8434035038943	8434035038882	8434035038325



Carrete

Grosor / Thickness 14 mm	Resistencia / Breaking load 1800 kg	Carga trabajo / Work load 540 kg
---------------------------------	--	---

Código		25 m	50 m	100 m
Camel	PRODUCTO	428417002264	428417001164	428017000964
	EAN	8434035039032	8434035038974	8434035038547
Verde oscuro	PRODUCTO	428417002291	428417001191	428017000991
	EAN	8434035039049	8434035038981	8434035038578





Cuerdas flame retardant

Flame retardant rope

Las mallas Rombull se fabrican de acuerdo a la NORMA DIN 4102-1. Las mallas Rombull flame retardant cumplen con los requisitos de construcción "schwerentflammbar" (no fácilmente inflamables) de acuerdo con la DIN 4102-1.

Rombull industrial Nets made according to DIN 4102-1. The Rombull flame retardant nets meets the requirements for "schwerentflammbar" (not easily flammable) according to DIN 4102-1.

► Ud. Cuerda flame retardant TR8

Grosor Thick	Metros Meters	Resistencia Resistance	Código Code	Blanco	Negro
4 mm	500 m	270 kg	PRODUCTO	463007001444	463007001466
			EAN	8434035113060	8434035113121
5 mm	500 m	400 kg	PRODUCTO	463009001444	463009001466
			EAN	8434035113077	8434035113282
6 mm	450 m	575 kg	PRODUCTO	463010004244	463010004266
			EAN	8434035113084	8434035113299
8 mm	250 m	1030 kg	PRODUCTO	463012002944	463012002966
			EAN	8434035113091	8434035113305
10 mm	300 m	1630 kg	PRODUCTO	463014003344	463014003366
			EAN	8434035113107	8434035113336
12 mm	200 m	2300 kg	PRODUCTO	463016001044	463016001066
			EAN	8434035113114	8434035113343





Cuerda espiroide

Spiroide rope

- **COMPOSICIÓN:** Polipropileno o poliéster 100% alta tenacidad con tratamiento Anti V, trenzado con alma.
- **CARACTERÍSTICAS:** Fibra suave y flexible, muy ligera, posee flotabilidad con gran resistencia a la tracción, no se deteriora en el agua, resistente a la mayoría de los ácidos.
- **APLICACIONES:** Náutica, juegos infantiles, gimnasia rítmica, toldos, decoración, trabajos manuales, trabajos con poleas, tracción.

- **COMPOSITION:** Composition: 100% high tenacity polypropylene or polyester with UV protection treatment, braided with core.
- **FEATURES:** Soft, flexible, very light fiber, buoyant with a great tensile strength, does not deteriorate in water and resistant to most chemicals.
- **APPLICATIONS:** Navigations, playgrounds, gymnastics, awnings, decorations, crafts, work with pulleys, traction.



► Ud. Carrete cuerda espiroide poliéster (PES)



Carrete

Grosor Thick	Metros Meters	Resistencia Resistance	Carga trabajo Work load	Código Code	Rojo Blanco
6 mm	20 m	438,48 kg	131,54 kg	PRODUCTO	493410001834
				EAN	8434035117662
6 mm	45 m	438,48 kg	131,54 kg	PRODUCTO	493410006634
				EAN	8434035117686
8 mm	10 m	606,20 kg	181,86 kg	PRODUCTO	493412001634
				EAN	8434035117693
8 mm	20 m	606,20 kg	181,86 kg	PRODUCTO	493412001834
				EAN	8434035117709

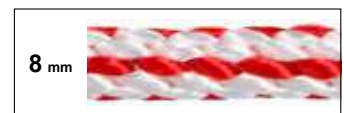



NATURAL NATURAL



GIID
NATURAL
NATURAL

ROMBULL

Cordelería natural

Natural Ropes



Desde sus inicios, Rombull ha sido una empresa comprometida con el cuidado del medio ambiente y su entorno, por lo que aplicamos medidas multidisciplinarias para proteger la biodiversidad, reducir el cambio climático y el uso de recursos productivos y energéticos, a través de nuestro sistema de gestión ambiental, certificado por la norma ISO 14001 o a través de la certificación OEKO-TEX 100, que asegura que el uso de los productos no dejan sustancias nocivas en cantidades superiores a los límites previstos. Por ello, ofrecemos una amplia gama de productos innovadores, fabricados a partir de fibras naturales más ecológicas, sostenibles y respetuosas con la naturaleza, que reducen la contaminación y que detallamos a continuación.

Se llama fibra natural a los fragmentos, hebras o pelo, cuyo origen está en la naturaleza, y que pueden hilarse para dar lugar a hilos o cuerdas. La única fibra natural que es capaz de formar un hilo es la seda; el resto de las fibras se deben teñir e hilar para poder ser utilizadas posteriormente en la fabricación de textiles. Las fibras naturales se clasifican en tres grupos según su origen: vegetal, animal o mineral. Las tres fibras vegetales más importantes son el algodón, el lino y el esparto.

Since its beginning, Rombull has been committed to the protection of the environment. We apply in our production processes multidisciplinary measures to protect the biodiversity, reduce the climate change and improve the use of productive resources and energy. This is achieved through our systems of environmental management, certified according to the ISO 14001 and the Standard 100 by OEKO-TEX 100 (which ensures that the use of products do not leave harmful chemicals above the allowed limits). For this reason, we are offering a new range of products made from natural fibers which are more ecological, sustainable and reduce the environmental impact.

Natural fibers are fragments, strands or hairs with a natural origin that can be spun to create threads and ropes. The only natural fiber that constitutes a thread it-self is silk. All other natural fibers must be spun and dyed in order to be used in the production of textiles. There are three groups: vegetal fibers, animal fibers and mineral fibers. The most important vegetal fibers are: cotton, linen and esparto.



► Lino Linen

La fibra del lino es una fibra vegetal que se obtiene a partir de la planta del lino. El lino es una de las plantas que contiene fibras muy alargadas, ya que estas suelen medir entre los 20 y los 50 cm, aunque se han extraído algunas con una longitud superior al metro. Es una fibra fuerte y flexible, muy resistente y brillante, su elasticidad es menor a la del algodón. Este tipo de fibra junto al yute y cáñamo se les conoce como fibras liberianas. Dado que esta es más suave que las otras dos, es la única que se utiliza para la confección de telas para el hogar. De sus propiedades destacar, la gran absorción a la humedad y el lino no tiene la capacidad de acumular energía estática.

Linen fibers are vegetable fibers obtained from the flax plant. Flax can produce very long fibers with a usual length between 20 and 50 cm, but they can reach occasionally up to a meter. It is a strong and flexible fiber, very resistant and sparkly, but it has less elasticity than cotton. This fiber, together with jute and hemp, is known as a bast fiber, because it is collected from bast, the phloem of the plant, sometimes called the skin. It is the softest material of this group, so that it is the only one used to make home products. Linen is also a high humidity absorbing material and does not accumulate static energy.



► Sisal Sisal

El sisal o henequén, en lengua maya, es una planta utilizada para fines comerciales, cultivada en regiones semiáridas. Se usa principalmente la fibra de las hojas, que se procesan especialmente para fabricar cuerdas, cordeles, sacos, telas y tapetes. La planta es originaria de Yucatán (México). Como el lino y otras agrofibras es la del sisal la base de una industria económicamente importante. La producción anual de la fibra de sisal es la segunda, como agrofibra, después del algodón.

Sisal, or henequen in the Mayan language, is a plant grown in semi-arid regions for commercial purposes. The sisal fibers are obtained mainly from the leaves, they are processed to make ropes, bags, cloths, carpets, etc. The plant is believed to be originally from the Yucatan Peninsula in Mexico. There is a very significant industry behind the production of sisal. It is the second vegetal fiber in production worldwide nowadays, only after the production of cotton.



► Algodón Cotton

El algodón es una fibra textil vegetal que crece alrededor de las semillas de la planta del algodón, un arbusto del género *Gossypium*, perteneciendo a la familia de las malváceas, originario de las regiones tropicales y subtropicales, hay diferentes especies autóctonas en América, África o la India. El algodón es la fibra natural más importante que se produce en el mundo, su importancia comenzó en el siglo XIX con el proceso de industrialización y hoy en día todavía representa casi la mitad del consumo mundial de fibras textiles. No todas las especies del género *Gossypium* tienen valor comercial, las fibras se obtienen de la semilla de unas pocas especies, la longitud y el grueso de la fibra dependen de su procedencia.

Cotton is a textile fiber of vegetal origin that grows around the seeds of the cotton plants of the genus *Gossypium*. It belongs to the Malvaceae family and is native to tropical and sub-tropical regions of the Americas, Africa and India. Cotton is the most important natural fiber in the world according to production. It gained relevance during the Industrial Revolution and it still represents today an approximate 50% of the world's total consumption of natural fibers. Not all the genus *Gossypium* has commercial value. The fibers are obtained from a limited group of species. Their length and thickness depend on their origin.



► Yute Jute

El yute (*Corchorus capsularis*) es una planta herbácea fibrosa, de la familia de las malváceas, cultivada en regiones tropicales por sus fibras. “Yute” es también el nombre de las fibras textiles extraídas de esta planta y de otra similar, *Corchorus olitorius*. Las fibras del yute tienen una longitud de 1 a 4 m y un color blanco amarillento, amarillo o castaño. Se puede blanquear y teñir con facilidad. Es menos resistente y más frágil que el lino y el cáñamo. Es especialmente sensible a los ácidos. Las posibilidades de empleo del yute vienen dadas por sus mismas propiedades. Se hila generalmente en hilos gruesos o medianos y con ellos se tejen arpilleras para sacos, embalajes, cinchas y cordelería.

The *Corchorus capsularis* is a fibrous herbaceous plant that belongs to the malvaceae family. It is cultivated in tropical areas for the value of its fibers. Jute is also the textile fiber obtained from this plant and another similar one called *Corchorus olitorius*. The fibers have usually a length between 1 and 4 m and their color range goes from white to brown. They can be easily whiten or dyed, but are less resistant than linen and hemp fibers. Jute is very sensitive to acids. These properties determine its application. The fibers are spun in threads to produce burlap for sacks, bags, rugs and ropes.



► Coco Coconut

La fibra de coco, es una fibra natural extraída de la cáscara del coco y se utiliza en productos tales como alfombras, felpudos, cepillos y colchones. La fibra de coco se encuentra entre la capa interna dura y la capa exterior de un coco. Otros usos de la fibra de coco son el relleno de tapicería, el saqueo y la horticultura. La fibra blanca de coco, cosechado de cocos verdes, se utiliza para hacer cepillos más finos, hilos, cuerdas y redes de pesca. Las fibras maduras de fibra de coco contienen más lignina y menos celulosa que otras fibras como el lino y el algodón, por lo que son más fuertes pero menos flexibles. Las fibras de coco blanco extraídas de los cocos antes de que maduren son de color blanco o marrón claro y son más suaves y finas, pero también más débiles. En general, se hilan para hacer el hilo utilizado en esteras o cuerdas.

Coir is a natural fiber extracted from the husk of the coconut and is used to produce carpets, mats, brushes and mattresses. Coir is the fibrous material found between the hard, internal shell and the outer coat of a coconut. There are two varieties of coir: brown and white. Brown coir, which is harvested from complete ripened coconuts, is strong, thick and has a high abrasion resistance. Further applications of brown coir are in upholstery padding, sacking and horticulture. On the other hand, white coir, that is harvested from unripe coconuts, is white or has a light brown color. The fibers are smoother and finer, but also weaker. It is used for making finer brushes, ropes, strings and fishing nets.



► Cáñamo Hemp

Cáñamo es el nombre que reciben las variedades de la planta cannabis y el nombre de la fibra que se obtiene de ellas. Es una fibra biodegradable y reciclable. Las aplicaciones más comunes son: fibras textiles (estopa), aceites ricos en omega 3 y proteínas, biocombustibles ecológicos, bioplásticos, bioconstrucción, aplicaciones medicinales, materiales aislantes y piezas plásticas y textiles para automóviles de las marcas Audi y BMW entre otras. El cáñamo se considera la fibra textil de origen vegetal más larga, suave y resistente. También la más aislante, fresca, absorbente y duradera.

Hemp is the name given to a variety of the cannabis sativa plant species and it is also the name of the fiber obtained from it. Hemp is biodegradable and recyclable and among its most common applications are: textile fibers (tow), oils rich in omega-3 and proteins, biofuels, bioplastics, sustainable building, medicine, isolation materials, etc. Companies like Audi and BMW use hemp to produce plastic and textile parts for their cars. Hemp is the longest and most resistant textile fiber of vegetable origin. It is the most isolating, fresh and absorbing fiber and lasts longer.



Hilo lino

Linen thread



- **COMPOSICIÓN:** Hilo lino cableado.
 - **CARACTERÍSTICAS:** Fibra natural, biodegradable, con una buena resistencia y seguridad en el nudo, fibra mas suave que el sisal.
 - **APLICACIONES:** Etiquetas, bricolaje, alimentación, industria, juguetes, textil, jardinería, paquetería, etc.
- **COMPOSITION:** Twisted linen yarn.
 - **FEATURES:** Biodegradable natural fiber, that is softer than sisal. It has a good knot security and strength.
 - **APPLICATIONS:** Labels, DIY, food industry, industry, commerce, toys, textiles, gardening, packaging, etc.

► Ud. Ovillo lino 4/3,5 87 m



Ovillo

Código		
Natural	PRODUCTO	486047008000
	EAN	8434035103849
Verde	PRODUCTO	486047008011
	EAN	8434035103788
Azul	PRODUCTO	486047008022
	EAN	8434035103764
Rojo	PRODUCTO	486047008033
	EAN	8434035103733
Blanco	PRODUCTO	486047008044
	EAN	8434035103825



Ovillo

► Ud. Ovillo lino 4/3,5 175 m

Código		
Natural	PRODUCTO	486047002400
	EAN	8434035103863
Blanco	PRODUCTO	486047002444
	EAN	8434035103870



Hilo pulido

Polished thread



- **COMPOSICIÓN:** Hilo pulido de cáñamo.
- **CARACTERÍSTICAS:** Fibra natural, biodegradable, con una buena resistencia y seguridad en el nudo, fibra más suave que el sisal.
- **APLICACIONES:** Paquetería, bricolaje, industria, comercios, juguetes, tapicerías, agricultura y jardinería.

- **COMPOSITION:** Natural, polished hemp twine.
- **FEATURES:** Biodegradable natural fiber. It is the softest and most resistant natural fiber.
- **APPLICATIONS:** Packaging, DIY, industry, commerce, toys, upholstery, agriculture and gardening.



Descripción Description	Grosor Thick	Metros Meters	Resistencia Resistance
nº 2	1,9 mm	500 m	15,00 kg
nº 4	1,5 mm	1000 m	12,00 kg
nº 5	1,3 mm	1200 m	10,00 kg
nº 6	0,9 mm	1400 m	9,00 kg
nº 8	0,5 mm	1800 m	8,50 kg
nº 10	0,4 mm	2000 m	7,00 kg
nº 12	0,3 mm	2900 m	5,00 kg

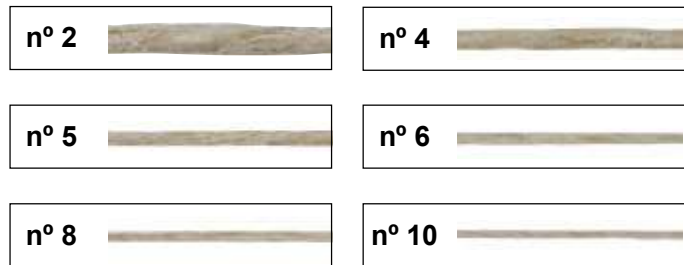

► Pack 10 unidades. Hilo pulido



Ovillo

	Código	50 g	100 g
nº 2	PRODUCTO	454600005300	454600005400
	EAN	8434035149830	8434035149687
nº 4	PRODUCTO	454600005600	454600005700
	EAN	8434035149694	8434035149700
nº 5	PRODUCTO	454600004200	454600004700
	EAN	8434035149717	8434035149724
nº 6	PRODUCTO	454600004300	454600004800
	EAN	8434035149731	8434035149748
nº 8	PRODUCTO	454600004400	454600004900
	EAN	8434035149755	8434035149762
nº 10	PRODUCTO	454600004500	454600005800
	EAN	8434035149793	8434035149809
nº 12	PRODUCTO	454600004600	454600006800
	EAN	8434035149816	8434035149823



Presentación en pack 10 unidades
Presentation on pack of 10 units

► Ud. Hilo pulido



Bobina

	Código	50 g	100 g
nº 2	PRODUCTO	454300005300	454300005400
	EAN	8434035047860	8434035047877
nº 4	PRODUCTO	454300005600	454300005700
	EAN	8434035047884	8434035047891
nº 5	PRODUCTO	454300004200	454300004700
	EAN	8434035047761	8434035047822
nº 6	PRODUCTO	454300004300	454300004800
	EAN	8434035047778	8434035047839
nº 8	PRODUCTO	454300004400	454300004900
	EAN	8434035047785	8434035047846
nº 10	PRODUCTO	454300004500	454300005800
	EAN	8434035047808	8434035047907
nº 12	PRODUCTO	454300004600	454300006800
	EAN	8434035047815	8434035047914



Hilo sisal

Sisal thread



- **COMPOSICIÓN:** Hilo sisal de varios grosores, torcido a diferentes cabos.
- **COMPOSITION:** Sisal yarn of various thicknesses, twisted in different strands.
- **CARACTERÍSTICAS:** Fibra natural, biodegradable, con una buena resistencia y seguridad en el nudo, no posee elasticidad.
- **FEATURES:** Biodegradable natural fiber with great resistance and knot security, no elasticity.
- **APLICACIONES:** Decoración, minería, mudanzas, pocería, escenografías.
- **APPLICATIONS:** Decoration, mining, removals, shafts, scenery.



Ovillo

Ud. Ovillo sisal 800/2

Grosor Thick	Metros Meters	Peso Weight	Código Producto Product code	Código EAN EAN Code
2,5 mm	40 m	50 g	446002007100	8434035111608
2,5 mm	80 m	100 g	446002008000	8434035111585



Ovillo

Ud. Ovillo sisal 600/2

Grosor Thick	Metros Meters	Peso Weight	Código Producto Product code	Código EAN EAN Code
2,5 mm	60 m	100 g	446003008000	8434035111660



Ovillo

Ud. Ovillo sisal 600/3

Grosor Thick	Metros Meters	Peso Weight	Código Producto Product code	Código EAN EAN Code
3,5 mm	60 m	100 g	447005008000	8434035111622
3,5 mm	150 m	250 g	447105005100	8434035111639



Bobina

Ud. Bobina sisal 1 a 2c

244 m/kg	Grosor / Thickness 2,5 mm	Resistencia / Breaking load 70 kg	Carga trabajo / Work load 21 kg
Código 200 g			
1 a 2C	PRODUCTO	464000002400	
	EAN	8434035049956	



Bobina

Ud. Bobina sisal 3/4 a 1c

390 m/kg	Grosor / Thickness 2 mm	Resistencia / Breaking load 50 kg	Carga trabajo / Work load 15 kg
Código 400 g		700 g	
3/4 a 1C	PRODUCTO	445000002500	445000002700
	EAN	8434035045828	8434035045835



Bobina

Ud. Bobina sisal 3/4 a 2c

195 m/kg	Grosor / Thickness 3 mm	Resistencia / Breaking load 87 kg	Carga trabajo / Work load 26,1 kg
Código 120 g		400 g	700 g
3/4 a 2C	PRODUCTO	446000003800	446000002500
	EAN	8434035045903	8434035045866
		446000002700	446000003500
		8434035045880	8434035045897



Bobina

Ud. Bobina sisal 3/4 a 3c

130 m/kg	Grosor / Thickness 3,5 mm	Resistencia / Breaking load 131 kg	Carga trabajo / Work load 39,3 kg
Código 130 m - 400 g		130 m - 700 g	130 m - 2500 g
3/4 a 3C	PRODUCTO	447000002500	447000002700
	EAN	8434035045965	8434035045989
		447000003500	8434035045996



Cuerda cableada sisal

Twisted sisal rope



- **COMPOSICIÓN:** Sisal cableado a 4 cabos.
- **CARACTERÍSTICAS:** Fibra natural, biodegradable, con una buena resistencia y seguridad en el nudo, no posee elasticidad.
- **APLICACIONES:** Usos múltiples en agricultura, pesca y ganadería. Comercio, industria, transporte, trabajos manuales, bricolaje, remolques, decoración, alimentación.

- **COMPOSITION:** 4-strand cabled sisal rope.
- **FEATURES:** Biodegradable natural fiber with great resistance and knot security, no elasticity.
- **APPLICATIONS:** Multiple use in agriculture, fisheries, animal husbandry, commerce, industry, transport, crafts, DIY, trailers, decoration, food.

► Ud. Cuerda cableada sisal 4c



Rollo

Grosor Thick	Metros Meters	Peso Weight	Resistencia Resistance	Código Producto Product code	Código EAN EAN Code
6 mm	200 m	5,90 kg	255 kg	437010001000	8434035043053
8 mm	100 m	4,80 kg	473 kg	437012000900	8434035043121
10 mm	100 m	6,10 kg	622 kg	437014000900	8434035043213
12 mm	100 m	9,50 kg	936 kg	437016000900	8434035043312
14 mm	100 m	12,60 kg	1.260 kg	437017000900	8434035043381
16 mm	100 m	17,10 kg	1.770 kg	437018000900	8434035043459
18 mm	100 m	19,80 kg	2.100 kg	437019000900	8434035043527
20 mm	100 m	24,80 kg	2.790 kg	437020000900	8434035043596



12 mm

► Ud. Carrete cuerda cableada sisal 4c

Código		5 m	10 m	15 m	20 m	25 m	50 m
6 mm	PRODUCTO	437010003700	437010001600	437410001700	437410001800	437410002200	437410001100
	EAN	8434035043114	8434035043077	8434035043787	8434035043794	8434035043800	8434035043763
Presentación en madeja							

Código		5 m	10 m	15 m	20 m	25 m	50 m
8 mm	PRODUCTO	437012003700	437412001600	437412001700	437412001800	437412002200	437412001100
	EAN	8434035043190	8434035043831	8434035043848	8434035043855	8434035043862	8434035043824
Pres. en madeja							

Código		5 m	10 m	15 m	20 m	25 m	50 m
10 mm	PRODUCTO	437414003700	437414001600	437414001700	437414001800	437414002200	437414001100
	EAN	8434035043930	8434035043893	8434035043909	8434035043916	8434035043923	8434035043886

Código		5 m	10 m	15 m	20 m	25 m	50 m
12 mm	PRODUCTO	437416003700	437416001600	437416001700	437416001800	437416002200	437416001100
	EAN	8434035043992	8434035043954	8434035043961	8434035043978	8434035043985	8434035043947

Código		5 m	10 m	15 m	20 m	25 m	50 m
14 mm	PRODUCTO	437417003700	437417001600	437417001700	437417001800	437417002200	437417001100
	EAN	8434035044050	8434035044012	8434035044029	8434035044036	8434035044043	8434035044005

Código		5 m	10 m	15 m	20 m	25 m	50 m
16 mm	PRODUCTO	437418003700	437418001600	437418001700	437418001800	437418002200	437418001100
	EAN	8434035044111	8434035044074	8434035044081	8434035044098	8434035044104	8434035044067



Carrete



Carrete



Carrete

Hilo algodón natural

Natural cotton thread

Página 85 Tarifa. Page 85 Price List.



- **COMPOSICIÓN:** Hilo de algodón 100% natural cableado.
- **CARACTERÍSTICAS:** Fibra natural, biodegradable, buena elasticidad y resistencia al desgaste. Tacto suave y fácil anudabilidad.
- **APLICACIONES:** Alimentación, industria, trabajos manuales, juguetes, textil, agricultura, jardinería, bricolaje.

- **COMPOSITION:** 100% natural cotton cabled.
- **FEATURES:** Biodegradable natural fiber with good elasticity and abrasion resistance. Soft touch and easy knotting
- **APPLICATIONS:** Food industry, industry, crafts, toys, textiles, agriculture, gardening and DIY.



Bobina

► Ud. Hilo algodón 100% cableado 70m

	Código	70 m - 55 g
Natural	PRODUCTO	462099004400
	EAN	8434035113909



Ovillo

► Ud. Hilo algodón 100% cableado 70m

	Código	70 m - 55 g
Natural	PRODUCTO	462399004400
	EAN	8434035113916



Madeja

► Md. Cuerda 5mm trenzada algodón 100%

Grosor Thick	Metros Meters	Peso Weight	Código Producto Product code	Código EAN EAN Code
5 mm	15 m	155 g	407309001744	8434035117051



Carrete

► Ud. Carrete cuerda 5mm trenzada algodón 100%

Grosor Thick	Metros Meters	Peso Weight	Código Producto Product code	Código EAN EAN Code
5 mm	25 m	318 g	407409002244	8434035117068
5 mm	60 m	625 g	407109005244	8434035117075

Cuerda algodón natural

Natural cotton rope

Página 85 Tarifa. Page 85 Price List.



- **COMPOSICIÓN:** Algodón 100% natural cableado.
- **CARACTERÍSTICAS:** Fibra natural, biodegradable, buena elasticidad y resistencia al desgaste. Tacto suave y fácil anudabilidad.
- **APLICACIONES:** Trabajos manuales, juguetes, textil, agricultura, ganadería, jardinería, bricolaje, mudanzas, transportes, toldos.

- **COMPOSITION:** 100% natural cotton cabled.
- **FEATURES:** Biodegradable natural fiber with good elasticity and abrasion resistance. Soft touch and easy knotting.
- **APPLICATIONS:** Crafts, toys, textile industry, agriculture, cattle raising, gardening, DIY, removals, transport and awnings.



Carrete

► Ud. Carrete cuerda 4mm cableada algodón 100%

Grosor Thick	Metros Meters	Peso Weight	Código Producto Product code	Código EAN EAN Code
4 mm	25 m	430 g	408407002244	8434035116412
4 mm	55 m	800 g	408107005244	8434035116429



Carrete

► Ud. Carrete cuerda 6mm cableada algodón 100%

Grosor Thick	Metros Meters	Peso Weight	Código Producto Product code	Código EAN EAN Code
6 mm	15 m	410 g	408410001744	8434035116481
6 mm	25 m	756 g	408410002244	8434035116498
6 mm	50 m	1270 g	408410001144	8434035116504



Carrete

► Ud. Carrete cuerda 8mm cableada algodón 100%

Grosor Thick	Metros Meters	Peso Weight	Código Producto Product code	Código EAN EAN Code
8 mm	10 m	460 g	408412001644	8434035116511
8 mm	20 m	760 g	408412001844	8434035117020
8 mm	30 m	1070 g	408412001944	8434035117037



Cuerda yute

Jute rope



• COMPOSICIÓN: Fibra de yute 100% natural.
• CARACTERÍSTICAS: Biodegradable, alta tenacidad y gran anudabilidad.
• APLICACIONES: Decoración, industria textil, pesca, agricultura.

• COMPOSITION: 100% natural jute fibers.
• FEATURES: Biodegradable, high tenacity, soft touch rope with excellent knotting properties.
• APPLICATIONS: Decoration, textile industry, fishing and agriculture.



Bobina

► Heavy duty jute twine 50m

	Código	50 m - 100 g	
Natural	PRODUCTO	486052001100	
	EAN	8434035113879	

	Código	50 m - 100 g	
Verde	PRODUCTO	486052001111	
	EAN	8434035113886	



Bobina

► Light duty jute twine 60m

	Código	60 m - 100 g	
Natural	PRODUCTO	486051006700	
	EAN	8434035113848	

	Código	60 m - 100 g	
Verde	PRODUCTO	486051006711	
	EAN	8434035113855	



Madeja

► Md. Yute cableada 6mm/10m

	Código	10 m - 100 g	
Natural	PRODUCTO	486010001600	
	EAN	8434035112520	



Rollo

► Rollo yute cableado 8mm/10m

	Código	10 m - 100 g	
Natural	PRODUCTO	486012001600	
	EAN	8434035112537	



Rollo

► Rollo yute cableado 10mm/10m

	Código	10 m - 100 g	
Natural	PRODUCTO	486014001600	
	EAN	8434035112544	



Rollo

► Rollo yute cableado 12mm/15m

	Código	15 m - 100 g	
Natural	PRODUCTO	486016001700	
	EAN	8434035114760	





NATURAL
NATURAL

Cuerda cableada cáñamo

Twisted hemp rope



- **COMPOSICIÓN:** Cáñamo cableado a 4 cabos.
 - **CARACTERÍSTICAS:** Fibra natural, biodegradable, con una buena resistencia y seguridad en el nudo, fibra mas suave que el sisal.
 - **APLICACIONES:** Decoración, minería, mudanzas, poceria, escenografías.
- **COMPOSITION:** 4 strand cabled twisted hemp.
 - **FEATURES:** Biodegradable natural fiber softer than sisal with a good knot security and strength.
 - **APPLICATIONS:** Decoration, mining, removals, shafts and scenography.



Rollo

► Ud. Cuerda cableada cáñamo 4c



Grosor Thick	Metros Meters	Peso Weight	Código Producto Product code	Código EAN EAN Code
6 mm	200 m	6,00 kg	456010001000	8434035048140
8 mm	100 m	5,20 kg	456012000900	8434035048201
10 mm	100 m	6,90 kg	456014000900	8434035048225
12 mm	100 m	10,50 kg	456016000900	8434035048232
14 mm	100 m	12,50 kg	456017000900	8434035048249



NATURAL
NATURAL

MALLAS SOMBREO Y OCULTACIÓN

SHADE NETS

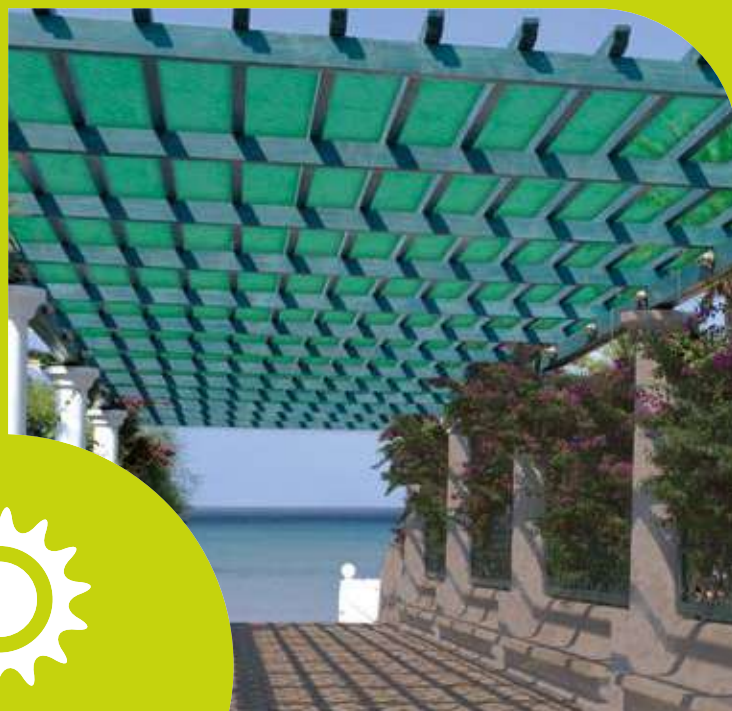

Malla sombreo 40%, 50% y 60%

Shade nets 40%, 50% & 60%

Malla sombreo/ocultación con un porcentaje del 40%, 50% y 60%, producida en sistema raschel, producto indesmallable, compuesto de monofilamento de alta densidad HDPE, y cinta de rafia de polietileno. Facilita la intimidad en los trabajos exteriores. Se puede adaptar a la medida que se necesite por su fácil corte, tejido muy resistente al deshilachado. Con tratamiento UV para protección 2 años. Malla fabricada en España.

Shade/hidden net with a percentage of 40%, 50% & 60%, produced in raschel system, unraveling product, made from high density PE monofilaments and polyethylene tape raffia. Prevents workers from being seen and protects their privacy from outsiders. Being a very easy to cut textile, can be adapted to any size; very resistant to unraveling. Treated against UV for 2 years. Made in Spain.

Protección anti UV UV protected 

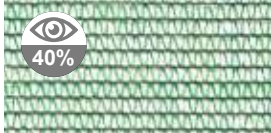

► M² Malla sombreo PE/RF 40%

Verde claro	Blanco	Negro	Verde oscuro
505291201611	505291201644	505291201666	505291201691

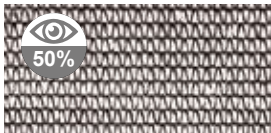

► M² Malla sombreo PE/RF 50%

Verde claro	Blanco	Negro	Verde oscuro
505292101611	505292101644	505292101666	505292101691



► M² Malla sombreo PE/RF 60%

Verde claro	Blanco	Negro	Verde oscuro
505292201611	505292201644	505292201666	505292201691

Otros colores y medidas consultar disponibilidades y cantidades mínimas.

Other colors and sizes check availability and minimum quantities.



Malla sombreo 70%

Shade nets 70%

Malla sombreo/ocultación del 70%, producida en sistema raschel, producto indesmallable, compuesto de monofilamento de alta densidad HDPE, y cinta de rafia de polietileno. Facilita la intimidad en los trabajos exteriores. Adaptable a la medida que se necesite por su fácil corte, tejido muy resistente al deshilachado. Tratamiento UV para protección 2 años. Fabricada en España.

Shade/hidden net of 70%, produced in raschel system, unraveling product, made from high density PE monofilaments and polyethylene tape raffia. Prevents workers from being seen and protects their privacy from outsiders. Being a very easy to cut textile, it can be adapted to any size; very resistant to unraveling. Treated against UV for 2 years. Made in Spain.

Protección anti UV UV protected 

► Ud. Malla sombreo PE/RF 70%

	Código	1 x 50	1,50 x 50	2 x 50	1 x 100	1,50 x 100	2 x 100	3 x 100	4 x 100
Verde claro	PRODUCTO	505291303611	505291304611	505291305611	505291308611	505291309611	505291310611	505291311611	505291312611
	EAN	8434035058224	8434035058330	8434035058446	8434035058743	8434035058842	8434035058941	8434035059092	8434035059191
Blanco	PRODUCTO	505291303644	505291304644	505291305644	505291308644	505291309644	505291310644	505291311644	505291312644
	EAN	8434035058255	8434035058378	8434035058507	8434035058774	8434035058880	8434035059009	8434035059122	8434035059252
Marrón brezo	PRODUCTO	505291303664	505291304664	505291305664	505291308664	505291309664	505291310664	-	-
	EAN	8434035058286	8434035058392	8434035058538	8434035058804	8434035058903	8434035059030	-	-
Negro	PRODUCTO	505291303666	505291304666	505291305666	505291308666	505291309666	505291310666	505291311666	505291312666
	EAN	8434035058293	8434035058408	8434035058545	8434035058811	8434035058910	8434035059047	8434035059153	8434035059283
Verde oscuro	PRODUCTO	505291303691	505291304691	505291305691	505291308691	505291309691	505291310691	505291311691	505291312691
	EAN	8434035058309	8434035058415	8434035058552	8434035058828	8434035058927	8434035059061	8434035059160	8434035059290

► M². Malla sombreo PE/RF 70%

Verde claro	Azul	Rojo	Blanco	Marrón brezo	Negro	Verde oscuro	Marrón caña
505291301611	505291301622	505291301633	505291301644	505291301664	505291301666	505291301691	505291301603

► Ud. Minirrollo ocultación PE/RF 70%

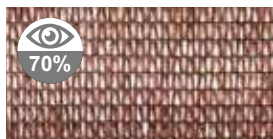
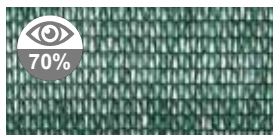

	Código	1 x 5	1 x 10	1,50 x 5	1,50 x 10	2 x 5	2 x 10
Verde claro	PRODUCTO	505291323611	505291317611	505291329611	505291318611	505291314611	505291319611
	EAN	8434035059696	8434035059504	8434035059757	8434035059566	8434035059320	8434035059627
Negro	PRODUCTO	505291323666	505291317666	505291329666	505291318666	505291314666	505291319666
	EAN	8434035059726	8434035059535	8434035059788	8434035059597	8434035059351	8434035059665
Verde oscuro	PRODUCTO	505291323691	505291317691	505291329691	505291318691	505291314691	505291319691
	EAN	8434035059733	8434035059542	8434035059795	8434035059603	8434035059368	8434035059672
Blanco	PRODUCTO	505291323644	505291317644	505291329644	505291318644	505291314644	505291319644
	EAN	8434035059702	8434035059511	8434035059764	8434035059573	8434035059337	8434035059641
Marrón brezo	PRODUCTO	505291323664	505291317664	505291329664	505291318664	505291314664	505291319664
	EAN	8434035059719	8434035059528	8434035059771	8434035059580	8434035059344	8434035059658

► Ud. Minirrollo sombreo PE/RF 70%



	Código	3 x 4	4 x 5	4 x 8
Verde claro	PRODUCTO	505291315611	505291316611	505291333611
	EAN	8434035059382	8434035059443	8434035059849
Negro	PRODUCTO	505291315666	505291316666	505291333666
	EAN	8434035059412	8434035059474	8434035059870
Verde oscuro	PRODUCTO	505291315691	505291316691	505291333691
	EAN	8434035059429	8434035059481	8434035059887
Blanco	PRODUCTO	505291315644	505291316644	505291333644
	EAN	8434035059399	8434035059467	8434035059863
Marrón brezo	PRODUCTO	505291315664	505291316664	505291333664
	EAN	8434035059405	8434035059467	8434035059863



Malla ocultación 80%

Shade nets 80%

Malla sombreado/ocultación con un porcentaje del 80%, producida en sistema raschel, producto indesmallable, compuesto de monofilamento de alta densidad HDPE, y cinta de rafia de polietileno. Facilita la intimidad en los trabajos exteriores. Se puede adaptar a la medida que se necesite por su fácil corte, tejido muy resistente al deshilachado. Con tratamiento UV para protección 2 años. Malla fabricada en España.

Shade/hidden net with a percentage of 80%, produced in raschel system, unraveling product, made from high density PE monofilaments and polyethylene tape raffia. Prevents workers from being seen, and protects their privacy from outsiders. Being a very easy to cut textile, it can be adapted to any size; very resistant to unraveling. Treated against UV for 2 years. Made in Spain.

Protección anti UV UV protected 

► Ud. Malla ocultación PE/RF 80%

	Código	1 x 50	1,50 x 50	2 x 50	1 x 100	1,50 x 100	2 x 100	3 x 100	4 x 100
Verde claro	PRODUCTO	505291403611	505291404611	505291405611	505291408611	505291409611	505291410611	505291411611	505291412611
	EAN	8434035060142	8434035060203	8434035060265	8434035060470	8434035060531	8434035060593	8434035060722	8434035060784
Blanco	PRODUCTO	505291403644	505291404644	505291405644	505291408644	505291409644	505291410644	505291411644	505291412644
	EAN	8434035060159	8434035060210	8434035060296	8434035060487	8434035060548	8434035060630	8434035060739	8434035060807
Marrón brezo	PRODUCTO	505291403664	505291404664	505291405664	505291408664	505291409664	505291410664	-	-
	EAN	8434035060166	8434035060227	8434035060319	8434035060494	8434035060555	8434035060661	-	-
Negro	PRODUCTO	505291403666	505291404666	505291405666	505291408666	505291409666	505291410666	505291411666	505291412666
	EAN	8434035060173	8434035060234	8434035060326	8434035060500	8434035060562	8434035060678	8434035060753	8434035060821
Verde oscuro	PRODUCTO	505291403691	505291404691	505291405691	505291408691	505291409691	505291410691	505291411691	505291412691
	EAN	8434035060180	8434035060241	8434035060333	8434035060517	8434035060579	8434035060685	8434035060760	8434035060838

► M² Malla ocultación PE/RF 80%

Verde claro	Blanco	Marrón brezo	Negro	Verde oscuro	Marrón caña
505291401611	505291401644	505291401664	505291401666	505291401691	505291401603

► Ud. Minirrollo ocultación PE/RF 80%

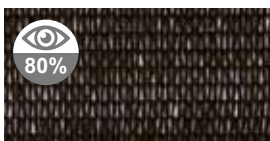
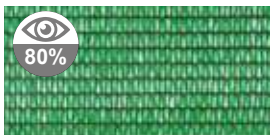

	Código	1 x 5	1 x 10	1,50 x 5	1,50 x 10	2 x 5	2 x 10
Verde claro	PRODUCTO	505291423611	505291417611	505291429611	505291418611	505291414611	505291419611
	EAN	8434035061224	8434035061033	8434035061309	8434035061095	8434035060852	8434035061156
Negro	PRODUCTO	505291423666	505291417666	505291429666	505291418666	505291414666	505291419666
	EAN	8434035061255	8434035061064	8434035061330	8434035061125	8434035060883	8434035061187
Verde oscuro	PRODUCTO	505291423691	505291417691	505291429691	505291418691	505291414691	505291419691
	EAN	8434035061262	8434035061071	8434035061347	8434035061132	8434035060890	8434035061194
Marrón brezo	PRODUCTO	505291423664	505291417664	505291429664	505291418664	505291414664	505291419664
	EAN	8434035061248	8434035061057	8434035061323	8434035061118	8434035060876	8434035061170

► Ud. Minirrollo sombreado PE/RF 80%



	Código	3 x 4	4 x 5	4 x 8
Verde claro	PRODUCTO	505291415611	505291416611	505291433611
	EAN	8434035060913	8434035060975	8434035061408
Negro	PRODUCTO	505291415666	505291416666	505291433666
	EAN	8434035060944	8434035061002	8434035061439
Verde oscuro	PRODUCTO	505291415691	505291416691	505291433691
	EAN	8434035060951	8434035061019	8434035061446
Marrón brezo	PRODUCTO	505291415664	505291416664	505291433664
	EAN	8434035060937	8434035060999	8434035061422



Malla ocultación 90%

Shade nets 90%

Malla sombreado producida en sistema raschel indesmallable, compuesta de monofilamento de alta densidad HDPE y cinta de rafia de polietileno. Facilita la intimidad en los trabajos exteriores, de fácil colocación gracias a la doble botonera superior e inferior, adaptándose a la medida que se necesite por su fácil corte, tejido muy resistente al deshilachado. Con tratamiento UV para protección 2 años. Malla fabricada en España.

Shade net produced in raschel system unraveling material, made from polyethylene high density monofilament HDPE and polyethylene raffia tape. Prevents workers from being seen from outside and protects their privacy, easy to install thanks to it's double-touch pad on top and bottom part. Easy to cut, can be adapted to the required size, very resistant to unraveling. Treated against UV for 2 years. Made in Spain.

Protección anti UV UV protected 

► Ud. Malla ocultación PE/RF 90%

	Código	1 x 50	1,50 x 50	2 x 50	1 x 100	1,50 x 100	2 x 100	3 x 100	4 x 100
Verde claro	PRODUCTO	505291503611	505291504611	505291505611	505291508611	505291509611	505291510611	505291511611	505291512611
	EAN	8434035061651	8434035061712	8434035061781	8434035061958	8434035062016	8434035062078	8434035062153	8434035062214
Blanco	PRODUCTO	505291503644	505291504644	505291505644	505291508644	505291509644	505291510644	505291511644	505291512644
	EAN	8434035061668	8434035061729	8434035061804	8434035061965	8434035062023	8434035062092	8434035062160	8434035062238
Marrón brezo	PRODUCTO	505291503664	505291504664	505291505664	505291508664	505291509664	505291510664	505291511664	505291512664
	EAN	8434035061675	8434035061736	8434035061811	8434035061972	8434035062030	8434035062115	8434035062177	8434035062245
Negro	PRODUCTO	505291503666	505291504666	505291505666	505291508666	505291509666	505291510666	505291511666	505291512666
	EAN	8434035061682	8434035061743	8434035061828	8434035061989	8434035062047	8434035062122	8434035062184	8434035062252
Verde oscuro	PRODUCTO	505291503691	505291504691	505291505691	505291508691	505291509691	505291510691	505291511691	505291512691
	EAN	8434035061699	8434035061750	8434035061835	8434035061996	8434035062054	8434035062139	8434035062191	8434035062269
Marrón caña	PRODUCTO	505291503603	505291504603	505291505603	505291508603	505291509603	505291510603	505291511603	505291512603
	EAN	8434035061644	8434035061705	8434035061774	8434035061941	8434035062009	8434035062061	8434035062146	8434035062207

► M² Malla ocultación PE/RF 90%

Verde claro	Blanco	Marrón brezo	Negro	Verde oscuro	Marrón caña
505291501611	505291501644	505291501664	505291501666	505291501691	505291501603

► Ud. Minirrollo ocultación PE/RF 90%



	Código	1 x 5	1 x 10	1,50 x 5	1,50 x 10	2 x 5	2 x 10
Verde claro	PRODUCTO	505291523611	505291517611	505291529611	505291518611	505291514611	505291519611
	EAN	8434035062658	8434035062443	8434035062733	8434035062504	8434035062283	8434035062566
Negro	PRODUCTO	505291523666	505291517666	505291529666	505291518666	505291514666	505291519666
	EAN	8434035062689	8434035062474	8434035062764	8434035062535	8434035062313	8434035062597
Verde oscuro	PRODUCTO	505291523691	505291517691	505291529691	505291518691	505291514691	505291519691
	EAN	8434035062696	8434035062481	8434035062771	8434035062542	8434035062320	8434035062603
Blanco	PRODUCTO	505291523644	505291517644	505291529644	505291518644	505291514644	505291519644
	EAN	8434035062665	8434035062450	8434035062740	8434035062511	8434035062290	8434035062573
Marrón brezo	PRODUCTO	505291523664	505291517664	505291529664	505291518664	505291514664	505291519664
	EAN	8434035062672	8434035062467	8434035062757	8434035062528	8434035062306	8434035062580
Marrón caña	PRODUCTO	505291523603	505291517603	505291529603	505291518603	505291514603	505291519603
	EAN	8434035062641	8434035062436	8434035062726	8434035062498	8434035062276	8434035062559

Pieza plástica

Plastic piece

► Ud. Clip fijación mallas



10 unidades	100 unidades
524000003066	524000004066

Página 90 Tarifa. Page 90 Price List.



Malla garden plus

Garden nets plus

Malla sombreo producida en sistema raschel indesmallable, compuesta de monofilamento de alta densidad HDPE y cinta de rafia de polietileno. Facilita la intimidad en los trabajos exteriores, de fácil colocación gracias a la doble botonera superior e inferior, adaptándose a la medida que se necesite por su fácil corte, tejido muy resistente al deshilachado. Con tratamiento UV para protección 2 años. Malla fabricada en España.

Shade net produced in raschel system unraveling material, made from polyethylene high density monofilament HDPE and polyethylene raffia tape. Prevents workers from being seen from outside and protects their privacy, easy to install thanks to it's double-touch pad on top and bottom part. Easy to cut, can be adapted to the required size, very resistant to unraveling. Treated against UV for 2 years. Made in Spain.

Protección anti UV UV protected 

► Ud. Malla garden plus

	Código	1 x 50	1,50 x 50	2 x 50	1 x 100	1,50 x 100	2 x 100	3 x 100
Verde claro	PRODUCTO	517291303611	517291304611	517291305611	517291308611	517291309611	517291310611	517291310611
	EAN	8434035065246	8434035065284	8434035065321	8434035065390	8434035065420	8434035065451	8434035065482
Marrón brezo	PRODUCTO	517291303664	517291304664	517291305664	517291308664	517291309664	517291310664	517291310664
	EAN	8434035065253	8434035065291	8434035065338	8434035065406	8434035065437	8434035065468	8434035065499
Verde oscuro	PRODUCTO	517291303691	517291304691	517291305691	517291308691	517291309691	517291310691	517291310691
	EAN	8434035065277	8434035065314	8434035065352	8434035065413	8434035065444	8434035065475	8434035065505

► M² Malla garden plus

Verde claro	Marrón brezo	Verde oscuro
517291301611	517291301664	517291301691

► Ud. Minirrollo garden plus



	Código	1 x 5	1 x 10	1,50 x 5	1,50 x 10	2 x 5	2 x 10
Verde claro	PRODUCTO	517291323611	517291317611	517291329611	517291318611	517291314611	517291319611
	EAN	8434035065734	8434035065611	8434035065772	8434035065659	8434035065512	8434035065697
Marrón brezo	PRODUCTO	517291323664	517291317664	517291329664	517291318664	517291314664	517291319664
	EAN	8434035065741	8434035065628	8434035065789	8434035065666	8434035065529	8434035065703
Verde oscuro	PRODUCTO	517291323691	517291317691	517291329691	517291318691	517291314691	517291319691
	EAN	8434035065765	8434035065642	8434035065802	8434035065680	8434035065543	8434035065727



Malla flame retardant

Flame retardant nets

Las mallas Rombull se fabrican de acuerdo a la NORMA DIN 4102-1. Las mallas Rombull flame retardant cumplen con los requisitos de construcción "schwerentflammbar" (no fácilmente inflamables) de acuerdo con la DIN 4102-1, si se utilizan suspendidos libremente o a una distancia superior a 40 mm de separación de otros materiales.

Rombull industrial nets made according to DIN 4102-1. The Rombull flame retardant nets meets the requirements for "schwerentflammbar" (not easily flammable) according to DIN 4102-1, if used suspended freely or with distance of > 40mm to the same or other plain materials.

► Ud. Malla flame retardant 90%

	Código	2x50	2x100
Negro	PRODUCTO	505294005666	505294010666
	EAN	8434035113701	8434035113718



Malla sombreo bicolor 70% y 80%

Bicolor shade nets 70% and 80%

Página 91 Tarifa. Page 91 Price List.

Malla de ocultación para valla móvil, fabricada en sistema raschel, facilita la privacidad en los trabajos exteriores. Protección solar, franjas horizontales en color 1,9 m de altura para evitar los soportes inferiores de vallas.

Hidden mesh for mobile fence, manufactured in raschel system machine, protects workers privacy from outsiders. Protected against UV, color horizontal fringes 1,9 m high to avoid covering the bottom support from the mobile fence.

Protección anti UV UV protected 

► Ud. Malla sombreo PE/RF 70%

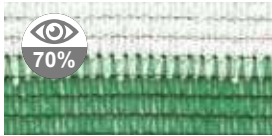

		Código	2x50	2x100
Verde/ Blanco	PRODUCTO		505291305614	505291310614
	EAN		8434035058453	8434035058958
Azul/ Blanco	PRODUCTO		505291305624	505291310624
	EAN		8434035058477	8434035058972
Amarillo/ Negro	PRODUCTO		505291305656	505291310656
	EAN		8434035058521	8434035059023

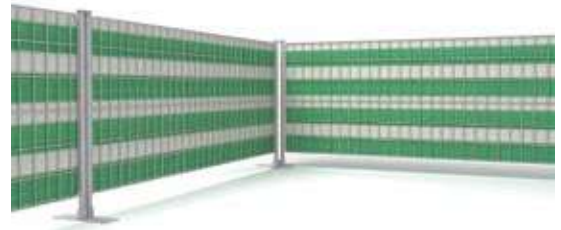

Otros colores y medidas consultar disponibilidades y cantidades mínimas.
Other colors and sizes check availability and minimum quantities.

► Ud. Malla ocultación PE/RF 80%



		Código	2x50	2x100
Verde/ Blanco	PRODUCTO		505291405614	505291410614
	EAN		8434035060272	8434035060609
Azul/ Blanco	PRODUCTO		505291405624	505291410624
	EAN		8434035060289	8434035060616
Amarillo/ Negro	PRODUCTO		505291405656	505291410656
	EAN		8434035060302	8434035060654



Malla ocultación bicolor 90%

Bicolor shade nets 90%

Página 92 Tarifa. Page 92 Price List.

Malla de ocultación para valla móvil, fabricada en sistema raschel, facilita la privacidad en los trabajos exteriores. Protección solar, franjas horizontales en color 1,9 m de altura para evitar los soportes inferiores de vallas.

Hidden mesh for mobile fence, manufactured in raschel system machine, protects workers privacy from outsiders. Protected against UV, color horizontal fringes 1,9 m high to avoid covering the bottom support from the mobile fence.

Protección anti UV UV protected 

► Ud. Malla ocultación PE/RF 90%

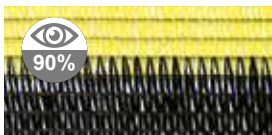

		Código	1,90 x 3,60	1,90 x 50
Amarillo/ Negro	PRODUCTO		505291520656	505291521656
	EAN		8434035062610	8434035062627



Malla sombreo 70%, construcción 90% y señalización

Shade nets 70%, construction nets 90% & signaling

Página 92 Tarifa. Page 92 Price List.

Malla de ocultación, fabricada en sistema raschel, facilita la privacidad en los trabajos exteriores. Protección solar.
Hide mesh for mobile fence, manufactured in raschel system machine, protects workers privacy from outsiders.

Antirrayos UV Anti-rays UV 

► Ud. Malla sombreo PE/RF 70%

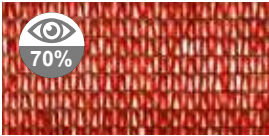

		Código	1 x 50	2 x 50	1 x 100	2 x 100
Azul	PRODUCTO		505291303622	505291305622	505291308622	505291310622
	EAN		8434035058231	8434035058460	8434035058750	8434035058965
Rojo	PRODUCTO		505291303633	505291305633	505291308633	505291310633
	EAN		8434035058248	8434035058491	8434035058767	8434035058996

► Ud. Malla ocultación PE/RF 90% FM

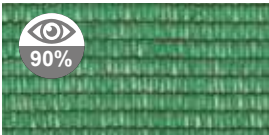

		Código	2x50	2x100
Verde claro	PRODUCTO		505292305611	505292310611
	EAN		8434035063105	8434035063181
Negro	PRODUCTO		505292305666	505292310666
	EAN		8434035063129	8434035063228
Verde oscuro	PRODUCTO		505292305691	505292310691
	EAN		8434035063136	8434035063235

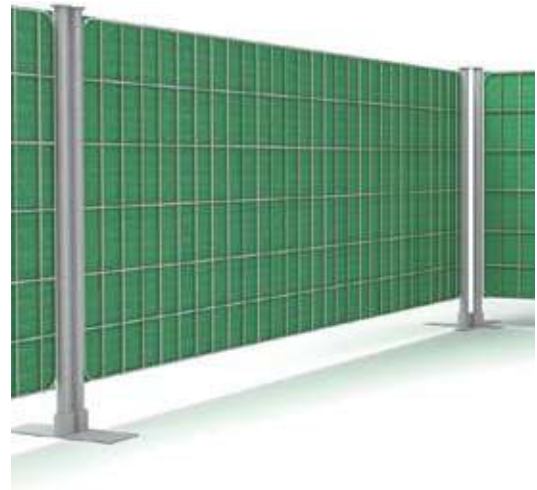

► Ud. Minirrollo ocultación PE/RF 90% FM



		Código	2 x 3,6
Verde claro	PRODUCTO		505292349611
	EAN		8434035063396
Negro	PRODUCTO		505292349666
	EAN		8434035063402
Verde oscuro	PRODUCTO		505292349691
	EAN		8434035063419

► Ud. Malla señalización PE



		Código	0,50 x 50	0,50 x 100	1 x 50	1 x 100
Amarillo /Negro	PRODUCTO		512192009056	512192024056	512192010056	512192008056
	EAN		8434035064461	8434035064492	8434035064485	8434035064454



Antigranizo

Anti hail

Mallas monofilamento de polietileno alta densidad con protección solar UV para proteger las plantaciones de la acción de las tormentas de granizo. Esto permite la tranquilidad de tener la cosecha protegida y asegurar las entregas de producto a los clientes. Su fácil colocación nos da la ventaja de poder llevar a cabo la instalación con apenas medios técnicos especiales.

APLICACIONES: En explotaciones agrarias de plantaciones de frutales y viñedos. En jardinería y viverismo. Y uso doméstico para pequeños huertos y jardines.

Monofilament meshes made from high density polyethylene with anti UV protection, used to protect the harvest from the action produced from hail storm. This gives you peace of mind to know that the harvest is protected and ensure the supply of products to customers. Easily installed, gives you with the advantage of not needing almost any technical means for it.

APLICACIONES: Used in farms, orchards and vineyards, in gardening and garden nurseries. For domestic use; in small gardens and orchards.

Protección anti UV UV protected 

► Ud. Malla PE antigranizo

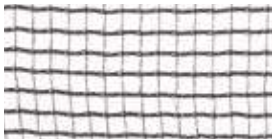

	Código	1 x 100	2 x 100	3 x 100
Negro	PRODUCTO	503107808066	503107810066	503107811066
	EAN	8434035057241	8434035057265	8434035057296

► Ud. Minirollo PE antigranizo

	Código	3 x 10	3 x 20
Negro	PRODUCTO	503107816066	503107817066
	EAN	8434035057302	8434035057319

► M² Malla PE antigranizo

Negro
503107801066

Por su resistencia proporciona una completa protección en plantaciones al aire libre.

For its resistance it provides a complete protection for harvests outdoors.



Mosquiteras

Mosquito net

Página 93 Tarifa. Page 93 Price List.

Malla mosquitera de polietileno con protección solar UV con entramados 6x6, 6x9, 10x16 y 10x20 para proteger de la acción de los insectos y trips. Su uso es imprescindible en invernaderos y en cultivos ecológicos.

APLICACIONES: En invernaderos para permitir la ventilación sin riesgo de ataque por parte de insectos y plagas. En jardinería y viverismo protege de la acción de la lluvia. Y uso doméstico para pequeños huertos y jardines.

Mosquito net made from polyethylene anti UV protected, framework 6x6, 6x9, 10x16 y 10x20 obligatory for greenhouses, orchards and gardens.

APLICACIONES: Used for greenhouses to allow ventilation, without any risk of being attacked by insects or pests, for gardening and nursery gardens to protect against the rain's action; and for domestic use in small gardens and orchards.

Protección anti UV UV protected 

► M² Mosquitera entramado



	Código	Entramado 6x6	6x9	10x16	10x20
Blanco	PRODUCTO	112099000144	126099000344	132099000344	133099000344

Antihierba

Ground cover

Página 93 Tarifa. Page 93 Price List.

Agrotexil de polipropileno color negro para impedir el crecimiento de la hierba y preservar la humedad de la tierra.

APLICACIONES: Diversas aplicaciones en agricultura, viverismo, jardinería, y uso doméstico para pequeños jardines.

Agro textile made from polypropylene, black color to avoid the grass from growing and to preserve the ground humidity.

APLICACIONES: Several applications: in agriculture, green housing, gardening, and domestic use for small gardens.

Protección anti UV UV protected 

► Ud. Malla antihierba



	Código	1,05 x 100	1,30 x 100	2,10 x 100	3,20 x 100	4,20 x 100	5,25 x 100
G100 Negro/v	PRODUCTO	520492903616	520492906616	520492904616	520492905616	520492917616	520492918616
	EAN	8434035065871	8434035065918	8434035065888	8434035065895	8434035066021	8434035066038

► Ud. Minirrollo antihierba

	Código	1,05 x 10	2,10 x 10	1,05 x 20	2,10 x 20
G100 Negro/v	PRODUCTO	520492907616	520492915616	520492910616	520492908616
	EAN	8434035065925	8434035066007	8434035065956	8434035065932





▶ Voladero de aves Flying

Red de cerramiento para la cría de aves.
Closure net for the growth of birds.



▶ Parques aventura Attraction Park

Redes para parques de atracciones al aire libre.
Nets for open space attraction parks.



▶ Entutorado vertical Vertical

Red para plantas trepadoras y entutorar cultivos verticales.
Nets for climbing plants and structure guide plantations.



▶ Entutorado horizontal Horizontal

Red para enderezar y guiar tallos.
Nets to straighten and guide stems.

Producto Product	Descripción Description	Hilo ø Yarn ø	Malla # Malla #	Color Color
5275330201	M2 RED S/NUDO PPM	1,8mm	M20X20	64
5275330401	M2 RED S/NUDO PPM	1,8mm	M30X30	64
5275330801	M2 RED S/NUDO PPM	1,8mm	M50X50	64
5275050401	M2 RED S/NUDO PPM	3mm	M30X30	64
5275050801	M2 RED S/NUDO PPM	3mm	M50X50	64
5275051101	M2 RED S/NUDO PPM	3mm	M100X100	64

Colores disponibles Colors available

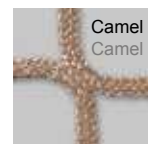
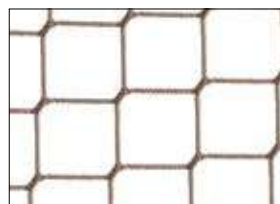

Expositores malla

Shade net exhibitors



Expositor mallas apilables Exhibitor stacking networks

Código Producto Product code	Descripción Description	Medidas Measures
500000000002	Expositor malla sombreado sencillo	1,37 x 0,60 x 0,78



Código Producto Product code	Descripción Description	Medidas Measures
500000000003	Expositor malla sombreado doble	1,75 x 1,20 x 0,80



Código Producto Product code	Descripción Description	Medidas Measures
500000000004	Expositor malla sombreado al corte	2 x 1,60 x 0,40

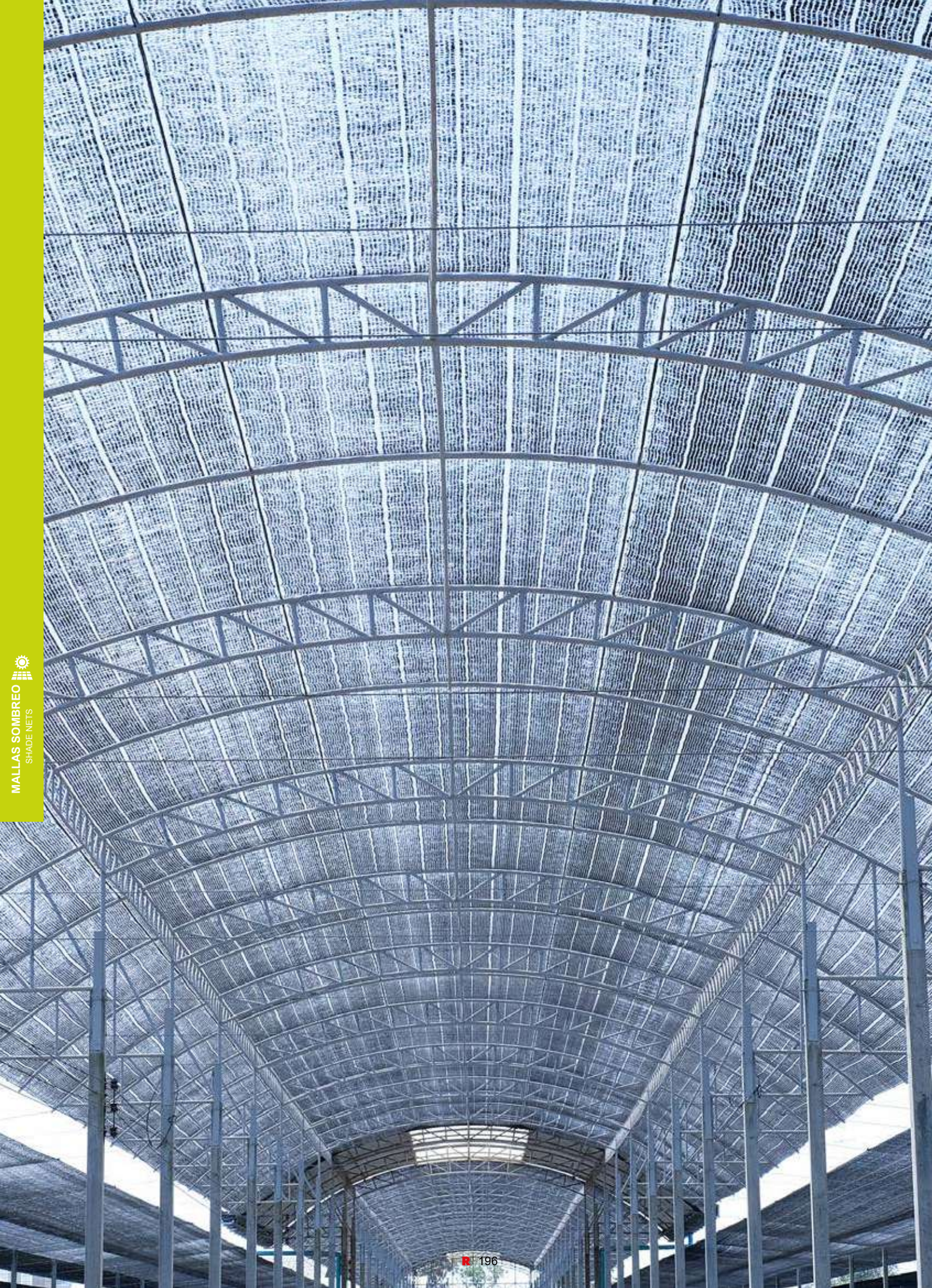

CABUYERÍA NÁUTICA

NAUTICAL ROPES



► Comparativa de características de las fibras Comparative characteristics of the fibers

Cuerda: Producto independiente de su diámetro, fabricado por torsión o trenzado de materias fibrosas, para obtener una cuerda acabada, una línea o un cordón.

Rope: A rope is a length of fibres, twisted or braided together to improve strength for pulling and connecting.

Cordón: Producto retorcido o trenzado, de diámetro habitualmente inferior a 4 mm.

Cord: A small group item of cordage, usually less than 4 mm diameter.

Cableado (cuerda retorcida): Proceso que consiste en fabricar una cuerda de cabos retorciendo o disponiendo cabos conjuntamente para formar una construcción estable que no se desenrede.

Twisting: The number of turns about the axis applied to a fiber, yarn, strand or rope over a given length to combine the individual elements into a larger and stronger structure.

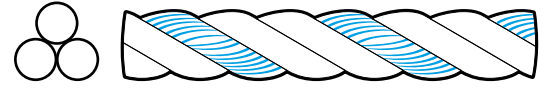

Trenzado: Proceso que consiste en entrelazar los materiales de la cuerda de manera helicoidal, de modo que el número de filamentos o de hilos que forman hélices en una dirección se equilibra por un número igual de filamentos o de hilos que forman hélices en la dirección opuesta.

Braiding: It is the process of interlacing three or more strands of a "flexible fiber to create long and narrow structures.

Cuerda de trenzado doble: Cuerda en la que un determinado número de cabos están trenzados para formar un alma, alrededor de la cual se trenzan otros cabos para formar una funda.

Double braided rope: Two ropes in one, a braided core is over-braided with a cover braid, hence the terms braid on braid and 2 in 1 braid. It is an exceptionally strong rope construction of a core braid container within an outer braided jacket.

RFS - Rombull Fix System: Sistema de terminado de cabos, especialmente desarrollado para las líneas de cordelería y cabullería. Su función principal es producir una estabilidad en las fibras que conforman el cabo, prolongando su vida útil. Este proceso dota a la cuerda de una amabilidad y consistencia que la hacen ideal para su uso como cabos náuticos.

RFS - Rombull Fix System: Strand finishing system, specially developed for cordage lines. Its main function is to provide stability to all the fibres which form the strand, making larger its time of use. This process makes the rope softer and consistent, characteristics that are ideal for its use as nautical strand.

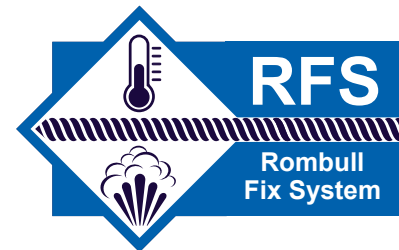
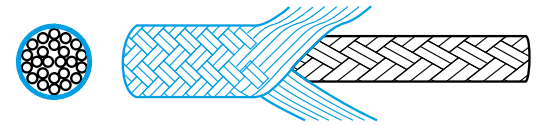

Driza: Cuerda o cabo utilizado para izar o arriar las velas.

Halyard: Rope for raising and lovening a ship's sail.

Escota: Cabo que sirve para tensar las velas.

Sheet: Rope used for tensing a ship's sail.

Maroma: Cuerda utilizada para remolcar o amarrar un barco.

Mooring rope: Rope used to moor and dock a boat.

► Comparativa de características de las fibras Comparative characteristics of the fibers

NOTA: se utiliza nylon como base de 1.0 **NOTE:** nylon is used as the basis of 1.0

Tipo de Fibra Genérica Generic Fiber Type	Nylon	Poliéster Polyester	Polipropileno Polypropylene
Tenacidad (g/den) 1 Tenacity (g/den) 1	7.5 - 10.5	7 - 10	6.5
Elongación 2 Elongation 2	15 - 28%	12 - 18%	18 - 22%
Coefficiente de Fricción 3 Coefficient of Friction 3	.12 - .15	.12 - .15	.15 - .22
Punto de Fusión Melting point	425° - 490° F	480° - 500° F	330° F
Temperatura Crítica 4 Critical Temperature 4	325° F	350° F	250° F
Gravedad Específica Specific Gravity	1.14	1.38	.91

1 **Tenacidad:** es la medida de resistencia a la rotura de las fibras.

2 **Elongación:** se refiere al porcentaje de elongación de las fibras hasta la rotura.

3 **Coefficiente de Fricción:** basado en la tendencia a la rozadura.

4 **Temperatura Crítica:** se refiere al punto en el que la degradación está causada únicamente por la temperatura.

1 **Tenacity** is the measurement of the resistance of the fibers to breaking.

2 **Elongation** refers to the percentage of elongation of the fibers at break.

3 **Coefficient of friction:** is based on reluctance to slip or slide.

4 **Critical temperature:** it refers to the point at which degradation is caused by temperature it self.



Novoleen
Novoleen



- 1 **Driza mayor / Large halyard**
 - Cabo Rombull Vega Novoleen
 - Cabo Rombull Nashira
- 2 **Sables / Dirk**
 - Cabo Rombull Vega Novoleen
 - Cabo Rombull Nashira
- 3 **Pujamen / Spi-Sheet rigging**
 - Cabo Rombull Vega Novoleen
- 4 **Spinnaker guy**
 - Cabo Rombull Vega Novoleen
 - Cabo Rombull Nashira
- 5 **Backstays**
 - Cabo Rombull Vega Novoleen
 - Cabo Amarre Rombull Tureis
- 6 **Punto de amarre / Mooring**
 - Cabo Amarre Rombull Tureis
 - Cabo Rombull Minkar

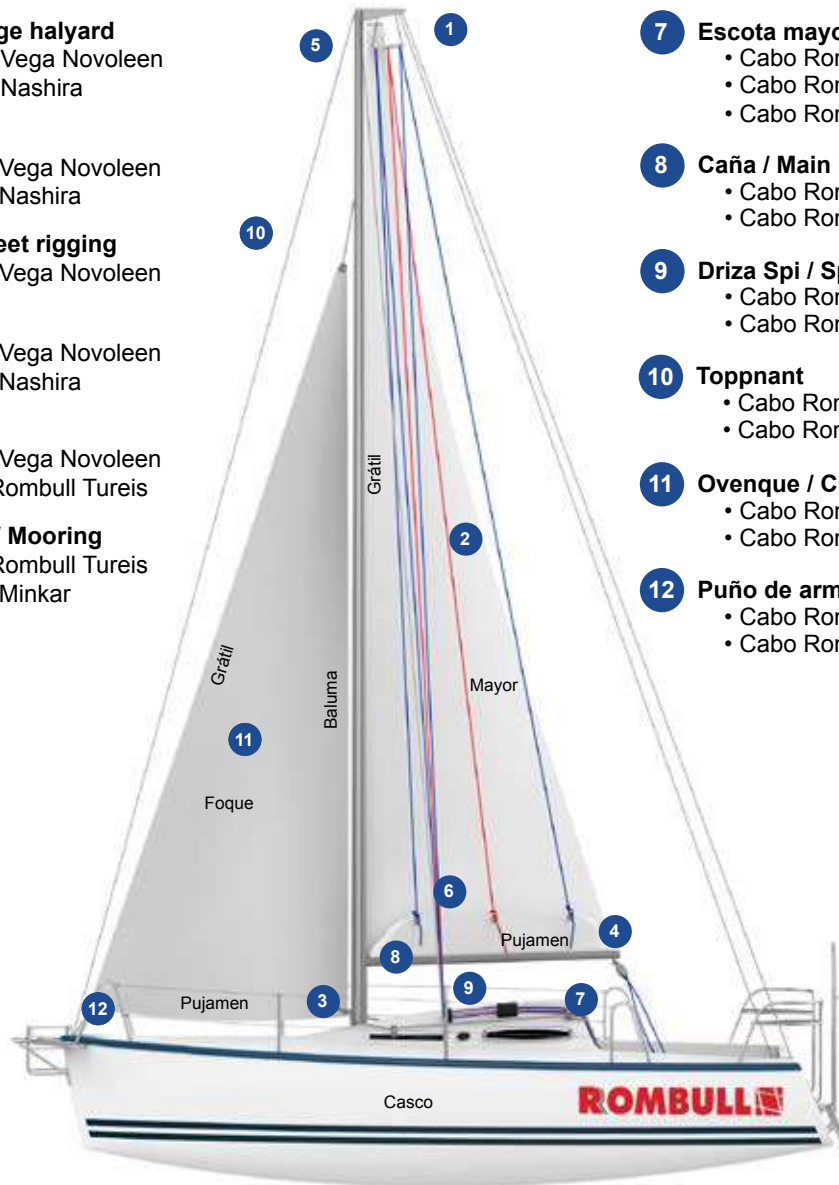

- 7 **Escota mayor / Large sheet rigging**
 - Cabo Rombull Vega Novoleen
 - Cabo Rombull Nashira
 - Cabo Rombull Situla Novoleen
- 8 **Caña / Main Boom**
 - Cabo Rombull Vega Novoleen
 - Cabo Rombull Nashira
- 9 **Driza Spi / Spi halyard**
 - Cabo Rombull Vega Novoleen
 - Cabo Rombull Nashira
- 10 **Toppnant**
 - Cabo Rombull Vega Novoleen
 - Cabo Rombull Nashira
- 11 **Ovenque / Cunningham**
 - Cabo Rombull Vega Novoleen
 - Cabo Rombull Nashira
- 12 **Puño de armura / Furling lines**
 - Cabo Rombull Vega Novoleen
 - Cabo Rombull Nashira

El **UHMWPE** es inodoro, insípido y no tóxico. Posee las características del polietileno de alta densidad con el añadido de ser resistente a los ácidos y álcalis concentrados, así como a numerosos disolventes orgánicos. Es altamente resistente a los químicos corrosivos excepto a los ácidos oxidantes; tiene una absorción de humedad extremadamente baja y un coeficiente de fricción muy bajo; y es altamente resistente a la abrasión, en algunas formas es 15 veces más resistente a la abrasión que el acero al carbono.

UHMWPE is odorless, tasteless, and nontoxic. It embodies all the characteristics of high-density polyethylene (HDPE) with the added traits of being resistant to concentrated acids and alkalis, as well as numerous organic solvents. It is highly resistant to corrosive chemicals, except oxidising acids; has extremely low moisture absorption and a very low coefficient of friction; is self-lubricating; and is highly resistant to abrasion, in some forms being 15 times more resistant to abrasion than carbon steel.

Tipo de Fibra Genérica Generic Fiber Type	UHMW UHMW
Tenacidad (g/den) 1 Tenacity (g/den) 1	4,5
Elongación 2 Elongation 2	6%
Punto de Fusión Melting point	290° F
Temperatura Crítica 3 Critical Temperature 3	180° F
Gravedad Específica Specific Gravity	0,97

- 1 **Tenacidad:** es la medida de resistencia a la rotura de las fibras.
 - 2 **Elongación:** se refiere al porcentaje de elongación de las fibras hasta la rotura.
 - 3 **Temperatura Crítica:** se refiere al punto en el que la degradación está causada únicamente por la temperatura.
- 1 **Tenacity** is the measurement of the resistance of the fibers to breaking.
 - 2 **Elongation** refers to the percentage of elongation of the fibers at break.
 - 3 **Critical temperature:** it refers to the point at which degradation is caused by temperature it self.



Cabo Rombull Minkar

Rombull Minkar strand

Driza trenzada 12 cabos, fabricada en multifilamentos de polipropileno 100% alta tenacidad. Gran resistencia a la tracción. No pierde flexibilidad en el uso.

12 strand twisted halyard strand manufactured in 100% high tenacity PP multifilaments. Great resistance to traction, soft and does not loose flexiblity.

Grosor Thickness	Metros Meters	Resistencia Resistance	Código Code	Negro
12 mm	300 m	2600 kg	PRODUCTO	618016003366
			EAN	8434035107298
14 mm	200 m	3200 kg	PRODUCTO	618017001066
			EAN	8434035107304
16 mm	180 m	4000 kg	PRODUCTO	618018002566
			EAN	8434035107311
18 mm	130 m	4500 kg	PRODUCTO	618019002466
			EAN	8434035107328
20 mm	100 m	4800 kg	PRODUCTO	618020000966
			EAN	8434035107335
22 mm	80 m	5700 kg	PRODUCTO	618022002666
			EAN	8434035107342
25 mm	80 m	6300 kg	PRODUCTO	618046002666
			EAN	8434035107366
30 mm	50 m	7400 kg	PRODUCTO	618029001166
			EAN	8434035107359



Cabo Rombull Adhara (cuerda amarre)

Rombull Adhara strand (moorage rope)



Página 98 Tarifa. Page 98 Price List.

Cabo de poliéster alta tenacidad en 3 cabos. De tacto amable y flexible. Fabricado con Sistema Rombull Fix. Gran resistencia a la tracción. Utilizado como cuerda de amarre. De fácil anudabilidad.

High tenacity twisted rope with 3 strands. Comfortable and flexible touch. Manufactured with Rombull Fix System. Great traction resistance. Used as rope for moorage. Very easy knotting.

Grosor Thickness	Metros Meters	Resistencia Resistance	Código Code	Blanco	Azul marino	Negro
6 mm	100 m	580 kg	PRODUCTO	605010000944	605010000921	605010000966
			EAN	8434035074705	8434035074729	8434035074743
6 mm	200 m	580 kg	PRODUCTO	605010001044	605010001021	605010001066
			EAN	8434035074712	8434035074736	8434035074750
8 mm	100 m	950 kg	PRODUCTO	605012000944	605012000921	605012000966
			EAN	8434035074767	8434035074781	8434035074804
8 mm	200 m	950 kg	PRODUCTO	605012001044	605012001021	605012001066
			EAN	8434035074774	8434035074798	8434035074811
10 mm	100 m	1450 kg	PRODUCTO	605014000944	605014000921	605014000966
			EAN	8434035074828	8434035074835	8434035074842
12 mm	100 m	2100 kg	PRODUCTO	605016000944	605016000921	605016000966
			EAN	8434035074859	8434035074866	8434035074873
14 mm	100 m	2800 kg	PRODUCTO	605017000944	605017000921	605017000966
			EAN	8434035074880	8434035074897	8434035074903
16 mm	100 m	4150 kg	PRODUCTO	605018000944	605018000921	605018000966
			EAN	8434035074910	8434035074927	8434035074934
18 mm	100 m	4750 kg	PRODUCTO	605019000944	605019000921	605019000966
			EAN	8434035074941	8434035074958	8434035074965
20 mm	100 m	5500 kg	PRODUCTO	605020000944	605020000921	605020000966
			EAN	8434035074972	8434035074989	8434035074996



Accesorios de amarre

Moorage accessories

► Ud. Cabo spiral Rombull Alkes (gaza + guardacabo + mosquetón)

Cabo trenzado Birotex DIN 8337. Fabricado en polipropileno multifilamento de alta densidad. Terminación en gaza con guardacabo galvanizado 10x70, mosquetón 11x120 inoxidable y resistente a la descomposición. Válido para amarre. No absorbe agua.

Spiral braided rope Birotex rope DIN 83307, Form H, PP multifilament fixed high, non-rotating, ready spliced with thimble, galvanized ring 10x70, hinged carabineer hook 10x120, rot and decay resistant.



Grosor Thickness	Metros Meters	Resistencia Resistance	Código Code	Blanco
16 mm	20 m	1900 kg	PRODUCTO	619018001844
			EAN	8434035129559
16 mm	30 m	1900 kg	PRODUCTO	619018001944
			EAN	8434035129566

► Ud. Cabo plomado Rombull Alnair (gaza + guardacabo)

Cabo doble de poliéster trenzado, con núcleo de plomo trenzado alrededor de los primeros 10 metros hacia el anclaje. Puede reemplazar cadenas y cadenas pre-empalmadas en la mayoría de los casos. Con guardacabo de acero inoxidable precortado y sin corrosión. No causa daño a la cubierta y al barniz. También es ideal para usar como cuerda de ancla de popa.

Double braided polyester rope with lead core braided around first 10 meters towards the anchor. Can replace chains and chain fore-run in most cases. With non-corrosive, pre-spliced stainless steel thimble. Does not cause damage to varnish and outer skin. Also ideal for use as stern anchor rope.



Grosor Thickness	Metros Meters	Resistencia Resistance	Código Code	Blanco
10 mm	30 m	1630 kg	PRODUCTO	623014001944
			EAN	8434035107687
12 mm	40 m	2290 kg	PRODUCTO	623016005144
			EAN	8434035107700
14 mm	40 m	3030 kg	PRODUCTO	623017005144
			EAN	8434035107717
16 mm	40 m	3900 kg	PRODUCTO	623018005144
			EAN	8434035119567



► Ud. Cabo amarre Rombull Tureis (gaza + guardacabo)

Página 99 Tarifa. Page 99 Price List.

Cabos de amarre listos para usar. Resistentes a la abrasión, sin torceduras. No endurecen en contacto con el agua.

A- Terminación en gaza con guardacabo de acero inoxidable pre-empalmado.

B- Terminación en gaza 40 cm.

Ready-to-use anchor rope. Non-hardening, abrasion resistant and kink free.

A.- One side pre-spliced with a stainless steel thimble for the anchor.

B.- One side spliced in a 40 cm loop.



Grosor Thickness	Metros Meters	Resistencia Resistance	Código Code	Blanco/Negro
10 mm	30 m	1900 kg	PRODUCTO	622014001946
			EAN	8434035113985
12 mm	30 m	2500 kg	PRODUCTO	622016001946
			EAN	8434035113992
14 mm	30 m	3700 kg	PRODUCTO	622017001946
			EAN	8434035114005
16 mm	30 m	4300 kg	PRODUCTO	622018001946
			EAN	8434035114012

► Ud. Cabo amarre Rombull Tureis gaza



Grosor Thickness	Metros Meters	Resistencia Resistance	Código Code	Blanco/ Negro	Azul marino	Gris
12 mm	8 m	2500 kg	PRODUCTO	621016003446	621016003422	621016003461
			EAN	8434035107465	8434035107458	8434035107472
12 mm	12 m	2500 kg	PRODUCTO	621016007446	621016007422	621016007461
			EAN	8434035107496	8434035107489	8434035107502
14 mm	8 m	3700 kg	PRODUCTO	621017003446	621017003422	621017003461
			EAN	8434035107526	8434035107519	8434035107533
14 mm	14 m	3700 kg	PRODUCTO	621017009746	621017009722	621017009761
			EAN	8434035108103	8434035108097	8434035108110
16 mm	8 m	4400 kg	PRODUCTO	621018003446	621018003422	621018003461
			EAN	8434035107588	8434035107571	8434035107595
16 mm	15 m	4400 kg	PRODUCTO	621018001746	621018001722	621018001761
			EAN	8434035108066	8434035108059	8434035108073

Resistente a los Rayos UV
UV-resistant

► Ud. Cabo amarre Rombull Tureis (gaza + guardacabo + ancla)



Cabo de amarre listo para usar. Resistente a la abrasión, sin torceduras. Conjunto completo que consta de 30 metros de cuerda de anclaje preempalmado con terminación en ancla de acero inoxidable, anillo de 12 mm y ancla plegable de 6 kg.

30 meters anchor rope, 10mm, pre-spliced and rigged stainless steel thimble, 12mm shackle and 6 kg folding anchor.

Grosor Thickness	Metros Meters	Resistencia Resistance	Código Code	Blanco/Negro
10 mm	30 m	1900 kg	PRODUCTO	624014001946
			EAN	8434035107724

Cabo Rombull Serpens

Rombull Serpens strand

Página 100 Tarifa. Page 100 Price List.

Cabo trenzado para usos diversos. Fabricado en monofilamentos de polietileno de alta densidad. Protección solar. Flotabilidad. Válido para deportes acuáticos, esquí náutico y líneas de flotación. No absorbe agua.

Twisted strand for different uses. Manufactured with high density polyethylene monofilaments. Sun protection. Floatability. Used in water sports, nautical ski and floating lines. Does not absorb water.

Grosor Thickness	Metros Meters	Resistencia Resistance	Código Code	Blanco	Amarillo p. roja
				PRODUCTO	PRODUCTO
6 mm	200 m	150 kg	PRODUCTO	602010001044	602010001055
				EAN	8434035075016
6 mm	100 m	150 kg	PRODUCTO	602010000944	602010000955
				EAN	8434035075009
8 mm	200 m	400 kg	PRODUCTO	602012001044	602012001055
				EAN	8434035075030
8 mm	100 m	400 kg	PRODUCTO	602012000944	602012000955
				EAN	8434035075023
10 mm	100 m	680 kg	PRODUCTO	602014000944	602014000955
				EAN	8434035075047
12 mm	100 m	850 kg	PRODUCTO	602016000944	602016000955
				EAN	8434035075054

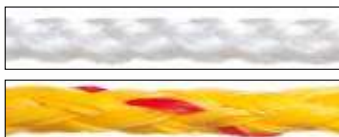

Cabo Rombull Antares

Rombull Antares strand

Página 100 Tarifa. Page 100 Price List.

Cabo de gran resistencia a la abrasión, gracias a su sistema de trenzado, duradero y de múltiples aplicaciones, recomendado para embarcaciones de paseo. Fabricado en poliéster de alta tenacidad con doble trenzado. Protección solar, ideal para uso en escota.

Strand with great resistance to abrasion, thanks to its twisting system. Durable and with many different applications. Manufactured in double twisted high tenacity polyester. Sun Protectit it is ideal for use in sheet.

Grosor Thickness	Metros Meters	Resistencia Resistance	Código Code	Blanco p. negra
6 mm	200 m	850 kg	PRODUCTO	609010661044
			EAN	8434035075719
6 mm	100 m	850 kg	PRODUCTO	609010660944
			EAN	8434035075702
8 mm	200 m	1500 kg	PRODUCTO	609012661044
			EAN	8434035075733
8 mm	100 m	1500 kg	PRODUCTO	609012660944
			EAN	8434035075726
10 mm	100 m	2250 kg	PRODUCTO	609014660944
			EAN	8434035075740
12 mm	100 m	3000 kg	PRODUCTO	609016660944
			EAN	8434035075757
14 mm	100 m	3500 kg	PRODUCTO	609017660944
			EAN	8434035075764
16 mm	100 m	3900 kg	PRODUCTO	609018660944
			EAN	8434035075771
18 mm	100 m	4500 kg	PRODUCTO	609019660944
			EAN	8434035075788
20 mm	100 m	5100 kg	PRODUCTO	609020660944
			EAN	8434035075795



Cabo Rombull Altair

Rombull Altair strand



Cabo de alta calidad fabricado en multifilamentos de poliéster de alta tenacidad, fabricado para su uso en embarcaciones. Muy buena resistencia a la abrasión y fácil de enganazar. Producto termofijado. Uso en escotas y drizas.

High quality strand manufactured in high tenacity polyester multifilaments. Very good resistance to abrasion and easily to set up. Thermo fixed item. Used in halyards or sheets.

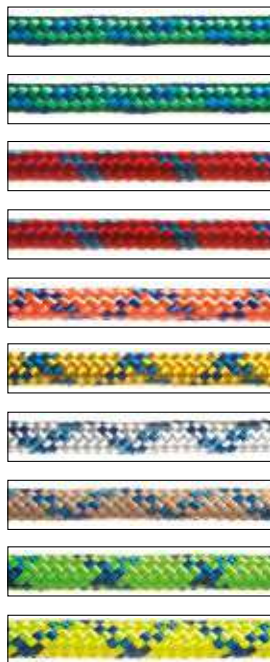

Grosor Thickness	Metros Meters	Resistencia Resistance	Código Code	
6 mm	200 m	800 kg	PRODUCTO	606010221011
			EAN	8434035075818
6 mm	100 m	800 kg	PRODUCTO	606010220911
			EAN	8434035075801
8 mm	200 m	1350 kg	PRODUCTO	606012221033
			EAN	8434035075832
8 mm	100 m	1350 kg	PRODUCTO	606012220933
			EAN	8434035075825
10 mm	100 m	2400 kg	PRODUCTO	606014220977
			EAN	8434035075849
12 mm	100 m	2900 kg	PRODUCTO	606016220955
			EAN	8434035075856
14 mm	100 m	3500 kg	PRODUCTO	606017220944
			EAN	8434035075863
16 mm	100 m	4100 kg	PRODUCTO	606018220964
			EAN	8434035075870
18 mm	100 m	4600 kg	PRODUCTO	606019220910
			EAN	8434035075887
20 mm	100 m	5500 kg	PRODUCTO	606020220950
			EAN	8434035075894



Cabo Rombull Spica

Rombull Spica strand



Página 101 Tarifa. Page 101 Price List.

Cabo de alta calidad y diferentes usos, fabricado para su uso en embarcaciones varias, de fácil identificación en maniobra por la diversidad de colores. Muy buena resistencia a la abrasión y fácil de engarzar. Producto termofijado. Uso en escotas y drizas.

High quality strand with many different nautical uses. With a wide range of colours for its easy identification. Very resistant to abrasion and easily to set up. Thermo fixed item used in halyards and sheets.

Grosor Thickness	Metros Meters	Resistencia Resistance	Código Code	Verde flúor	Azul	Rojo	Naranja flúor	Amarillo flúor
6 mm	100 m	800 kg	PRODUCTO	606010000910	606010000922	606010000933	606010000970	606010000950
			EAN	8434035075207	8434035075221	8434035075245	8434035075269	8434035075283
6 mm	200 m	800 kg	PRODUCTO	606010001010	606010001022	606010001033	606010001070	606010001050
			EAN	8434035075214	8434035075238	8434035075252	8434035075276	8434035075290
8 mm	100 m	1350 kg	PRODUCTO	606012000910	606012000922	606012000933	606012660970	606012000950
			EAN	8434035075306	8434035075320	8434035075344	8434035075368	8434035075382
8 mm	200 m	1350 kg	PRODUCTO	606012001010	606012001022	606012001033	606012001070	606012001050
			EAN	8434035075313	8434035075337	8434035075351	8434035075375	8434035075399
10 mm	100 m	2400 kg	PRODUCTO	606014000910	606014000922	606014000933	606014000970	606014000950
			EAN	8434035075405	8434035075412	8434035075429	8434035075436	8434035075443
12 mm	100 m	2900 kg	PRODUCTO	606016000910	606016000922	606016000933	606016000970	606016000950
			EAN	8434035075450	8434035075467	8434035075474	8434035075481	8434035075498
14 mm	100 m	3500 kg	PRODUCTO	606017000910	606017000922	606017000933	606017000970	606017000950
			EAN	8434035075504	8434035075511	8434035075528	8434035075535	8434035075542
16 mm	100 m	4100 kg	PRODUCTO	606018000910	606018000922	606018000933	606018000970	606018000950
			EAN	8434035075559	8434035075566	8434035075573	8434035075580	8434035075597
18 mm	100 m	4600 kg	PRODUCTO	606019000910	606019000922	606019000933	606019000970	606019000950
			EAN	8434035075603	8434035075610	8434035075627	8434035075634	8434035075641
20 mm	100 m	5100 kg	PRODUCTO	606020000910	606020000922	606020000933	606020000970	606020000950
			EAN	8434035075658	8434035075665	8434035075672	8434035075689	8434035075696



Cabo Rombull Sirio

Rombull Sirio strand



Driza trenzada, fabricada en multifilamentos de poliéster 100% alta tenacidad. Gran resistencia a la tracción. Suave y flexible.
Twisted strand manufactured in 100% high tenacity polyester multifilaments. Great resistance to traction, soft and flexible.



Grosor Thickness	Metros Meters	Resistencia Resistance	Código Code	
6 mm	200 m	800 kg	PRODUCTO	609010991044
			EAN	8434035075917
6 mm	100 m	800 kg	PRODUCTO	609010990944
			EAN	8434035075900
8 mm	200 m	1350 kg	PRODUCTO	609012991044
			EAN	8434035075931
8 mm	100 m	1350 kg	PRODUCTO	609012990944
			EAN	8434035075924
10 mm	100 m	2400 kg	PRODUCTO	609014990944
			EAN	8434035075948
12 mm	100 m	2900 kg	PRODUCTO	609016990944
			EAN	8434035075955
14 mm	100 m	3500 kg	PRODUCTO	609017990944
			EAN	8434035075962
16 mm	100 m	4100 kg	PRODUCTO	609018990944
			EAN	8434035075979
18 mm	100 m	4600 kg	PRODUCTO	609019990944
			EAN	8434035075986
20 mm	100 m	5500 kg	PRODUCTO	609020990944
			EAN	8434035075993





Cabo Rombull Nashira

Rombull Nashira strand

Driza fabricada en multifilamentos de poliéster de calidad suprema. Alta resistencia. Óptima resistencia a la abrasión. Baja elasticidad. Baja elongación. Especial uso náutico.

Sheath-core fabric double braided top quality Special. Extremely high strength. Optimal abrasion resistance on the winch. Low elasticity. Low flexibility.

Grosor Thickness	Metros Meters	Resistencia Resistance	Código Code	 Blanco/Negro	 Blanco/Rojo	 Blanco/Verde
8 mm	150 m	2400 kg	PRODUCTO	610012664144	610012334144	610012114144
			EAN	8434035106840	8434035106840	8434035106826
10 mm	250 m	3400 kg	PRODUCTO	610014662944	610014332944	610014112944
			EAN	8434035106871	8434035106864	8434035106857
12 mm	150 m	4500 kg	PRODUCTO	610016664144	610016334144	610016114144
			EAN	8434035106901	8434035106895	8434035106888
14 mm	250 m	5300 kg	PRODUCTO	610017662944	610017332944	610017112944
			EAN	8434035106932	8434035106925	8434035106918





Cabo Rombull Tureis Novoleen

Rombull Tureis Novoleen strand



Página 103 Tarifa. Page 103 Price List.

Cabo fabricado en fibra de alta tecnología Novoleen. Resistencia comparable a un cable de acero, pero 14 veces más ligera. Alta resistencia a la abrasión. Revestimiento protector SF PU12. Facilidad de nudo. Baja absorción a la suciedad. Muy ligera. Resistencia excelente. Especial para uso náutico.

Rope made of Novoleen - The High Tech fiber- resilient like a wire rope but up to 14 times lighter. Only use fittings that can also take up high breaking loads, heat set, protective coating SF-PU 12, floatable, optimal for eight recuperate, traps and spinnaker sheets for standard-compliant (DIN/EN). Wind ropes and easy to splice.

Grosor Thickness	Metros Meters	Resistencia Resistance	Código Code	Gris
3 mm	200 m	750 kg	PRODUCTO	611005000361
			EAN	8434035106949
5 mm	100 m	3150 kg	PRODUCTO	611009000361
			EAN	8434035106963
8 mm	200 m	5900 kg	PRODUCTO	611012000361
			EAN	8434035106987
10 mm	100 m	9900 kg	PRODUCTO	611014000361
			EAN	8434035106994





Cabo Rombull Vega Novoleen

Rombull Vega Novoleen strand



Página 103 Tarifa. Page 103 Price List.

Driza trenzada con fibra Novoleen que hacen de esta una cuerda muy flexible. Alta resistencia. Baja elasticidad. Alta carga de rotura. Alta resistencia a la abrasión.

Rope with core made of braided, high-strength Novoleen fiber, making the rope flexible. Low elasticity, high break load and high abrasion resistance.

Grosor Thickness	Metros Meters	Resistencia Resistance	Código Code	Azul/Rojo	Rojo
8 mm	200 m	3200 kg	PRODUCTO	613012331022	613012111033
			EAN	8434035107106	8434035107090
10 mm	200 m	5000 kg	PRODUCTO	613014331022	613014111033
			EAN	8434035107120	8434035107113
12 mm	200 m	6100 kg	PRODUCTO	613016331022	613016111033
			EAN	8434035107144	8434035107137





Cabo Rombull Situla Novoleen

Rombull Situla Novoleen strand



Página 103 Tarifa. Page 103 Price List.

Cabo trenzado 8 cabos mezclada con Novoleen SK78 y fibra cortada de poliéster. Mezcla tacto suave y áspero. Alto rendimiento con agarre extra. Alta flexibilidad y agarre.

8-plait, blended from Novoleen SK78 and polyester staple fiber. Especially supple and grippy braid for excellent handling attributes, outstanding for use with jammers, high knotted strength and excellent dinghy sheet.

Grosor Thickness	Metros Meters	Resistencia Resistance	Código Code	Blanco/Verde	Blanco/Rojo
6 mm	200 m	1200 kg	PRODUCTO	614010001014	614010001034
			EAN	8434035113183	8434035113190
8 mm	200 m	1800 kg	PRODUCTO	614012001014	614012001034
			EAN	8434035113206	8434035113213
10 mm	200 m	2900 kg	PRODUCTO	614014001014	614014001034
			EAN	8434035113220	8434035113244



Cabo Rombull Deneb

Rombull Deneb strand

Página 104 Tarifa.
Page 104 Price List.

Escota fabricada con alma de poliéster alta tenacidad trenzada y exterior de poliéster peinado trenzado de alta calidad. Tacto muy suave. Resistente. Muy buenas prestaciones en winches y mordazas. Fácil manejo. Buena anudabilidad. Diversos colores para una fácil identificación de maniobra.

Strand made out of a twisted high tenacity polyester soul and a high quality coiffured twisted polyester. Very soft touch. Resistant. Very good clamp and winches characteristics. Good knotting. Easy to use. Wide range of colours to choose for an easy identification.

Grosor Thickness	Metros Meters	Resistencia Resistance	Código Code	
6 mm	200 m	650 kg	PRODUCTO	608010331044
			EAN	8434035076013
6 mm	200 m	650 kg	PRODUCTO	608010441033
			EAN	8434035076082
6 mm	100 m	650 kg	PRODUCTO	608010330944
			EAN	8434035076006
6 mm	100 m	650 kg	PRODUCTO	608010440933
			EAN	8434035076075
8 mm	200 m	1250 kg	PRODUCTO	608012551044
			EAN	8434035076037
8 mm	200 m	1250 kg	PRODUCTO	608012221055
			EAN	8434035076105
8 mm	100 m	1250 kg	PRODUCTO	608012550944
			EAN	8434035076020
8 mm	100 m	1250 kg	PRODUCTO	608012220955
			EAN	8434035076099
10 mm	100 m	1500 kg	PRODUCTO	608014220944
			EAN	8434035076044
10 mm	100 m	1500 kg	PRODUCTO	608014440922
			EAN	8434035076112
12 mm	100 m	1950 kg	PRODUCTO	608016220944
			EAN	8434035076051
12 mm	100 m	1950 kg	PRODUCTO	608016440922
			EAN	8434035076129
14 mm	100 m	2000 kg	PRODUCTO	608017110944
			EAN	8434035076068
14 mm	100 m	2000 kg	PRODUCTO	608017440911
			EAN	8434035076136





Cabo Rombull Cursa

Rombull Cursa strand

Página 104 Tarifa. Page 104 Price List.

Driza trenzada 16 cabos con núcleo en PP. Alta resistencia al agarre y abrasión. Resistente a rayos UV. Alta flexibilidad. Especial uso náutico.

The 16-plait UV resistant sheath combines grip and abrasion resistance. The high-strength PP core optimizes its suppleness and weight.

Grosor Thickness	Metros Meters	Resistencia Resistance	Código Code	Gris
9 mm	150 m	1050 kg	PRODUCTO	615013004196
			EAN	8434035107212
11 mm	80 m	1700 kg	PRODUCTO	615015002696
			EAN	8434035107229





Cabo Rombull Gatria

Rombull Gatria strand

Página 105 Tarifa. Page 105 Price List.

Escota. Alta carga de trabajo. Baja elasticidad. Buen agarre. Alta resistencia. Buena anudabilidad. Diseño atractivo.
High strength rope. Low elasticity. Good splice ability. Increased grip. Attractive design.

Grosor Thickness	Metros Meters	Resistencia Resistance	Código Code	Amarillo Neón
6 mm	300 m	1050 kg	PRODUCTO	616010000350
			EAN	8434035113626
8 mm	200 m	2200 kg	PRODUCTO	616012000350
			EAN	8434035113596
10 mm	180 m	2900 kg	PRODUCTO	616014000350
			EAN	8434035113602



LÍNEA CLÁSICA

CLASSIC LINE



Página 105 Tarifa. Page 105 Price List.

En esta línea clásica encontramos todas las propiedades de una cuerda sintética, con el aspecto de una cuerda de fibra natural. Línea diseñada principalmente para embarcaciones y veleros clásicos, utilizada también como decoración.

Line developed to be used in classic nautical vehicles but also as decoration. We can find all properties of a synthetic rope with the look of a natural fibre rope.

Cabo Rombull Natura-C

Rombull Natura-C strand

Cabo de amarre, cableado de poliéster alta tenacidad en 3 cabos. Adecuado para todo tipo de embarcaciones incluyendo las de tipo tradicional. Fácil de engarzar. Con Sistema Rombull Fix. Suave y manejable. Antideslizante.

Rope used for moorage. Manufactured in high tenacity 3 twisted polyester strands. Used in nautical vehicles, including traditional types. With Rombull Fix System.



Grosor Thickness	Metros Meters	Resistencia Resistance	Código Code	
6 mm	200 m	580 kg	PRODUCTO	605010001064
			EAN	8434035076259
6 mm	100 m	580 kg	PRODUCTO	605010000964
			EAN	8434035076242
8 mm	200 m	950 kg	PRODUCTO	605012001064
			EAN	8434035076273
8 mm	100 m	950 kg	PRODUCTO	605012000964
			EAN	8434035076266
10 mm	100 m	1450 kg	PRODUCTO	605014000964
			EAN	8434035076280
12 mm	100 m	2100 kg	PRODUCTO	605016000964
			EAN	8434035076297
14 mm	100 m	2800 kg	PRODUCTO	605017000964
			EAN	8434035076303
16 mm	100 m	4150 kg	PRODUCTO	605018000964
			EAN	8434035076310
18 mm	100 m	4750 kg	PRODUCTO	605010090964
			EAN	8434035076327
20 mm	100 m	5500 kg	PRODUCTO	605020000964
			EAN	8434035076334



Cabo Rombull Natura-T

Rombull Natura-T strand



Página 106 Tarifa. Page 106 Price List.

Escota trenzada con alma de poliéster alta tenacidad. Amable al tacto. Cabo duradero. Protección solar. Sistema Rombull Fix.
Twisted strand with high tenacity polyester. Soft touch. Durable. Sun protected. Easy to engaged. With Rombull Fix System.

Grosor Thickness	Metros Meters	Resistencia Resistance	Código Code	
6 mm	200 m	850 kg	PRODUCTO	606010001064
			EAN	8434035076150
6 mm	100 m	850 kg	PRODUCTO	606010000964
			EAN	8434035076143
8 mm	200 m	1500 kg	PRODUCTO	606012001064
			EAN	8434035076174
8 mm	100 m	1500 kg	PRODUCTO	606012000964
			EAN	8434035076167
10 mm	100 m	2250 kg	PRODUCTO	606014000964
			EAN	8434035076181
12 mm	100 m	3000 kg	PRODUCTO	606016000964
			EAN	8434035076198
14 mm	100 m	3500 kg	PRODUCTO	606017000964
			EAN	8434035076204
16 mm	100 m	3900 kg	PRODUCTO	606018000964
			EAN	8434035076211
18 mm	100 m	4500 kg	PRODUCTO	606010090964
			EAN	8434035076228
20 mm	100 m	5100 kg	PRODUCTO	606020000964
			EAN	8434035076235

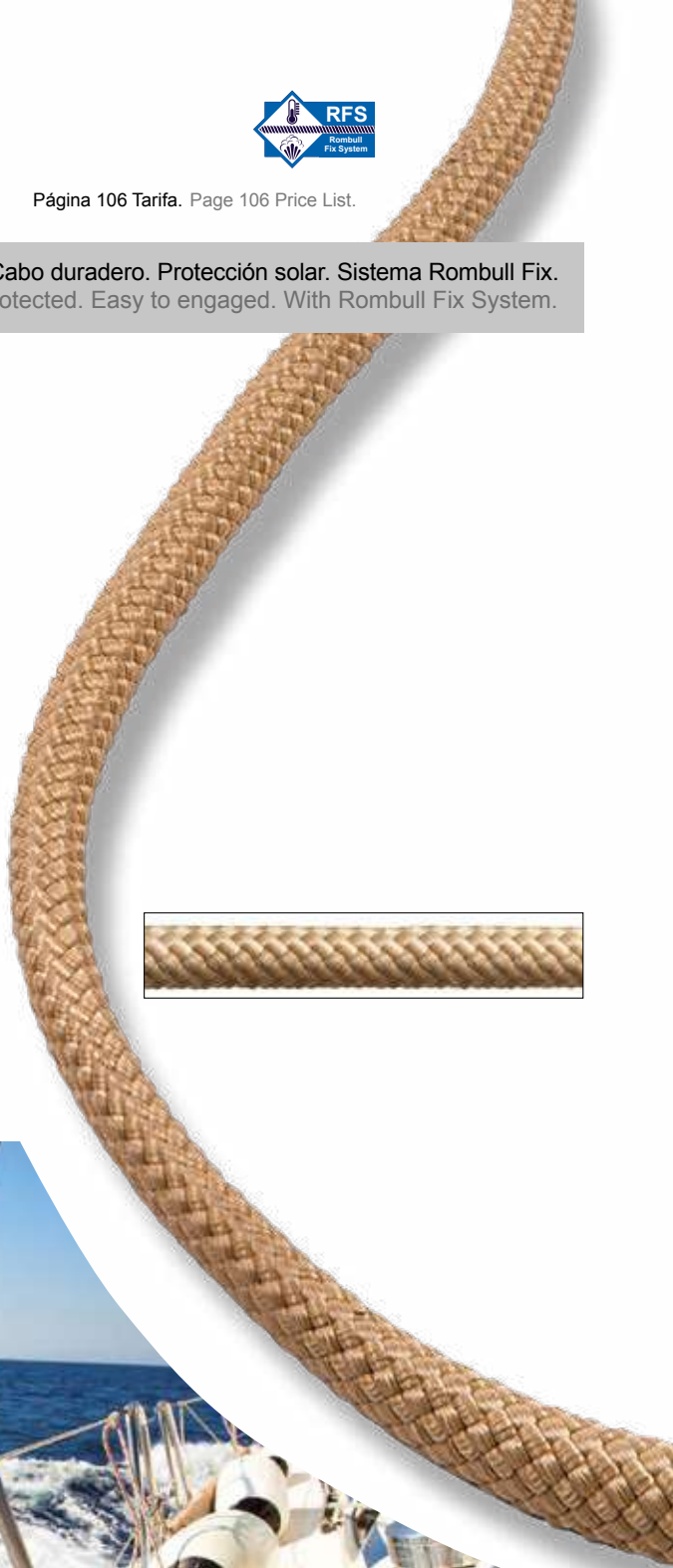



Grillete textil Rombull Novoleen

Novoleen shackle



Página 106 Tarifa. Page 106 Price List.

Grillete recubierto 100% PU. Con la misma carga de rotura que un grillete metálico. Uso seguro sin dañar, con tacto suave y agradable. Apertura y cierre sin la necesidad de herramientas. No se abren bajo carga.

100% PU-coated. With the same breaking load, this shackle is 10X lighter than a metal shackle. No damage will occur with its very soft and pleasant handling. Closing and opening without the need for tools. The rope shackles cannot be opened under load.



Sin protector
Without protector



Con protector
With protector

Diametro Diameter	Carga de trabajo Work load	Resistencia Resistance	Código Code	Blanco/Negro
55 mm	700 kg	1400 kg	PRODUCTO	612055000300
			EAN	8434035107038
65 mm	1500 kg	3000 kg	PRODUCTO	612065000300
			EAN	8434035107045
80 mm	2000 kg	4000 kg	PRODUCTO	612080000300
			EAN	8434035107052
85 mm	3500 kg	7000 kg	PRODUCTO	612085000300
			EAN	8434035107069
150 mm	4200 kg	8400 kg	PRODUCTO	612097000300
			EAN	8434035107076
170 mm	6000 kg	12000 kg	PRODUCTO	612098000300
			EAN	8434035107083

1 Grillete textil
Textile shackle

2 Protector resistente a la abrasión
Abrasion resistant protector



Cabo Rombull Cordino

Rombull Cordino strand

Cabo trenzado fabricado en multifilamentos de polipropileno alta tenacidad. Tratamiento de protección solar. No se deteriora en el agua. Por la diversidad de colores existe una fácil identificación de maniobra.

Twisted strand manufactured in high tenacity polypropylene multifilaments. Sun and water protected. Wide range of colours for an easy identification.

Grosor Thickness	Metros Meters	Resistencia Resistance	Código Code	Verde	Azul	Rojo	Amarillo	Blanco
3 mm	75 m	180 kg	PRODUCTO	607005005011	607005005022	607005005033	607005005055	607005005044
			EAN	8434035076341	8434035076358	8434035076365	8434035076372	8434035076389
4 mm	50 m	260 kg	PRODUCTO	607007001111	607007001122	607007001133	607007001155	607007001144
			EAN	8434035076396	8434035076402	8434035076419	8434035076426	8434035076433
6 mm	25 m	385 kg	PRODUCTO	607010002211	607010002222	607010002233	607010002255	607010002244
			EAN	8434035076440	8434035076457	8434035076464	8434035076471	8434035076488



Cordón Rombull Rainbow

Rainbow cord Rombull

► Ud. Cordón fantasía PES 2,5 mm/100 mtl

Grosor / Thickness **2,5 mm** Resistencia / Breaking load **193 kg** Carga trabajo / Work load **57,9 kg**



		Código	60 m - 240 g	100 m - 420 g
Negro	PRODUCTO	627404006766	627004000966	
	EAN	8434035078185	8434035078017	
Naranja flúor	PRODUCTO	627404006770	627004000970	
	EAN	8434035078192	8434035078062	
Amarillo flúor	PRODUCTO	627404006750	627004000950	
	EAN	8434035078093	8434035078079	
Verde flúor	PRODUCTO	627404006710	627004000910	
	EAN	8434035078109	8434035078000	
Azul	PRODUCTO	627404006722	627004000922	
	EAN	8434035078123	8434035078031	
Rojo	PRODUCTO	627404006733	627004000933	
	EAN	8434035078086	8434035078048	
Amarillo	PRODUCTO	627404006755	627004000955	
	EAN	8434035078208	8434035078055	
Verde	PRODUCTO	627404006711	627004000911	
	EAN	8434035078116	8434035078024	

► Ud. Cordón fantasía PES 3mm

Grosor / Thickness **3 mm** Resistencia / Breaking load **260 kg** Carga trabajo / Work load **78 kg**



		Código	50 m - 260 g	90 m - 260 g
Negro	PRODUCTO	627405001166	627005008866	
	EAN	8434035078260	8434035078321	
Naranja flúor	PRODUCTO	627405001170	627405008870	
	EAN	8434035078468	8434035078338	
Amarillo flúor	PRODUCTO	627405001150	627405008850	
	EAN	8434035078246	8434035078314	
Verde flúor	PRODUCTO	627405001110	627405008810	
	EAN	8434035078239	8434035078307	
Azul	PRODUCTO	627405001122	627405008822	
	EAN	8434035078215	8434035078284	
Rojo	PRODUCTO	627405001133	627405008833	
	EAN	8434035078253	8434035078475	
Amarillo	PRODUCTO	627405001155	627405008855	
	EAN	8434035078277	8434035078345	
Verde	PRODUCTO	627405001111	627405008811	
	EAN	8434035078222	8434035078291	



Cordón Rombull Rainbow

Rainbow cord Rombull

► Ud. Cordón fantasía PES 4mm

Grosor / Thickness **4 mm** Resistencia / Breaking load **330 kg** Carga trabajo / Work load **99 kg**



	Código	25 m - 280 g	60 m - 560 g
Negro	PRODUCTO	627407002266	627407006766
	EAN	8434035078130	8434035078420
Naranja flúor	PRODUCTO	627407002270	627407006770
	EAN	8434035078369	8434035078444
Amarillo flúor	PRODUCTO	627407002250	627407006750
	EAN	8434035078154	8434035078406
Verde flúor	PRODUCTO	627407002210	627407006710
	EAN	8434035078352	8434035078437
Azul	PRODUCTO	627407002222	627407006722
	EAN	8434035078147	8434035078413
Rojo	PRODUCTO	627407002233	627407006733
	EAN	8434035078161	8434035078390
Amarillo	PRODUCTO	627407002255	627407006755
	EAN	8434035078376	8434035078451
Verde	PRODUCTO	627407002211	627407006711
	EAN	8434035078178	8434035078383

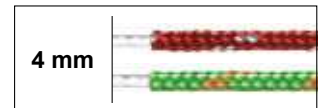

Accesorios elásticos

Elastic accessories

Cuerdas elásticas de gran resistencia y duración, ideal para sujetar diversos objetos de embarcaciones. Los finales de estos elásticos pueden ser con botón en madera, mosquetón de plástico, con final en bola o con gancho de plástico.

Elastic ropes of great resistance and durability, ideal for holding various objects of boats. Ending with button in wood, plastic carabiner, ball ending or plastic hook.



▶ BL. Elástico 6mm 60cm botón en madera

Código		
3 Ud. Pack	PRODUCTO	701110003100
	EAN	8434035082656



▶ BL. Elástico 8mm 80cm mosquetón plástico

Código		
2 Ud. Pack	PRODUCTO	704112003000
	EAN	8434035082649



▶ BL. Elástico 4mm 50cm final en bola

Código		
3 Ud. Pack	PRODUCTO	701107003400
	EAN	8434035082724



▶ BL. Elástico 4mm 35cm gancho de plástico

Código		
3 Ud. Pack	PRODUCTO	701107003500
	EAN	8434035082731



PULPOS, REDES ELÁSTICAS Y CORREAS DE AMARRE

STRECH CORDS, TIE-DOWN STRAPS & ELASTIC NETS





ROMBULL

Trincajes

Tie-down straps

► Información de la etiqueta interior cosida al producto Information contained sewed inside the tie down

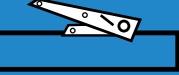
Material (etiqueta azul: PES) Material (blue label: PES)	LC 2000 daN PES	SECTION A	LC: Carga máxima de amarre LC: Lashing capacity (MAX)
Año de producción Production year	2018 EN 12195-2		Fabricado de acuerdo a la norma EN-1295-2 Logo produced conform EN-12195-2
Logo TUV TUV logo		SECTION B	Logo producción conforme a la norma EN-1295-2 Logo produced conform EN-12195-2
Año de producción Production year	EUROPEAN NORM 12195-2 2018		Elongación de un 7% cuando soporta su carga máxima Stretch max 7% when used on max LC
Material Material	PES		
Longitud del artículo Length of article	- Dehnung/ Stretch/ Rek/ Elasticité/ Elasticidad : max 7% - Länge/Length/Lengte/Longueur/Longitud : 7,50 M.		
No apto para elevar objetos Not for lifting: it's forbidden to use a tie down for lifting	- NICHT HEBEN, NUR ZURREN ! NOT FOR LIFTING! NIET GESCHIKT VOOR HIJSEN! PAS QUALIFÉ POUR HISSER! NO ELEVAR!		STF: Estándar de tensión (Tensión de la cinta cuando se alcanza la carga máxima en el trincaje) STF: Standard Tension Force (Tension of the webbing when the max force on the ratchet is reached)
SHF: Estándar de carga manual (Fuerza máxima que puedes aplicar con la mano en el trincaje) SHF: Standard Hand Force (Max force you can use with the hand on the ratchet)	SHF : 50 daN STF : 300 daN		
LC Usado en bucle LC used loop	LC: 1000 daN  LC: 2000 daN 		LC Usado recto LC used straight

► Acabados Finishes

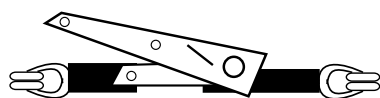

Gancho en J
J-Hook

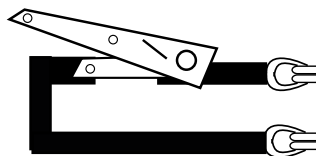

Cinta con ganchos
Strap with hooks

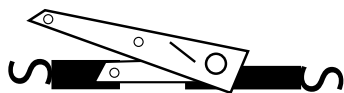

Gancho en S
S-Hook

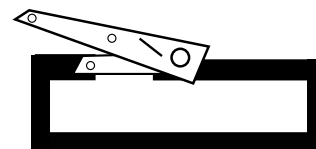

Cinta sin fin
Endless strap

Pulpo strong

Strong bungee

DESCRIPCIÓN: Cuerda elástica, exterior hilo de polipropileno, interior caucho natural. Gancho compuesto de acero cubierto de polímero de poliamida.

DESCRIPTION: Elastic rope, propylene exterior yarn, natural interior rubber. Hook made of steel recovered by PA polymer.



► BL. 2 uds. Pulpo 9mm/60cm negro p/roja c/gancho fuerte

Grosor / Thickness	9 mm	Longitud / Length	60 cm	Resistencia / Breaking load	110 kg
--------------------	------	-------------------	-------	-----------------------------	--------

Código	
Negro	PRODUCTO 701113000536
	EAN 8436019949573



► BL. 2 uds. Pulpo 9mm/80cm negro p/roja c/gancho fuerte

Grosor / Thickness	9 mm	Longitud / Length	80 cm	Resistencia / Breaking load	110 kg
--------------------	------	-------------------	-------	-----------------------------	--------

Código	
Negro	PRODUCTO 701113000836
	EAN 8436019949597



► BL. 2 uds. Pulpo 9mm/100cm negro p/roja c/gancho fuerte

Grosor / Thickness	9 mm	Longitud / Length	100 cm	Resistencia / Breaking load	110 kg
--------------------	------	-------------------	--------	-----------------------------	--------

Código	
Negro	PRODUCTO 701113000636
	EAN 8436019949580



GANCHO DE ACERO RECUBIERTO DE POLÍMERO DE POLIAMIDA

Otras medidas y presentaciones consúltenos, nos adaptamos a sus necesidades, somos fabricantes. En los pesos y resistencias de la cordelería puede existir una variación de +/-5%.

STEEL HOOK COATED WITH POLYAMIDE POLYMER

For other sizes and presentations please contact us. We adapt to your needs, we are manufactures. There might be a variation of +/-5% in the weight and resistance of ropes.



Pulpo medium

Medium bungee

DESCRIPCIÓN: Cuerda elástica, exterior hilo de polipropileno, interior caucho natural. Gancho compuesto de acero cubierto de polímero de poliamida.

DESCRIPTION: Elastic rope, propylene exterior yarn, natural interior rubber. Hook made of steel recovered by PA polymer.



▶ BL. 2 uds. Pulpo 8mm/60cm negro p/azul c/gancho

Grosor / Thickness	8 mm	Longitud / Length	60 cm	Resistencia / Breaking load	55 kg
--------------------	------	-------------------	-------	-----------------------------	-------

Código		
Negro	PRODUCTO	701112000526
	EAN	8434035066694



▶ BL. 2 uds. Pulpo 8mm/80cm negro p/azul c/gancho

Grosor / Thickness	8 mm	Longitud / Length	80 cm	Resistencia / Breaking load	55 kg
--------------------	------	-------------------	-------	-----------------------------	-------

Código		
Negro	PRODUCTO	701112000626
	EAN	8434035066700



▶ BL. 2 uds. Pulpo 8mm/100cm negro p/azul c/gancho

Grosor / Thickness	8 mm	Longitud / Length	100 cm	Resistencia / Breaking load	55 kg
--------------------	------	-------------------	--------	-----------------------------	-------

Código		
Negro	PRODUCTO	701112000726
	EAN	8434035066717



GANCHO DE ACERO RECUBIERTO DE POLÍMERO DE POLIAMIDA

Otras medidas y presentaciones consúltenos, nos adaptamos a sus necesidades, somos fabricantes. En los pesos y resistencias de la cordelería puede existir una variación de +/-5%.

STEEL HOOK COATED WITH POLYAMIDE POLYMER

For other sizes and presentations please contact us. We adapt to your needs, we are manufactures. There might be a variation of +/-5% in the weight and resistance of ropes.



Pulpo ajustable

Adjustable canopy ties

Página 111 Tarifa. Page 111 Price List.

DESCRIPCIÓN: Cuerda elástica, exterior hilo de polipropileno, interior caucho natural. Gancho plástico.
DESCRIPTION: Elastic rope, propylene exterior yarn, natural interior rubber. Plastic hook.



► BL. 2 uds. Pulpo ajustable en lazo 5mm/50cm

Grosor / Thickness **5 mm** Longitud / Length **50 cm**

Código		
Negro	PRODUCTO	701109001316
	EAN	8434035066687



► BL. 2 uds. Pulpo 8mm/100cm negro p.verde ajustable c/gancho

Grosor / Thickness **8 mm** Longitud / Length **100 cm** Resistencia / Breaking load **40 kg**



Código		
Negro	PRODUCTO	701109001016
	EAN	8434035066762



Pulpo plano

Bungee with adjustable hook

Página 111 Tarifa. Page 111 Price List.

DESCRIPCIÓN: Cuerda elástica, exterior hilo de polipropileno, interior caucho natural. Gancho compuesto de acero cubierto de polímero de poliamida.
DESCRIPTION: Elastic rope, propylene exterior yarn, natural interior rubber. Hook made of steel recovered by PA polymer.



ELÁSTICO PLANO
FLAT ELASTIC

► Ud. Pulpo plano 18mm/80cm c/gancho negro

Grosor / Thickness **18 mm** Longitud / Length **80 cm** Resistencia / Breaking load **80 kg**



Código		
Negro	PRODUCTO	701199000966
	EAN	8434035066755

GANCHO ACERO RECUBIERTO
DE POLÍMERO DE POLIAMIDA
STEEL HOOK COATED
WITH POLYAMIDE POLYMER



ELÁSTICO PLANO
FLAT ELASTIC

► Ud. Pulpo plano 9mm/60cm c/gancho

Grosor / Thickness **9 mm** Longitud / Length **60 cm** Resistencia / Breaking load **55 kg**



Código		
Negro	PRODUCTO	701199001226
	EAN	8434035066786

GANCHO ACERO RECUBIERTO
DE POLÍMERO DE POLIAMIDA
STEEL HOOK COATED
WITH POLYAMIDE POLYMER



Redes elásticas

Elastics nets

DESCRIPCIÓN: Red de polipropileno. Cuerda elástica, exterior hilo de polipropileno, interior caucho natural. Gancho plástico.
DESCRIPTION: Polypropylene Net. Elastic rope, propylene exterior yarn, natural rubber interior. Plastic hook.



► Ud. Red elástica motocicleta negra

Medida / Measure **17x22 cm**

Código

Negro	PRODUCTO	703100002766
	EAN	8434035066854

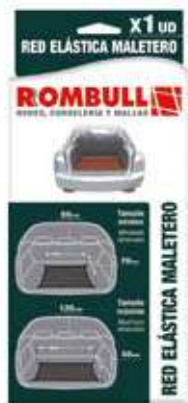
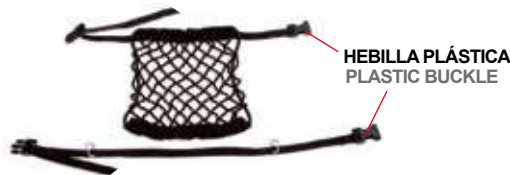

► Ud. Red elástica maletero negro c/gancho

Tamaño máximo y mínimo / Max. & min. dimension **120x50 cm - 80x70 cm**

Código

Negro	PRODUCTO	703100002469
	EAN	8434035066823



► Ud. Red elástica remolque negra

Tamaño GRANDE

Tamaño máximo / Max. dimension **135x230 cm**

Tamaño mínimo / Min. dimension **124x191 cm**

Código

Negro	PRODUCTO	703100002666
	EAN	8434035066847

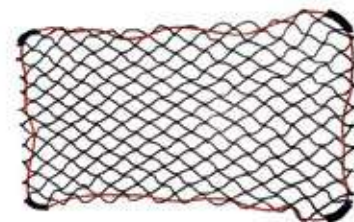

Tamaño PEQUEÑO

Tamaño máximo / Max. dimension **120x160 cm**

Tamaño mínimo / Min. dimension **105x150 cm**

Código

Negro	PRODUCTO	703100002566
	EAN	8434035066830

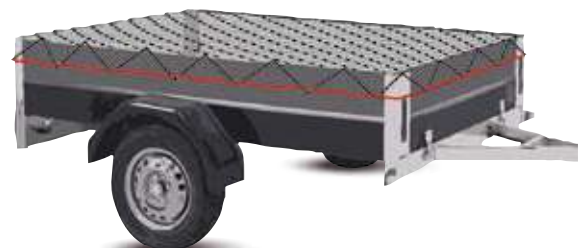

Trincaje

Tie-down straps



▶ BL. 2 uds. Trincaje ajustable cinta 25mm/2m negro c/gancho

DESCRIPCIÓN: Cincha de poliéster. Trincaje zamak. Ganchos de acero cubierto de plástico.
DESCRIPTION: Polyester webbing. Zamak Ratchet. "S" Steel hooks recovered by plastic.

Grosor / Thickness **25 mm** Longitud / Length **2 m** Resistencia / Breaking load **230 kg**

Código

Negro	PRODUCTO	702100002366
	EAN	8434035066816

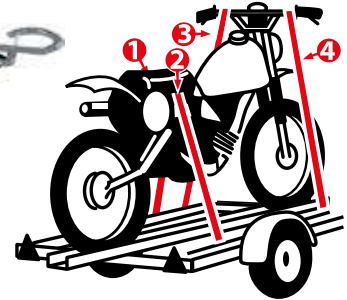

▶ Pk. Pulpos 4mm (2x25cm) y 8mm (2x45cm, 1x60cm y 1x80cm)

DESCRIPCIÓN: Cuerda elástica, exterior hilo de polipropileno, interior caucho natural. Gancho de acero recubierto de polímero de poliamida.

DESCRIPTION: Elastic rope, propylene exterior yarn, interior natural rubber. Steel hook coated with polyamide polymer.

Código

Negro	PRODUCTO	701199001166
	EAN	8434035066779



2 ud.	Grosor / Thickness 4 mm	Longitud / Length 25 m	
2 ud.	Grosor / Thickness 8 mm	Longitud / Length 45 m	Resistencia / Breaking load 55 Kg
1 ud.	Grosor / Thickness 8 mm	Longitud / Length 60 m	Resistencia / Breaking load 55 Kg
1 ud.	Grosor / Thickness 8 mm	Longitud / Length 80 m	Resistencia / Breaking load 55 Kg

GANCHO ACERO RECUBIERTO DE POLÍMERO DE POLIAMIDA

STEEL HOOK COATED WITH POLYAMIDE POLYMER





► Ud. Trincaje GSV PPM 25mm/5m azul

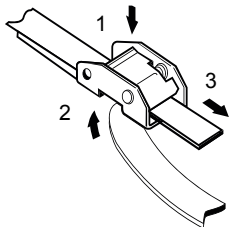

DESCRIPCIÓN: Trincaje fabricado en cinta de polipropileno de 25 mm de grosor y 5 m de largo, con hebilla recubierta de polímero para un agarre ergonómico.

DESCRIPTION: Tie down with a strap of 25 mm thickness and 5 m length made of PPM, with a buckle coated with polymer which is more user friendly due to its soft grip.

Grosor / Thickness **25 mm** Longitud / Length **5 m** Resistencia / Breaking load **600 kg**



1 Ud. Código

Azul	PRODUCTO	702392054922
	EAN	8434035117242

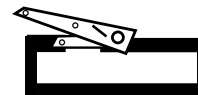

► Ud. Trincaje PES 25mm/5m - ganchos S



DESCRIPCIÓN: Trincaje fabricado en cinta de poliéster de 25 mm de grosor y 5 m de largo, con ganchos acabados en S y hebilla recubierta de polímero para un agarre ergonómico.

DESCRIPTION: Tie down with a strap of 25 mm thickness and 5 m length made of PES, with S-hooks to fix safely. Buckle coated with polymer which is more user friendly due to its soft grip.

Grosor / Thickness **25 mm** Longitud / Length **5 m** Resistencia / Breaking load **600 kg**



1 Ud. Código

Negro	PRODUCTO	702393054866
	EAN	8434035117266

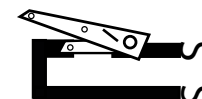
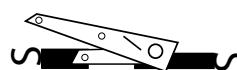

Pulpos goma elástica

Elastic bungee cord

► Ud. Pulpo goma elástica 8mm/1mtl



Pulpo

Grosor / Thickness	8 mm	Longitud / Length	1 m	Peso / Weight	95 g
--------------------	-------------	-------------------	------------	---------------	-------------

Código

Verde	PRODUCTO	498012008711
	EAN	8434035056190

Azul	PRODUCTO	498012008722
	EAN	8434035056206

► Ud. Pulpo goma elástica 8mm/1,5mtl



Pulpo

Grosor / Thickness	8 mm	Longitud / Length	1,5 m	Peso / Weight	116 g
--------------------	-------------	-------------------	--------------	---------------	--------------

Código

Verde	PRODUCTO	498012006911
	EAN	8434035056176

Azul	PRODUCTO	498012006922
	EAN	8434035056183

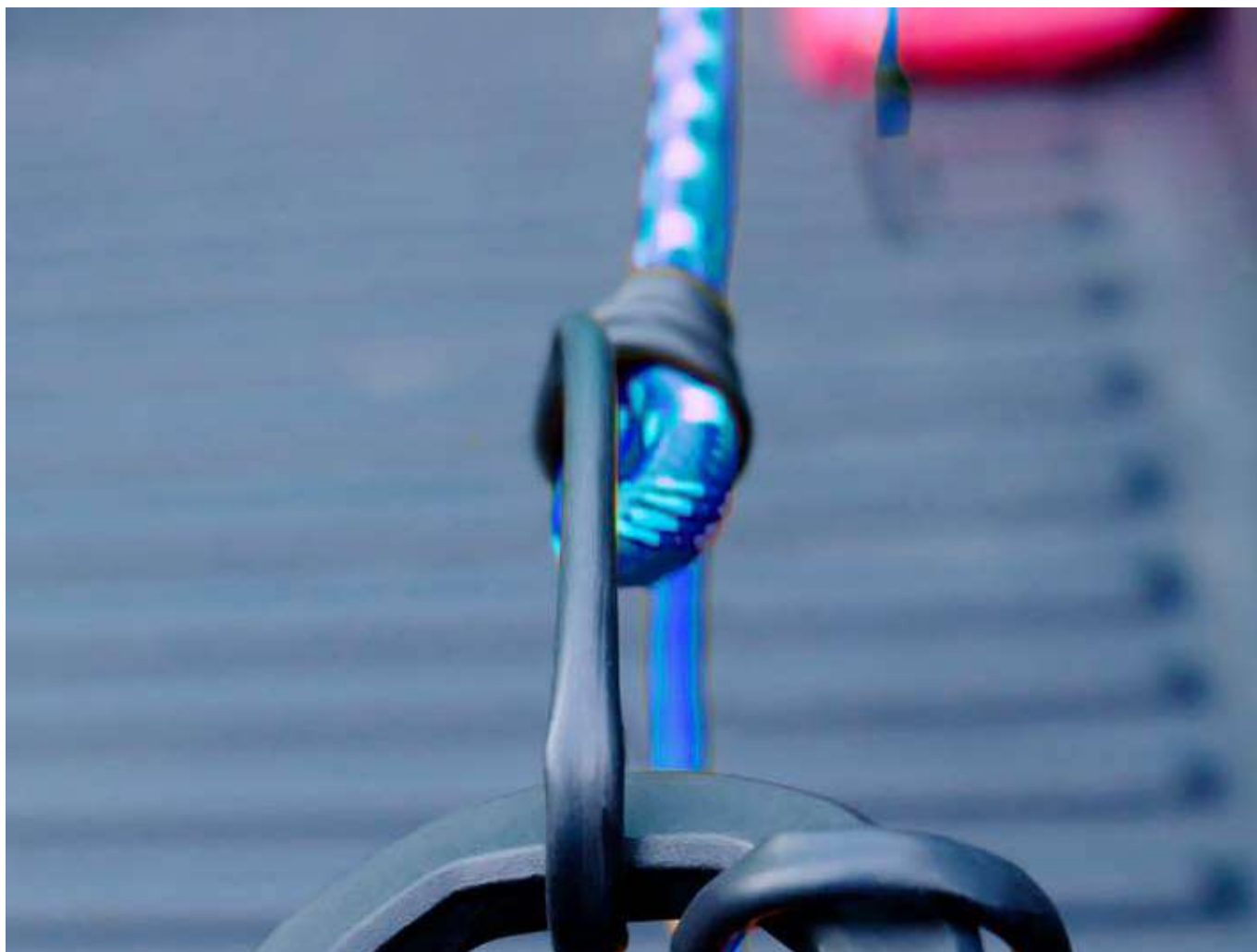

Trincaje

Tie-down straps

► Ud. Trincaje GSV PES 25mm/5m



DESCRIPCIÓN: Trincaje fabricado en cinta de PES de 25 mm de grosor y 5 m de largo con carraca recubierta de polímero.

DESCRIPTION: Tie down with a strap of 25 mm thickness and 5 m length made of PES, with a coated polymer ratchet.

Grosor / Thickness **25 mm** Longitud / Length **5 m** Resistencia / Breaking load **600 kg**



1 Ud. Código

Azul	PRODUCTO	702392055022
	EAN	8434035117549

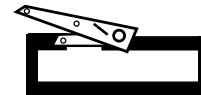

► Ud. Trincaje PES 25mm/5m ganchos S



DESCRIPCIÓN: 2 Piezas fabricadas en cinta de PES de 25 mm de grosor y 5 m de largo, con trincaje recubierto de polímero y 2 terminaciones es S.

DESCRIPTION: Tie down of 2 pieces with a strap of 25 mm thickness and 5 m length made of PES, with a coated polymer ratchet. It ends with 2 S-hooks.

Grosor / Thickness **25 mm** Longitud / Length **5 m** Resistencia / Breaking load **600 kg**



1 Ud. Código

Azul	PRODUCTO	702393055222
	EAN	8434035117365



► Ud. Trincaje PES 25mm/5m ganchos J



DESCRIPCIÓN: 2 piezas fabricadas en cinta de PES de 25 mm de grosor y 5 m de largo, con trincaje recubierto de polímero y 2 terminaciones en J.

DESCRIPTION: Tie down of 2 pieces with a strap of 25 mm thickness and 5 m length made of PES, with a coated polymer ratchet. It ends with 2 J-hooks.

Grosor / Thickness **25 mm** Longitud / Length **5 m** Resistencia / Breaking load **600 kg**



1 Ud. Código

Azul	PRODUCTO	702391055322
	EAN	8434035117389

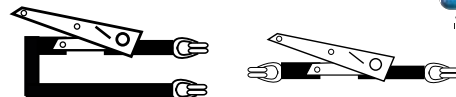

Trincaje profesional

Profesional tie-down straps

► Ud. Trincaje PES 35mm/6m



DESCRIPCIÓN: Trincaje con carraca fabricada en cinta de PES de 35 mm de grosor y 6 m de largo.
DESCRIPTION: Tie down with a strap of 35 mm thickness and 6 m length made of PES and a endless moulded ratchet.

Grosor / Thickness **35 mm** Longitud / Length **6 m** Resistencia / Breaking load **2000 kg**

1 Ud. Código

Naranja Flúor	PRODUCTO	702384055477
	EAN	8434035117402

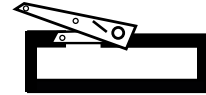

► Ud. Trincaje PES 35mm/6m ganchos J



DESCRIPCIÓN: Trincaje con carraca fabricada en cinta de PES de 35 mm de grosor y 6 m de largo con 2 ganchos terminados en J.

DESCRIPTION: Tie down of 2 pieces with a strap of 35 mm thickness and 6 m length made of PES and a moulded ratchet. It ends with 2 J-hooks.

Grosor / Thickness **35 mm** Longitud / Length **6 m** Resistencia / Breaking load **2000 kg**

1 Ud. Código

Naranja Flúor	PRODUCTO	702381055633
	EAN	8434035117426

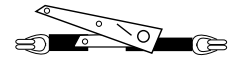
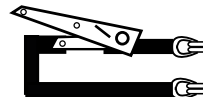

Trincaje profesional

Professional tie-down straps

► Ud. Trincaje PES 50mm/8m



DESCRIPCIÓN: Trincaje con carraca, cinta fabricada en PES de 50 mm de grosor y 8 m de largo.
DESCRIPTION: Endless tie down with a strap of 50 mm thickness and 8 m length made of PES and a 23 cm ratchet.

Grosor / Thickness 50 mm Longitud / Length 8 m Resistencia / Breaking load 4000 kg

Código

Rojo	PRODUCTO	702384054533
	EAN	8434035117440

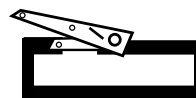

► Ud. Trincaje PES 50mm/9m ganchos J



DESCRIPCIÓN: Trincaje con carraca, cinta fabricada en PES de 50 mm de grosor y 9 m de largo con 2 ganchos terminados en J.
DESCRIPTION: Tie down with a strap of 50 mm thickness and 9 m length made of PES and a 23 cm ratchet. It ends with 2 J-hooks.

Grosor / Thickness 50 mm Longitud / Length 9 m Resistencia / Breaking load 5000 kg

Código

Rojo	PRODUCTO	702381054633
	EAN	8434035117457

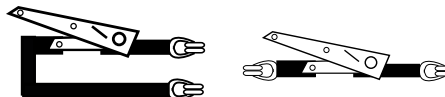

► Ud. Trincaje Ergo 50mm/8m STF 500



DESCRIPCIÓN: Trincaje con carraca ergonómica y cinta fabricada en PES de 50 mm de grosor y 8 m de largo.
DESCRIPCIÓN: Tie down with an ergonomic 33 cm ratchet and a strap of 50 mm thickness and 8 m length made of PES.

Grosor / Thickness 50 mm Longitud / Length 8 m Resistencia / Breaking load 5000 kg

Código

Rojo	PRODUCTO	702384057733
	EAN	8434035128767

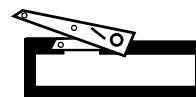

► Ud. Trincaje Ergo 50mm/9m ganchos J STF 500



DESCRIPCIÓN: Trincaje con carraca ergonómica y cinta fabricada en PES de 50 mm de grosor y 9 m de largo con 2 ganchos terminados en J.
DESCRIPTION: Tie down with an ergonomic 33 cm ratchet and a strap of 50 mm thickness and 9 m length made of PES. It ends with 2 J-hooks.

Grosor / Thickness 50 mm Longitud / Length 9 m Resistencia / Breaking load 5000 kg

Código

Rojo	PRODUCTO	702381054733
	EAN	8434035117464

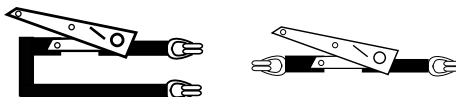

Cajas dispensadoras

Dispensing boxes



► Ud. Caja dispensadora trincaje

DESCRIPCIÓN: Caja dispensadora de trincajes fabricados en cinta de PPM de 25 mm de grosor y 4 m de largo, con carraca de zinc y ganchos acabados en S. La caja incluye 4 trincajes con ganchos acabados en S y 8 trincajes sin fin.

DESCRIPTION: Dispensing box of tie downs with a straps of 25 mm thickness and 4 m length made of PPM. They have a zinc ratchet and S-hooks. The box includes 4 tie downs with end S-hooks and 8 endless tie downs.

Grosor / Thickness	25 mm	Longitud / Length	4 m	Resistencia / Breaking load	250 kg
--------------------	-------	-------------------	-----	-----------------------------	--------

Código		
Verde	PRODUCTO	702393084410
	EAN	8434035117501



► Ud. Caja dispensadora GSV

DESCRIPCIÓN: Caja dispensadora de GSV fabricados en cinta de PPM de 25 mm de grosor con diferentes longitudes y colores.

DESCRIPTION: Dispensing box of GSV with a straps of 25 mm thickness with different lengths and colors made of PPM.



Color Color	Longitud Length	Unidades Units	Grosor Thickness	Resistencia Resistance
Amarillo	50 cm	7	25 mm	250 kg
Negro	100 cm	5	25 mm	250 kg
Azul	200 cm	4	25 mm	250 kg
Naranja	250 cm	8	25 mm	250 kg
Verde	300 cm	3	25 mm	250 kg

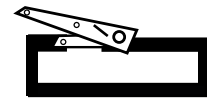

Código	
PRODUCTO	702392086399
EAN	8434035117310



CABLES, CADENAS Y ACCESORIOS

CHAINS, WIRE ROPES AND ACCESSORIES



ROMBULL

Cables

Wire ropes

Cables torcidos: Varios cordones de alambres trefilados se giran en espiral alrededor de un inserto.

Twisted (pounded) wire ropes: A variety of braids from pulled wires are twisted in a spiral shape around a core.

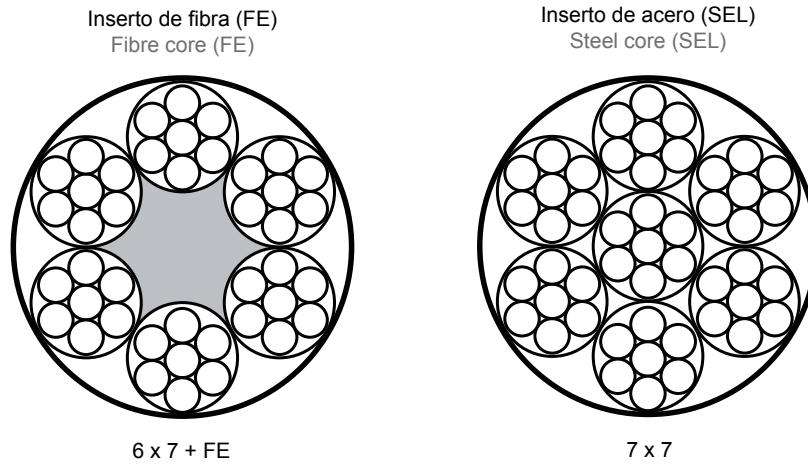

La flexibilidad de un cable con el mismo diámetro y la misma resistencia depende de la cantidad de alambres utilizados.

Por. ej. $6 \times 7 = 6$ cordones, cada uno con 7 alambres = 42 alambres - más rígido.

$7 \times 7 = 7$ cordones, cada uno con 7 alambres = 49 alambres - más flexible.

Para cables del mismo diámetro y calidad, cuanto más blando sea el cable, más alambres se utilizarán y más delgado será el alambre individual.

Los insertos de fibra son hilados trenzados de fibra natural o química y forman la base de diseño para los cables.

- **Conexiones finales:** Un guardacabos ayuda a garantizar los radios de seguridad prescritos y evita la abrasión. Para garantizar la seguridad, utilice siempre 3 abrazaderas de cable. La horquilla de las abrazaderas debe colgar en el extremo que no tiene carga.
- **Conexión longitudinal:** Para garantizar la seguridad, se deben usar al menos 5 abrazaderas de cable.

The flexibility of a wire rope with the same diameter and strength depends on the number of wires used.

E. g. $6 \times 7 = 6$ braids each with 7 strands = 42 wires - stiffer.

$7 \times 7 = 7$ braids each with 7 strands = 49 wires - more flexible.

For ropes with the same diameter and of the same quality, the softer the rope, the more wires are used and the thinner each individual wire.

Fibre cores are stranded natural or synthetic fibre twines and form the construction basis for the wire ropes.

- **End connections:** A thimble helps ensure the prescribed safety radii and prevents wear. To ensure safety, 3 wire rope clamps must always be used. The wire rope clamp bracket must hang on the unloaded end. Wire rope clamp bracket Unloaded end thimble.
- **Longitudinal connection:** To ensure safety, at least 5 rope clamps should be used.

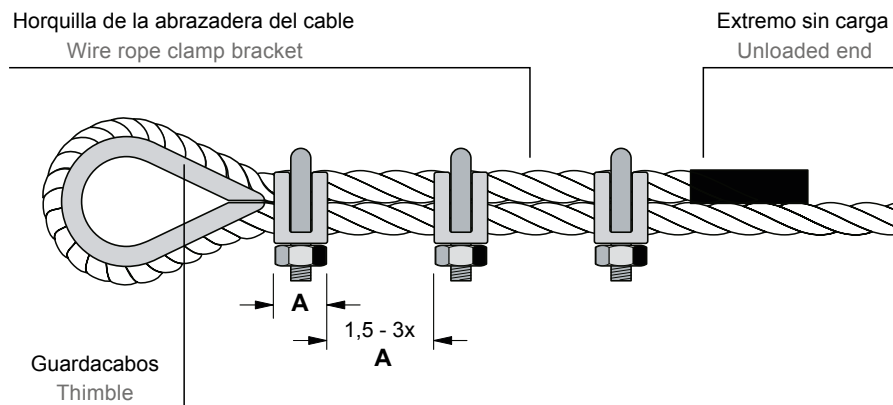

Cable de acero

Steel wire ropes

Cable de acero cincado, trenzado con 6 cables con 7 filamentos.
Alta capacidad de carga y resistencia a la abrasión.

Steel wire rope, galvanized, of 6 braids each with 7 strands. High load capacity and resistance to abrasion.



6x7 FE

► Ud. Cable de acero cincado - Precortado



D Ø	Longitud Length	Cód. producto Product code	Cód. EAN EAN code	Resistencia Breaking load	Carga trabajo Load capacity
2 mm	10 m	820202026160	8434035118140	235 daN	45 kg
2 mm	30 m	820202026190	8434035121041	235 daN	45 kg
3 mm	10 m	820202056160	8434035118157	529 daN	105 kg
3 mm	20 m	820202056180	8434035121058	529 daN	105 kg
4 mm	10 m	820202076160	8434035118164	940 daN	185 kg
4 mm	20 m	820202076180	8434035121065	940 daN	185 kg
5 mm	10 m	820202096160	8434035118171	1470 daN	290 kg

► Ud. Cable de acero cincado - Al corte



D Ø	Longitud Length	Cód. producto Product code	Cód. EAN EAN code	Resistencia Breaking load	Carga trabajo Load capacity
1,5 mm	500 m	820202011150	8434035121195	100 daN	20 kg
2 mm	300 m	820202021190	8434035121201	235 daN	45 kg
3 mm	500 m	820202051150	8434035121218	529 daN	105 kg
3 mm	250 m	820202051290	8434035121225	529 daN	105 kg
4 mm	250 m	820202071290	8434035121232	940 daN	185 kg
5 mm	150 m	820202091410	8434035121249	1470 daN	290 kg
6 mm	100 m	820202101090	8434035121256	2120 daN	420 kg
8 mm	50 m	820202121110	8434035121263	3480 daN	695 kg

Cable de acero inoxidable

Stainless steel wire ropes

Cable de acero inoxidable, trenzado con 7 cables con 7 filamentos.
Alta capacidad de carga y resistencia a la abrasión.

Stainless steel wire rope of 7 braids, each with 7 strands. High load capacity and resistance to abrasion.



INOX

7x7

► Ud. Cable de acero inoxidable - Precortado



D Ø	Longitud Length	Cód. producto Product code	Cód. EAN EAN code	Resistencia Breaking load	Carga trabajo Load capacity	Acero inox. Stainless steel
2 mm	10 m	820201026160	8434035118126	250 daN	50 kg	ACERO INOX
2 mm	20 m	820201026180	8434035118188	250 daN	50 kg	ACERO INOX
3 mm	10 m	820201056160	8434035118195	570 daN	110 kg	ACERO INOX
3 mm	20 m	820201056180	8434035120990	570 daN	110 kg	ACERO INOX
4 mm	10 m	820201076160	8434035118133	1070 daN	210 kg	ACERO INOX
4 mm	20 m	820201076180	8434035121003	1070 daN	210 kg	ACERO INOX

► Ud. Cable de acero inoxidable - Al corte



D Ø	Longitud Length	Cód. producto Product code	Cód. EAN EAN code	Resistencia Breaking load	Carga trabajo Load capacity	Acero inox. Stainless steel
2 mm	300 m	820201021330	8434035121072	250 daN	50 kg	ACERO INOX
3 mm	150 m	820201051410	8434035121089	570 daN	110 kg	ACERO INOX
4 mm	250 m	820201071290	8434035121096	1070 daN	210 kg	ACERO INOX
5 mm	150 m	820201091410	8434035121102	1520 daN	300 kg	ACERO INOX
6 mm	100 m	820201101090	8434035121119	2190 daN	435 kg	ACERO INOX

Todas las dimensiones y pesos indicados, especialmente las capacidades de carga, son valores teóricos. Antes de su uso, se debe de definir cual va a ser el propósito de estos artículos.
All dimensions and weights stated, especially load capacities, are theoretical values without obligation. The articles must be checked for their suitability for the purpose in mind before use.

Cable de acero plastificado

PVC coated steel wire ropes

Página 118 Tarifa. Page 118 Price List.

Cable de acero cincado revestido con PVC, trenzado con 6 cables con 7 filamentos.
Alta capacidad de carga y resistencia a la abrasión.

Steel wire rope, galvanized, PVC-coated, of 6 braids each with 7 strands.
High load capacity and resistance to abrasion.



6x7 FE

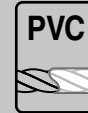

► Ud. Cable de acero cincado revestido con PVC - Precortado



D Ø	Longitud Length	Cód. producto Product code	Cód. EAN EAN code	Resistencia Breaking load	Carga trabajo Load capacity
2/3 mm	10 m	820302056160	8434035118089	235 daN	45 kg
2/3 mm	20 m	820302056180	8434035121010	235 daN	45 kg
3/4 mm	10 m	820302076160	8434035118096	529 daN	105 kg
3/4 mm	20 m	820302076180	8434035121027	529 daN	105 kg
4/5 mm	10 m	820302096160	8434035118102	940 daN	185 kg
4/5 mm	20 m	820302096180	8434035121034	940 daN	185 kg
5/6 mm	20 m	820302106180	8434035118119	1470 daN	290 kg

► Ud. Cable de acero cincado revestido con PVC - Al corte



D Ø	Longitud Length	Cód. producto Product code	Cód. EAN EAN code	Resistencia Breaking load	Carga trabajo Load capacity
2/3 mm	120 m	820302051380	8434035121126	235 daN	45 kg
3/4 mm	90 m	820302071880	8434035121133	529 daN	105 kg
4/5 mm	100 m	820302091090	8434035121140	940 daN	185 kg
4/5 mm	50 m	820302091110	8434035121157	940 daN	185 kg
5/6 mm	80 m	820302101260	8434035121164	1470 daN	290 kg
5/6 mm	40 m	820302101510	8434035121171	1470 daN	290 kg
6/8 mm	30 m	820302121190	8434035121188	2100 daN	420 kg

Alambre galvanizado

Galvanized steel wire

Página 119 Tarifa. Page 119 Price List.

► Ud. Alambre galvanizado



D Ø	Longitud Length	Cód. producto Product code	Cód. EAN EAN code
0,9 mm	70 m	815814033420	8434035130647
1,1 mm	47 m	815814053440	8434035130654
1,4 mm	29 m	815814083320	8434035130678

Alambre plastificado

Coated steel wire

Página 119 Tarifa. Page 119 Price List.

► Ud. Alambre plastificado



D Ø	Longitud Length	Cód. producto Product code	Cód. EAN EAN code	Color Color
1,6/2,6 mm	10 m	815815043164	8434035130685	Blanco
1,6/2,6 mm	10 m	815815043161	8434035130692	Verde

Todas las dimensiones y pesos indicados, especialmente las capacidades de carga, son valores teóricos. Antes de su uso, se debe de definir cual va a ser el propósito de estos artículos.
All dimensions and weights stated, especially load capacities, are theoretical values without obligation. The articles must be checked for their suitability for the purpose in mind before use.

Cadenas

Chains

► Cadenas de acero redondo Round-steel chains

DIN 5685

- **DIN 5685-1:** eslabón largo.
- **DIN 5685-2:** eslabón semilargo.
- **DIN 5685-3:** eslabón corto.

Estas normas se aplican a las cadenas de acero redondo soldadas para uso general sin prueba de carga.

• **Material:** acero.

• **Versión:** brillante, electro-galvanizado o galvanizado por inmersión en caliente.

Estas cadenas no deben usarse como dispositivos de elevación, sujeción o tracción. El uso de estas cadenas para suspender estáticamente cargas, son responsabilidad exclusiva del usuario, se estipularon valores calculados para un único filamento suspendido verticalmente.

• **DIN 5685-1 y -2:** Grosor de alambre 2-13 mm. Capacidad de carga estática calculada 20-800 kg.

• **DIN 5685-3:** Grosor alambre 4-16 mm. Capacidad de carga estática calculada 80-1250 kg. Dimensiones similares a DIN 766.

• **DIN 5685-1:** Long link.

• **DIN 5685-2:** Semi long link.

• **DIN 5685-3:** Short link.

These standards apply to welded round steel chains for general purposes without proof loading.

• **Material:** steel.

• **Finish:** bright, electro-galvanised or hot-dip galvanised.

These chains may not be used as load suspension devices, slinging equipment or load carrying means. For the permissible use of these chains for static suspension of loads lying in the sole sphere of responsibility of the user, calculated values were stipulated for the vertically suspended single strand.

• **DIN 5685-1 and -2:** Wire thickness 2-13 mm, calculated static load capacity 20-800 kg.

• **DIN 5685-3:** Wire thickness 4-16 mm, calculated static load capacity 80-1250 kg, dimensions similar to DIN 766.

DIN 766

Esta norma se aplica a las cadenas de acero redondo, de categoría de calidad 3, calibradas y especificadas sus dimensiones y propiedades mecánicas.

• **Material:** acero, calidad mínima Ust 35-2.

• **Versión:** brillante, electro-galvanizado o galvanizado por inmersión en caliente.

Estas cadenas se utilizan en todo el campo tecnológico y como herramienta de elevación manual; no obstante, no deben utilizarse para herramientas de elevación y sujeción accionadas por motor.

Grosor de alambre 4-16 mm, Capacidad de carga 200-3200 kg. Cadenas de nudos.

This standard applies to tested and calibrated round steel chains in grade 3 and defines their dimensions and mechanical properties.

• **Material:** steel, minimum grade Ust 35-2.

• **Finish:** bright, electro-galvanised or hot-dip galvanised.

These chains are used in the complete field of technology and as manual lifting tools, but may not be used for motor-driven lifting tools or as slinging equipment.

Wire thickness 4.0 - 16.0 mm, load capacity 200-3200 kg.

DIN 763

Esta norma se aplica a las cadenas de acero redondo y eslabón largo, probadas y no calibradas, define sus dimensiones y propiedades mecánicas.

• **Material:** acero.

• **Versión:** brillante o galvanizado.

Estas cadenas no deben usarse como dispositivos de elevación, sujeción o tracción.

Grosor de alambre 4-16 mm, Capacidad de carga para suspensiones estáticas 100-1600 kg.

This standard applies to long-link, tested and non-calibrated round steel chains and defines their dimensions and mechanical properties.

• **Material:** steel.

• **Finish:** bright or electro-galvanised.

These chains may not be used as load suspension devices, slinging equipment or load carrying means.

Wire thickness 4-16 mm, load capacity for static suspensions 100-1600 kg.

DIN 5686

Esta norma especifica las dimensiones de las cadenas de nudos sin requisitos de calidad en el rango de grosor nominal de 1 a 5,5 mm.

• **Material:** acero electro-galvanizado.

Estas cadenas no deben usarse como dispositivos de elevación, sujeción o tracción.

Grosor de alambre 1- 4,6 mm.

This standard defines the dimensions of knotted link chains without quality requirements in a nominal thickness range of 1 to 5,5 mm.

• **Material:** steel, electro-galvanised.

These chains may not be used as load suspension devices, slinging equipment or load carrying means. Wire thickness 1 to 4,6 mm.

► Cadenas de plástico Plastic chains

Las cadenas de plástico son resistentes a los rayos UV y al paso de automóviles. Son versátiles para delimitar, marcar y asegurar. No se prueba la resistencia de las cadenas de plástico y por lo tanto no se pueden someter a esfuerzos de tracción o flexión. Se pueden enviar en grosores de 6, 8 y 10 mm y en los colores rojo/ blanco, negro/amarillo, blanco, negro, rojo o cobre.

Plastic chains are UV-resistant and safe to be driven over by passenger cars. They have many different uses to rope off, mark and secure. Plastic chains are not tested for strength and may therefore not be subjected to tensile or bending forces. They can be delivered in the thicknesses 6, 8 and 10 mm and in the colours red/white, black/yellow, white, black, red or copper-coloured.

► Cadenas decorativas y de reloj Decorative and clock chains

Cadenas decorativas de perfil cuadrado o perfil redondo. Solo se puede usar con fines decorativos. Material: acero galvanizado o lacado. Varios colores y acabados. Hay disponibles accesorios y juegos de cadenas. Cadenas de reloj de acero o niqueladas.

Decorative chains of square wire or round wire. Use only for decorative purposes. Material: steel, galvanised or lacquered. Various colours and designs. Accessories and assembled chain sets are also available. Clock chains of steel or nickel-plated, galvanised.

► Accesorios Accessories

Dentro de nuestra gama de artículos, también encontrará una gran variedad de accesorios para cadenas y cuerdas en diferentes versiones; por ejemplo: Eslabón de acero y polietileno. Gancho en S de acero, anillos redondos de acero, mosquetones con o sin tornillo. Grilletes en diferentes materiales y versiones.

We also offer a wide variety of accessories for chains and ropes in various designs, e.g.: Quick links of steel and PE-Plastic. S-hooks of steel, rings of steel, snap hooks with or without screw. Shackles in various materials and designs.

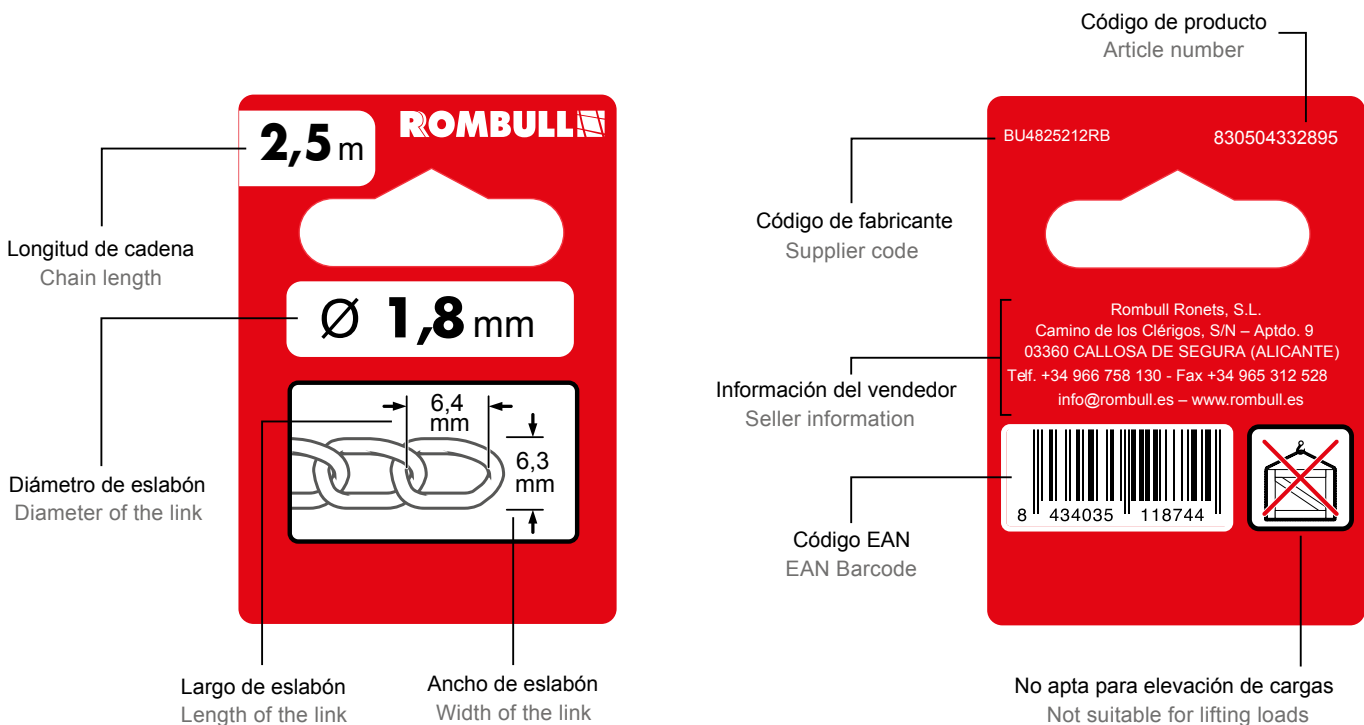

Cadena de acero DIN 5685-1

Round-steel chains DIN 5685-1

Página 119 Tarifa. Page 119 Price List.

Cadena de acero cincada, según la norma DIN 5685-1, con eslabones largos que aportan una gran resistencia y durabilidad.

Round steel chain, zinc-plated, DIN 5685-1. It has long links that grant great resistance and durability.



Cincada / Zinc-plated steel

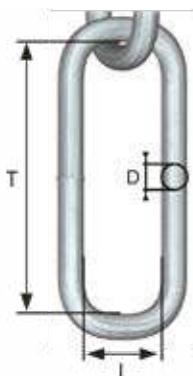

► Ud. Cadena de acero cincada DIN 5685-1 - Precortada

D Ø	T mm	l mm	Mtl Mtl	Carga trabajo Load capacity	Cód. producto Product code	Cód. EAN EAN code
2 mm	22 mm	3,5 mm	5 m	20 kg	830802022370	8434035118638
3 mm	26 mm	5,5 mm	5 m	40 kg	830802052370	8434035118645
4 mm	32 mm	7 mm	3 m	80 kg	830802072050	8434035118652
5 mm	35 mm	9 mm	2 m	125 kg	830802092040	8434035118669
6 mm	42 mm	11 mm	2 m	160 kg	830802102040	8434035120570



Cincada / Zinc-plated steel

► Ud. Carrete cadena de acero cincada DIN 5685-1 - Al corte



D Ø	T mm	l mm	Mtl Mtl	Carga trabajo Load capacity	Cód. producto Product code	Cód. EAN EAN code
2 mm	22 mm	3,5 mm	60 m	20 kg	830802021670	8434035120785
3 mm	26 mm	5,5 mm	30 m	40 kg	830802051190	8434035120792
4 mm	32 mm	7 mm	30 m	80 kg	830802071190	8434035120808
5 mm	35 mm	9 mm	30 m	125 kg	830802091190	8434035120815
6 mm	42 mm	11 mm	15 m	160 kg	830802101170	8434035120822
8 mm	52 mm	14 mm	10 m	320 kg	830802121160	8434035120839



Galvanizado a fuego / Hot dip galvanised



► Ud. Carrete cadena de acero galvanizado al fuego DIN 5685-1 - Al corte

D Ø	T mm	l mm	Mtl Mtl	Carga trabajo Load capacity	Cód. producto Product code	Cód. EAN EAN code
4 mm	32 mm	7 mm	30 m	80 kg	830803071190	8434035120877
6 mm	42 mm	11 mm	15 m	160 kg	830803101170	8434035120884

Todas las dimensiones y pesos indicados, especialmente las capacidades de carga, son valores teóricos. Antes de su uso, se debe de definir cual va a ser el propósito de estos artículos.
All dimensions and weights stated, especially load capacities, are theoretical values without obligation. The articles must be checked for their suitability for the purpose in mind before use.

Cadena de acero inoxidable

Stainless steel chains



Página 119 Tarifa. Page 119 Price List.

Cadena de acero inoxidable con eslabones largos que aportan una gran resistencia y durabilidad.
Stainless steel chain with long links that grant great resistance and durability.



Acero inoxidable / Stainless steel



► Ud. Cadena de acero inoxidable de eslabones largos - Precortada

D Ø	T mm	B mm	Mtl Mtl	Carga trabajo Load capacity	Cód. producto Product code	Cód. EAN EAN code	Acero inox. Stainless steel
3 mm	26 mm	12 mm	2,5 m	40 kg	830401052890	8434035120594	ACERO INOX
4 mm	32 mm	16,8 mm	2,5 m	80 kg	830401072890	8434035118799	ACERO INOX
4 mm	32 mm	16,8 mm	3 m	80 kg	830401072050	8434035120587	ACERO INOX



Acero inoxidable / Stainless steel

► Ud. Carrete cadena de acero inoxidable de eslabones largos - Al corte



D Ø	T mm	B mm	Mtl Mtl	Carga trabajo Load capacity	Cód. producto Product code	Cód. EAN EAN code	Acero inox. Stainless steel
2 mm	22 mm	8 mm	60 m	20 kg	832801021670	8434035120914	ACERO INOX
3 mm	26 mm	12 mm	30 m	40 kg	832801051190	8434035120921	ACERO INOX
4 mm	32 mm	16,8 mm	30 m	80 kg	832801071190	8434035120938	ACERO INOX
5 mm	35 mm	21 mm	30 m	125 kg	830401091190	8434035118898	ACERO INOX
6 mm	42 mm	25,2 mm	15 m	160 kg	832801101170	8434035120945	ACERO INOX



Acero inoxidable / Stainless steel

► Ud. Carrete cadena de acero inoxidable de eslabones semilargos - Al corte

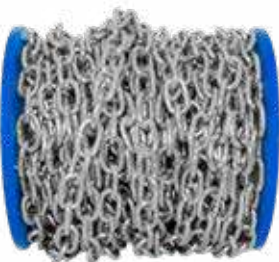

D Ø	T mm	B mm	Mtl Mtl	Carga trabajo Load capacity	Cód. producto Product code	Cód. EAN EAN code	Acero inox. Stainless steel
3 mm	16 mm	12 mm	30 m	40 kg	832901051190	8434035129108	ACERO INOX
4 mm	16 mm	13,6 mm	15 m	80 kg	832901071170	8434035120969	ACERO INOX
5 mm	18,5 mm	17 mm	30 m	125 kg	832901091190	8434035120976	ACERO INOX
6 mm	18,5 mm	20,4 mm	15 m	160 kg	832901101170	8434035120983	ACERO INOX

Todas las dimensiones y pesos indicados, especialmente las capacidades de carga, son valores teóricos. Antes de su uso, se debe de definir cual va a ser el propósito de estos artículos.
All dimensions and weights stated, especially load capacities, are theoretical values without obligation. The articles must be checked for their suitability for the purpose in mind before use.

Cadena de acero DIN 5685-2

Round-steel chains DIN 5685-2

Página 120 Tarifa. Page 120 Price List.

Cadena de acero cincada, según la norma DIN 5685-2, con eslabones semilargos que aportan una gran resistencia.
Round steel chain, zinc-plated, DIN 5685-2. It has semi long links that grant great resistance.



Cincada / Zinc-plated steel

► Ud. Cadena de acero cincada DIN 5685-2 - Precortada

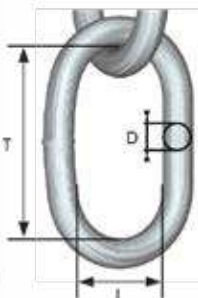

D Ø	T mm	l mm	Mtl Mtl	Carga trabajo Load capacity	Cód. producto Product code	Cód. EAN EAN code
2 mm	12 mm	3,5 mm	5 m	20 kg	830902022370	8434035118607
3 mm	16 mm	5,5 mm	5 m	40 kg	830902052370	8434035118614
4 mm	19 mm	7 mm	3 m	80 kg	830902072050	8434035118621
5 mm	21 mm	9 mm	2 m	125 kg	830902092040	8434035120556
6 mm	24 mm	11 mm	2 m	160 kg	830902102040	8434035120563



Cincada / Zinc-plated steel

► Ud. Carrete cadena de acero cincada DIN 5685-2 - Al corte



D Ø	T mm	l mm	Mtl Mtl	Carga trabajo Load capacity	Cód. producto Product code	Cód. EAN EAN code
2 mm	12 mm	3,5 mm	60 m	20 kg	830902021670	8434035120846
3 mm	16 mm	5,5 mm	30 m	40 kg	830902051190	8434035120853
4 mm	19 mm	7 mm	30 m	80 kg	830902071190	8434035120860
5 mm	21 mm	9 mm	30 m	125 kg	830402091190	8434035118904
6 mm	24 mm	11 mm	15 m	160 kg	830402101170	8434035118911



Galvanizado a fuego / Hot dip galvanised

► Ud. Carrete cadena de acero galvanizado al fuego DIN 5685-2 - Al corte



D Ø	T mm	l mm	Mtl Mtl	Carga trabajo Load capacity	Cód. producto Product code	Cód. EAN EAN code
4 mm	19 mm	7 mm	30 m	80 kg	830903071190	8434035120891
6 mm	24 mm	11 mm	15 m	160 kg	830903101170	8434035120907

Todas las dimensiones y pesos indicados, especialmente las capacidades de carga, son valores teóricos. Antes de su uso, se debe de definir cual va a ser el propósito de estos artículos.
All dimensions and weights stated, especially load capacities, are theoretical values without obligation. The articles must be checked for their suitability for the purpose in mind before use.

Cadena de polietileno

PE - Plastic chains

Página 120 Tarifa. Page 120 Price List.

Cadena de polietileno resistente a los rayos UV, ideal para delimitar, marcar y asegurar. Versátil y fácil de montar.
PE - Plastic Chain, UV resistant, minimal weight, for use in crowd control systems. It is versatile and easy to install.



Polietileno Negro / Black PE-Plastic



Polietileno Negro-Amarillo / Black-Yellow PE-Plastic



Polietileno Rojo-Blanco / Red-White PE-Plastic



Polietileno Cobre / Copper PE-Plastic

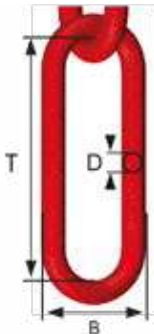

► Ud. Cadena de polietileno - Precortada

D Ø	T mm	B mm	Mtl Mtl	Cód. producto Product code	Cód. EAN EAN code	Tipo Type
6 mm	41 mm	19 mm	5 m	830408102376	8434035120655	PET
6 mm	41 mm	19 mm	5 m	830408102378	8434035120662	PET
6 mm	41 mm	19 mm	5 m	830408102379	8434035120679	PET
10 mm	70 mm	32 mm	4 m	830408142075	8434035120686	PET
10 mm	70 mm	32 mm	4 m	830408142076	8434035120693	PET

► Ud. Carrete cadena de polietileno - Al corte

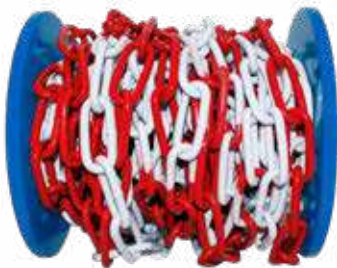

D Ø	T mm	B mm	Mtl Mtl	Cód. producto Product code	Cód. EAN EAN code	Tipo Type
6 mm	41 mm	19 mm	25 m	830408101229	8434035120709	PET
6 mm	41 mm	19 mm	25 m	830408101226	8434035120716	PET
6 mm	41 mm	19 mm	25 m	830408101228	8434035120723	PET
6 mm	41 mm	19 mm	25 m	830408101224	8434035120730	PET
8 mm	62 mm	27 mm	12,5 m	830408121439	8434035120747	PET
8 mm	62 mm	27 mm	12,5 m	830408121436	8434035120754	PET
10 mm	70 mm	32 mm	6 m	830408141086	8434035120761	PET
10 mm	70 mm	32 mm	6 m	830408141085	8434035120778	PET

Todas las dimensiones y pesos indicados, especialmente las capacidades de carga, son valores teóricos. Antes de su uso, se debe definir cual va a ser el propósito de estos artículos.
All dimensions and weights stated, especially load capacities, are theoretical values without obligation. The articles must be checked for their suitability for the purpose in mind before use.

Cadena redondeada

Small twisted chains

Página 121 Tarifa. Page 121 Price List.

Cadena redondeada con eslabones de acero niquelada de gran duración y versatilidad.
Round steel chain, nickel-plated. Long-lasting and great versatility.



Niquelada / Nickel-plated



Niquelada / Nickel-plated

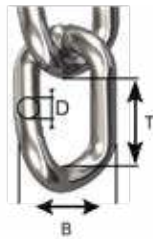

► Ud. Cadena redondeada - Precortada

D Ø	T mm	B mm	Mtl Mtl	Cód. producto Product code	Cód. EAN EAN code	Tipo Type
2 mm	9 mm	7,5 mm	1 m	832605022870	8434035120495	Niquelada
2,5 mm	11 mm	9,5 mm	1 m	832605042870	8434035120501	Niquelada
2,5 mm	11 mm	9,5 mm	1 m	832611042876	8434035120518	Negra

Cadena de nudos DIN 5686

Knotted chains DIN 5686

Página 121 Tarifa. Page 121 Price List.

Cadena de nudos conforme a la norma DIN 5686, versátil y duradera.
Knotted-link chain DIN 5686. Long-lasting and great versatility.



Cincada / Zinc-plated steel

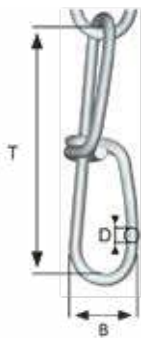

► Ud. Cadena de nudos DIN 5686 - Precortada

D Ø	T mm	B mm	Mtl Mtl	Cód. producto Product code	Cód. EAN EAN code	Tipo Type
1 mm	14 mm	4,5 mm	5 m	831002002370	8434035120525	Cincada
1,6 mm	22 mm	7 mm	5 m	831002542370	8434035118676	Cincada
1,8 mm	25 mm	8 mm	5 m	831002332370	8434035120549	Cincada
2,2 mm	31 mm	10 mm	5 m	831002562370	8434035118683	Cincada
2,5 mm	35 mm	11 mm	5 m	831002042370	8434035118690	Cincada
2,8 mm	39 mm	13 mm	5 m	831002572370	8434035118706	Cincada



► Ud. Cadena de nudos de acero inoxidable - Precortada

D Ø	T mm	B mm	Mtl Mtl	Cód. producto Product code	Cód. EAN EAN code	Acero inox. Stainless steel
1,6 mm	22 mm	7 mm	5 m	833501542370	8434035120532	ACERO INOX

Todas las dimensiones y pesos indicados, especialmente las capacidades de carga, son valores teóricos. Antes de su uso, se debe de definir cual va a ser el propósito de estos artículos.
All dimensions and weights stated, especially load capacities, are theoretical values without obligation. The articles must be checked for their suitability for the purpose in mind before use.

Cadena barbada

Curb chains

Página 121 Tarifa. Page 121 Price List.

Cadena barbada decorativa, versátil y duradera.
Decorative and long-lasting curb chain with great versatility.



Niquelada / Nickel-plated



Latónada / Brass-plated

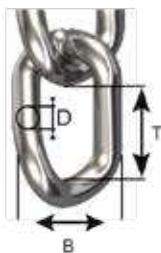

► Ud. Cadena barbada - Precortada

D Ø	T mm	B mm	Mtl Mtl	Cód. producto Product code	Cód. EAN EAN code	Tipo Type
1,2 mm	4,5 mm	3,9 mm	1 m	830505592870	8434035118720	Niquelada
1,8 mm	6,4 mm	6,3 mm	2,5 m	830504332895	8434035118744	Latónada

Cadena malla

Chandelier chains

Página 121 Tarifa. Page 121 Price List.

Cadena malla de latón niquelado, decorativa y versátil.
Nickel-plated chandelier chain suitable for humid areas, great versatility.



Niquelada / Nickel-plated

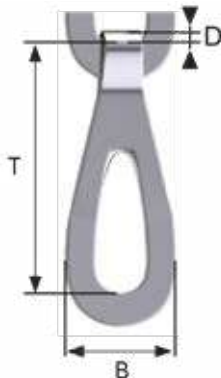

► Ud. Cadena malla latón - Precortada

D Ø	T mm	B mm	Mtl Mtl	Cód. producto Product code	Cód. EAN EAN code	Tipo Type
0,4 mm	14 mm	5 mm	1 m	831105582870	8434035118713	Niquelada

Todas las dimensiones y pesos indicados, especialmente las capacidades de carga, son valores teóricos. Antes de su uso, se debe de definir cual va a ser el propósito de estos artículos.
All dimensions and weights stated, especially load capacities, are theoretical values without obligation. The articles must be checked for their suitability for the purpose in mind before use.

Cadena decoración

Decorative chains

Cadena de decoración con eslabones largos de acero, latonado o niquelado de gran versatilidad.
Decorative steel chain, brass-plated or nickel-plated, with long links that grant great versatility.



Latonada / Brass-plated



Niquelada / Nickel-plated



Acero / Steel

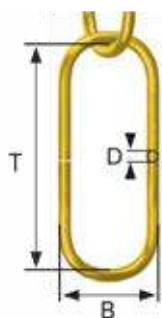

► Ud. Cadena decoración - Precortada

D Ø	T mm	B mm	Mtl Mtl	Cód. producto Product code	Cód. EAN EAN code	Tipo Type
2,5 mm	29 mm	15 mm	2,5 m	830704042895	8434035118751	Latonada
2,5 mm	29 mm	15 mm	2,5 m	830705042894	8434035120624	Niquelada
2,8 mm	35 mm	15,6 mm	2,5 m	830702572896	8434035118775	Acero



Acero / Steel



Niquelada / Nickel-plated

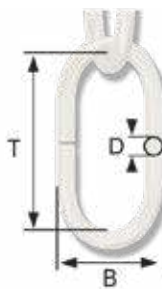

► Ud. Cadena decoración - Precortada

D Ø	T mm	B mm	Mtl Mtl	Cód. producto Product code	Cód. EAN EAN code	Tipo Type
2 mm	16 mm	10,4 mm	1 m	830702022876	8434035118768	Acero
2 mm	16 mm	10,4 mm	1 m	830705022874	8434035118782	Niquelada



Acero / Steel



Latonada / Brass-plated

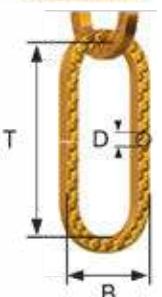

► Ud. Cadena decoración - Precortada

D Ø	T mm	B mm	Mtl Mtl	Cód. producto Product code	Cód. EAN EAN code	Tipo Type
2 mm	17 mm	9 mm	2,5 m	830711022896	8434035120631	Acero
3 mm	29 mm	14,5 mm	2,5 m	830711052896	8434035120648	Acero
4 mm	29 mm	16,5 mm	2,5 m	830704072895	8434035118737	Latonada

Todas las dimensiones y pesos indicados, especialmente las capacidades de carga, son valores teóricos. Antes de su uso, se debe de definir cual va a ser el propósito de estos artículos.
All dimensions and weights stated, especially load capacities, are theoretical values without obligation. The articles must be checked for their suitability for the purpose in mind before use.

Cadena de reloj

Clock chains

Cadena de reloj decorativa de acero niquelado o de estaño. Muy versátil.
Decorative clock chains nickel-plated and tin-plated. Very versatile.



Estaño / Tin-plated



Niquelada / Nickel-plated

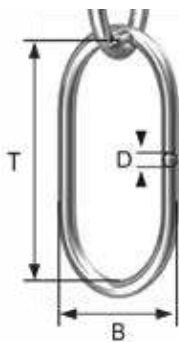

► Ud. Cadena de reloj - Precortada

D Ø	T mm	B mm	Mtl Mtl	Cód. producto Product code	Cód. EAN EAN code	Tipo Type
1 mm	6 mm	4,5 mm	3,5 m	832709002065	8434035120617	Estaño
1,2 mm	7 mm	5 mm	3,5 m	832705592060	8434035120600	Niquelada



Todas las dimensiones y pesos indicados, especialmente las capacidades de carga, son valores teóricos. Antes de su uso, se debe de definir cual va a ser el propósito de estos artículos.
All dimensions and weights stated, especially load capacities, are theoretical values without obligation. The articles must be checked for their suitability for the purpose in mind before use.



Accesorios

Accessories

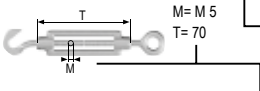
► Polibag Polybag

Diámetro Diameter	ROMBULL Ø M 5 mm	Art.-Nr.: 812502093030	Código de artículo Article code
Acabado Finish	Tensor gancho cincado	 8 434035 118584	Código EAN EAN code
Unidades Quantity	1 x		Carga de trabajo Load capacity
Traducción Translation	(F) Tendeur galvanisé (NL) Wartel, spanslot galvanisch	Se informa sobre los datos de capacidad de carga sin compromiso. Rogamos se compruebe la carga antes de aplicar el producto.	Dimensiones Measures
		Rombull Ronets, s.l. Camino de los Clérigos, S/N -A ptdo. 9 03360 CALLOSA DEL SEGURA (ALICANTE) Telf. +34 966 758 130 Fax +34 965 312 528 info@rombull.es	Información complementaria Additional information
		(GB) Turnbuckle zinc-plated (I) Tenditore a vite zincata (S) Spännlås förzinkad (CZ) Napínák pozink www.rombull.es	Información del vendedor Seller information

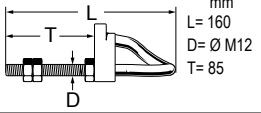
► Producto unitario sin envase Unit product without packaging

Código de artículo Article code	Art.-Nr.: 811402993030	ROMBULL 160 mm	Diámetro Diameter
Código EAN EAN code	 8 434035 118584	Gancho columpio cincado	Unidades Quantity
Dimensiones Measures		1 x	Acabado Finish
Carga de trabajo Load capacity			Traducción Translation
	(GB) Swing hook zinc-plated (I) Gancio di sicurezza a dondolo zincata (S) Säkerhetskarbinhake förzinkad (CZ) Háč bezpečnostní pro houpačku pozink www.rombull.es	(F) Crochet de sécurité galvanisé (NL) Veiligheidskruhaak galvanisch	Información del vendedor Seller information

► Promobox Promobox

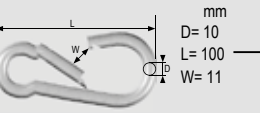
Diámetro Diameter	ROMBULL Ø 10 mm	Ref: 811502145170	Código de artículo Article code
Acabado Finish	Gancho de mosquetón cincado	 8 434035 118843	Carga de trabajo Load capacity
Unidades Quantity	15 x		Código EAN EAN code
Traducción Translation	(GB) Snap hook zinc-plated (DE) Karabinerhaken, verzinkt (F) Mousqueton galvanisé (I) Moschettone zincata (PT) Mosquetão Zincado	Rombull Ronets, s.l. Camino de los Clérigos S/N -A ptdo. 9, 03360 CALLOSA DEL SEGURA (ALICANTE) Telf. +34 966 758 130, Fax +34 965 312 528 info@rombull.es www.rombull.es	Dimensiones Measures
			Información del vendedor Seller information

Mosquetón bombero con seguro

Carabiner snap hook with screw



Página 123 Tarifa. Page 123 Price List.



D mm	L mm	W mm	Kg Kg	Tipo Type
6	60	6	120	ACERO INOX
8	80	8	200	ACERO INOX
10	100	11	300	ACERO INOX
6	60	5	120	CINCADO
8	80	9	200	CINCADO

Mosquetón bombero con seguro de acero inoxidable o cincado de alta resistencia. Ideal para unir cadenas de manera rápida, fácil y segura. Incluye un cierre de seguridad con rosca para evitar aperturas involuntarias.

Snap hook with a screw in stainless steel or zinc-plated steel. Ideal to link chains in a fast, easy and safe way. It includes a safety screw lock to avoid unwanted openings.

► Polibag - Mosquetón bombero con seguro



D Ø	Uds. por polibag Uts. per polybag	Cód. producto Product code	Cód. EAN EAN code	Ud. acondicionado Minimum order quantity	Carga trabajo Load capacity	Tipo Type
6 mm	1	811601104030	8434035123113	5	120 Kg	ACERO INOX
6 mm	2	811601104040	8434035126633	5	120 Kg	ACERO INOX
8 mm	1	811601124030	8434035129061	5	200 Kg	ACERO INOX
8 mm	2	811601124040	8434035126657	5	200 Kg	ACERO INOX
10 mm	1	811601144030	8434035123120	5	300 Kg	ACERO INOX
10 mm	2	811601144040	8434035128545	5	300 Kg	ACERO INOX
6 mm	2	811602104040	8434035126695	5	120 Kg	CINCADO
6 mm	4	811602104070	8434035126688	5	120 Kg	CINCADO
8 mm	1	811602124030	8434035118270	5	200 Kg	CINCADO
8 mm	2	811602124040	8434035126718	5	200 Kg	CINCADO

► Promobox - Mosquetón bombero con seguro



D Ø	Uds. por promobox Uts. per promobox	Cód. producto Product code	Cód. EAN EAN code	Carga trabajo Load capacity	Tipo Type
6 mm	25	811601105220	8434035126626	120 Kg	ACERO INOX
8 mm	10	811601125160	8434035126640	200 Kg	ACERO INOX
6 mm	25	811602105220	8434035126671	120 Kg	CINCADO
8 mm	10	811602125160	8434035119444	200 Kg	CINCADO

► Caja - Mosquetón bombero con seguro



D Ø	Uds. por caja Uts. per box	Cód. producto Product code	Cód. EAN EAN code	Carga trabajo Load capacity	Tipo Type
6 mm	50	811601107110	8434035121621	120 Kg	ACERO INOX
8 mm	20	811601127180	8434035121645	200 Kg	ACERO INOX
10 mm	10	811601147160	8434035121638	300 Kg	ACERO INOX
6 mm	50	811602107110	8434035126664	120 Kg	CINCADO
6 mm	100	811602107090	8434035121652	120 Kg	CINCADO
8 mm	25	811602127220	8434035126701	200 Kg	CINCADO
8 mm	50	811602127110	8434035121669	200 Kg	CINCADO

Todas las dimensiones y pesos indicados, especialmente las capacidades de carga, son valores teóricos. Antes de su uso, se debe de definir cual va a ser el propósito de estos artículos.
All dimensions and weights stated, especially load capacities, are theoretical values without obligation. The articles must be checked for their suitability for the purpose in mind before use.

Mosquetón bombero inoxidable

Stainless steel carabiner snap hook



Página 124 Tarifa. Page 124 Price List.

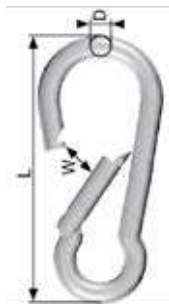

D mm	L mm	W mm	Kg Kg	Acero inox. Stain. steel
4	40	5	10	ACERO INOX
5	50	6	50	ACERO INOX
6	60	8	120	ACERO INOX
8	80	9	200	ACERO INOX
10	100	11	300	ACERO INOX

Mosquetón bombero de acero inoxidable de alta resistencia. Ideal para unir cadenas de manera rápida, fácil y segura.
Stainless steel snap hooks. Ideal to link chains in a fast, easy and safe way.



► Polibag - Mosquetón bombero inoxidable

D Ø	Uds. por polibag Uts. per polybag	Cód. producto Product code	Cód. EAN EAN code	Ud. acondicionado Minimum order quantity	Carga trabajo Load capacity	Acero inox. Stainless steel
4 mm	2	811501074040	8434035126473	5	10 Kg	ACERO INOX
5 mm	2	811501094040	8434035118447	5	50 Kg	ACERO INOX
6 mm	1	811501104030	8434035126503	5	120 Kg	ACERO INOX
8 mm	1	811501124030	8434035118461	5	200 Kg	ACERO INOX
10 mm	1	811501144030	8434035118478	5	300 Kg	ACERO INOX



► Promobox - Mosquetón bombero inoxidable

D Ø	Uds. por promobox Uts. per promobox	Cód. producto Product code	Cód. EAN EAN code	Carga trabajo Load capacity	Acero inox. Stainless steel
4 mm	50	811501075110	8434035126466	10 Kg	ACERO INOX
5 mm	25	811501095220	8434035126480	50 Kg	ACERO INOX
6 mm	25	811501105220	8434035126497	120 Kg	ACERO INOX
8 mm	10	811501125160	8434035126510	200 Kg	ACERO INOX



► Caja - Mosquetón bombero inoxidable

D Ø	Uds. por caja Uts. per box	Cód. producto Product code	Cód. EAN EAN code	Carga trabajo Load capacity	Acero inox. Stainless steel
5 mm	50	811501097110	8434035121546	50 Kg	ACERO INOX
6 mm	50	811501107110	8434035121553	120 Kg	ACERO INOX
8 mm	20	811501127180	8434035121560	200 Kg	ACERO INOX
10 mm	10	811501147160	8434035121577	300 Kg	ACERO INOX

Todas las dimensiones y pesos indicados, especialmente las capacidades de carga, son valores teóricos. Antes de su uso, se debe de definir cual va a ser el propósito de estos artículos.
All dimensions and weights stated, especially load capacities, are theoretical values without obligation. The articles must be checked for their suitability for the purpose in mind before use.

Mosquetón bombero cincado

Zinc-plated carabiner snap hook

Página 124 Tarifa. Page 124 Price List.

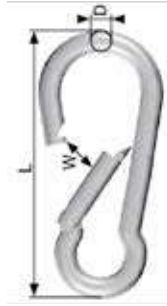

D mm	L mm	W mm	Kg Kg
5	50	7	50
6	60	8	120
8	80	10	200
10	100	11	300

Mosquetón bombero de acero cincado de alta resistencia. Ideal para unir cadenas de manera rápida, fácil y segura.
Zinc-plated steel snap hooks. Ideal to link chains in a fast, easy and safe way.

► Polibag - Mosquetón bombero cincado



D Ø	Uds. por polibag Uts. per polybag	Cód. producto Product code	Cód. EAN EAN code	Ud. acondicionado Minimum order quantity	Carga trabajo Load capacity
5 mm	2	811502094040	8434035118249	5	50 Kg
5 mm	4	811502094070	8434035126527	5	50 Kg
5 mm	6	811502094080	8434035126534	5	50 Kg
6 mm	2	811502124040	8434035126565	5	120 Kg
6 mm	4	811502104070	8434035126558	5	120 Kg
8 mm	1	811502124030	8434035118256	5	200 Kg
8 mm	2	811502124040	8434035126589	5	200 Kg
10 mm	1	811502144030	8434035118263	5	300 Kg
10 mm	2	811502144040	8434035126619	5	300 Kg

► Promobox - Mosquetón bombero cincado



D Ø	Uds. por promobox Uts. per promobox	Cód. producto Product code	Cód. EAN EAN code	Carga trabajo Load capacity
5 mm	25	811502095220	8434035119406	50 Kg
6 mm	25	811502105220	8434035126541	120 Kg
8 mm	10	811502125160	8434035119413	200 Kg

► Caja - Mosquetón bombero cincado



D Ø	Uds. por caja Uts. per box	Cód. producto Product code	Cód. EAN EAN code	Carga trabajo Load capacity
5 mm	100	811502097090	8434035121584	50 Kg
6 mm	100	811502107090	8434035121591	120 Kg
8 mm	25	811502127220	8434035126572	200 Kg
8 mm	50	811502127110	8434035121607	200 Kg
10 mm	10	811502147160	8434035126602	300 Kg
10 mm	50	811502147110	8434035126596	300 Kg

Todas las dimensiones y pesos indicados, especialmente las capacidades de carga, son valores teóricos. Antes de su uso, se debe de definir cual va a ser el propósito de estos artículos.
All dimensions and weights stated, especially load capacities, are theoretical values without obligation. The articles must be checked for their suitability for the purpose in mind before use.

Mosquetón con seguro inoxidable

Stainless steel quick link with screw



Página 125 Tarifa. Page 125 Price List.

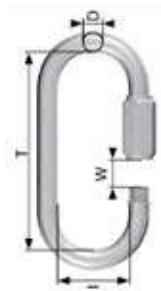

D mm	T mm	I mm	W mm	Kg Kg	Acero inox. Stain. steel
4	32	12	5,4	90	ACERO INOX
6	46	16	7	200	ACERO INOX
8	58	20	10	300	ACERO INOX

Mosquetón con seguro de acero inoxidable, de enlace rápido para la unión de cadenas. Gran capacidad de carga y resistencia. Stainless Steel quick link with screw, used to link in a quick and practical way chains. It has a great load capacity and resistance.

► Polibag - Mosquetón con seguro inoxidable



D Ø	Uds. por polibag Uts. per polybag	Cód. producto Product code	Cód. EAN EAN code	Ud. acondicionado Minimum order quantity	Carga trabajo Load capacity	Acero inox. Stainless steel
4 mm	1	812001074030	8434035126138	5	90 Kg	ACERO INOX
4 mm	2	812001074040	8434035122901	5	90 Kg	ACERO INOX
4 mm	4	812001074070	8434035126145	5	90 Kg	ACERO INOX
4 mm	6	812001074080	8434035126121	5	90 Kg	ACERO INOX
4 mm	8	812001074340	8434035126152	5	90 Kg	ACERO INOX
6 mm	1	812001104030	8434035122918	5	200 Kg	ACERO INOX
6 mm	2	812001104040	8434035126169	5	200 Kg	ACERO INOX
6 mm	4	812001104070	8434035126176	5	200 Kg	ACERO INOX
8 mm	1	812001124030	8434035118423	5	300 Kg	ACERO INOX
8 mm	2	812001124040	8434035126183	5	300 Kg	ACERO INOX

► Caja - Mosquetón con seguro inoxidable



D Ø	Uds. por caja Uts. per box	Cód. producto Product code	Cód. EAN EAN code	Carga trabajo Load capacity	Acero inox. Stainless steel
4 mm	20	812001077180	8434035121317	90 Kg	ACERO INOX
6 mm	20	812001107180	8434035121324	200 Kg	ACERO INOX
8 mm	10	812001127160	8434035121331	300 Kg	ACERO INOX

Todas las dimensiones y pesos indicados, especialmente las capacidades de carga, son valores teóricos. Antes de su uso, se debe de definir cual va a ser el propósito de estos artículos. All dimensions and weights stated, especially load capacities, are theoretical values without obligation. The articles must be checked for their suitability for the purpose in mind before use.

Mosquetón con seguro cincado

Zinc-plated quick link with screw

Página 125 Tarifa. Page 125 Price List.



D mm	T mm	I mm	W mm	Kg Kg
4	33	11	5,4	90
5	40	14	6	150
6	46	15	7	200
8	58	18	10	300

Mosquetón con seguro de acero cincado, de enlace rápido para la unión de cadenas. Gran capacidad de carga y resistencia.
Quick link with screw made of zinc-plated steel, used to link in a quick and practical way chains. It has a great load capacity and resistance.

► Polibag - Mosquetón con seguro cincado



D Ø	Uds. por polibag Uts. per polybag	Cód. producto Product code	Cód. EAN EAN code	Ud. acondicionado Minimum order quantity	Carga trabajo Load capacity
4 mm	2	812002074040	8434035122932	5	90 Kg
4 mm	4	812002074070	8434035126190	5	90 Kg
4 mm	8	812002074340	8434035126206	5	90 Kg
5 mm	2	812002094040	8434035122949	5	150 Kg
5 mm	4	812002094070	8434035126213	5	150 Kg
5 mm	8	812002094340	8434035126220	5	150 Kg
6 mm	2	812002104040	8434035118201	5	200 Kg
6 mm	4	812002104070	8434035126237	5	200 Kg
8 mm	1	812002124030	8434035118218	5	300 Kg
8 mm	2	812002124040	8434035126251	5	300 Kg

► Promobox - Mosquetón con seguro cincado



D Ø	Uds. por promobox Uts. per promobox	Cód. producto Product code	Cód. EAN EAN code	Carga trabajo Load capacity
4 mm	20	812002075180	8434035122925	90 Kg
5 mm	20	812002095180	8434035121355	150 Kg
6 mm	20	812002105180	8434035122956	200 Kg
8 mm	10	812002125160	8434035122963	300 Kg

► Caja - Mosquetón con seguro cincado



D Ø	Uds. por caja Uts. per box	Cód. producto Product code	Cód. EAN EAN code	Carga trabajo Load capacity
4 mm	40	812002077510	8434035121348	90 Kg
5 mm	40	812002097510	8434035123991	150 Kg
6 mm	40	812002107510	8434035121362	200 Kg
8 mm	20	812002127180	8434035121379	300 Kg

Todas las dimensiones y pesos indicados, especialmente las capacidades de carga, son valores teóricos. Antes de su uso, se debe de definir cual va a ser el propósito de estos artículos.
All dimensions and weights stated, especially load capacities, are theoretical values without obligation. The articles must be checked for their suitability for the purpose in mind before use.

Grillete con perno inoxidable

Stainless steel shackle



Página 126 Tarifa. Page 126 Price List.

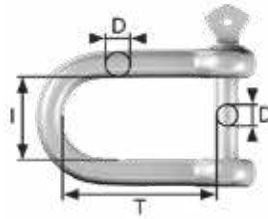

D mm	T mm	I mm	Kg Kg	Acero inox. Stain. steel
5	20	10	80	ACERO INOX
6	25	12	100	ACERO INOX
8	32	19	150	ACERO INOX
10	38	20	250	ACERO INOX

Grillete con perno de acero inoxidable, ideal para unir, fijar cadenas de manera fácil y rápida. Duradero, resistente y con una alta carga de trabajo.

Stainless steel shackle with bolt, ideal to link and fix chains in an easy and fast way. Long-lasting, resistant and high load capacity.

► Polibag - Grillete con perno inoxidable



D Ø	Uds. por polibag Uts. per polybag	Cód. producto Product code	Cód. EAN EAN code	Ud. acondicionado Minimum order quantity	Carga trabajo Load capacity	Acero inox. Stainless steel
5 mm	2	811801094040	8434035126879	5	80 Kg	ACERO INOX
5 mm	4	811801094070	8434035126862	5	80 Kg	ACERO INOX
6 mm	2	811801104040	8434035118430	5	100 Kg	ACERO INOX
6 mm	4	811801104070	8434035126893	5	100 Kg	ACERO INOX
8 mm	2	811801124040	8434035126909	5	150 Kg	ACERO INOX
10 mm	1	811801144030	8434035126886	5	250 Kg	ACERO INOX

► Promobox - Grillete con perno inoxidable



D Ø	Uds. por promobox Uts. per promobox	Cód. producto Product code	Cód. EAN EAN code	Carga trabajo Load capacity	Acero inox. Stainless steel
5 mm	10	811801095160	8434035121782	80 Kg	ACERO INOX
6 mm	10	811801105160	8434035121805	100 Kg	ACERO INOX
8 mm	5	811801125370	8434035121812	150 Kg	ACERO INOX
10 mm	5	811801145370	8434035121799	250 Kg	ACERO INOX

Todas las dimensiones y pesos indicados, especialmente las capacidades de carga, son valores teóricos. Antes de su uso, se debe de definir cual va a ser el propósito de estos artículos.
All dimensions and weights stated, especially load capacities, are theoretical values without obligation. The articles must be checked for their suitability for the purpose in mind before use.

Grillete con perno cincado

Zinc-plated shackle

Página 126 Tarifa. Page 126 Price List.

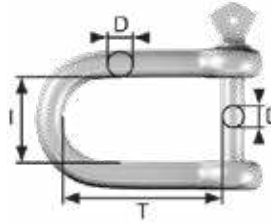

D mm	T mm	I mm	Kg Kg
5	20	10	80
6	25	12	100
8	32	16	150
10	40	18	250

Grillete con perno de acero cincado, ideal para unir, fijar cadenas de manera fácil y rápida. Duradero, resistente y con una alta carga de trabajo.

Shackle with bolt zinc-plated, ideal to link and fix chains in an easy and fast way. Long-lasting, resistant and high load capacity.

► Polibag - Grillete con perno cincado



D Ø	Uds. por polibag Uts. per polybag	Cód. producto Product code	Cód. EAN EAN code	Ud. acondicionado Minimum order quantity	Carga trabajo Load capacity
5 mm	2	811802094040	8434035123229	5	80 Kg
5 mm	4	811802094070	8434035126978	5	80 Kg
5 mm	6	811802094080	8434035126985	5	80 Kg
6 mm	1	811802104030	8434035126947	5	100 Kg
6 mm	2	811802104040	8434035118225	5	100 Kg
6 mm	4	811802104070	8434035126930	5	100 Kg
8 mm	1	811802124030	8434035127043	5	150 Kg
8 mm	2	811802124040	8434035118232	5	150 Kg
10 mm	1	811802144030	8434035127005	5	250 Kg
10 mm	2	811802144040	8434035127012	5	250 Kg

► Promobox - Grillete con perno cincado



D Ø	Uds. por promobox Uts. per promobox	Cód. producto Product code	Cód. EAN EAN code	Carga trabajo Load capacity
5 mm	25	811802095220	8434035126961	80 Kg
6 mm	25	811802105220	8434035126923	100 Kg
8 mm	10	811802125160	8434035123243	150 Kg

► Caja - Grillete con perno cincado



D Ø	Uds. por caja Uts. per box	Cód. producto Product code	Cód. EAN EAN code	Carga trabajo Load capacity
5 mm	50	811802097110	8434035126954	80 Kg
5 mm	100	811802097090	8434035121836	80 Kg
6 mm	50	811802107110	8434035126916	100 Kg
6 mm	100	811802107090	8434035121829	100 Kg
8 mm	25	811802127220	8434035127029	150 Kg
8 mm	50	811802127110	8434035121850	150 Kg
10 mm	10	811802147160	8434035126992	250 Kg
10 mm	25	811802147220	8434035121843	250 Kg

Todas las dimensiones y pesos indicados, especialmente las capacidades de carga, son valores teóricos. Antes de su uso, se debe de definir cual va a ser el propósito de estos artículos.
All dimensions and weights stated, especially load capacities, are theoretical values without obligation. The articles must be checked for their suitability for the purpose in mind before use.

Guardacabo

Thimble



Página 127 Tarifa. Page 127 Price List.

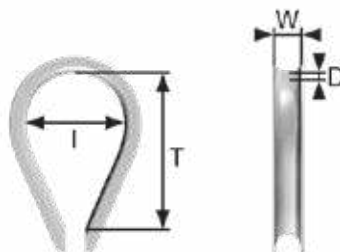

W mm	I mm	T mm	D mm	Tipo Tipe
3	12	19	1,6	ACERO INOX
6	16	25	2,4	ACERO INOX
8	20	32	2,8	ACERO INOX
3	12	19	1,6	CINCADO
5	14	23	1,9	CINCADO
8	20	32	2,8	CINCADO

Guardacabo de acero inoxidable o cincado de alta durabilidad. Evita la torsión, desgaste de cables y cuerdas.
Long-lasting stainless steel or zinc-plated thimbles. It avoids the torsion and attrition of ropes.

► Polibag - Guardacabo



W mm	Uds. por polibag Uts. per polybag	Cód. producto Product code	Cód. EAN EAN code	Ud. acondicionado Minimum order quantity	Tipo Tipe
3 mm	2	811901054040	8434035123489	5	ACERO INOX
3 mm	4	811901054070	8434035127746	5	ACERO INOX
6 mm	2	811901104040	8434035123496	5	ACERO INOX
6 mm	4	811901104070	8434035127777	5	ACERO INOX
8 mm	2	811901124040	8434035123502	5	ACERO INOX
8 mm	4	811901124070	8434035127807	5	ACERO INOX
3 mm	2	811902054040	8434035118379	5	CINCADO
3 mm	4	811902054070	8434035127838	5	CINCADO
3 mm	8	811902054340	8434035127821	5	CINCADO
5 mm	2	811902094040	8434035123533	5	CINCADO
5 mm	4	811902094070	8434035127869	5	CINCADO
5 mm	6	811902094080	8434035127852	5	CINCADO
8 mm	2	811902124040	8434035118386	5	CINCADO
8 mm	4	811902124070	8434035127890	5	CINCADO

► Caja - Guardacabo



W mm	Uds. por caja Uts. per box	Cód. producto Product code	Cód. EAN EAN code	Tipo Tipe
3 mm	100	811901057090	8434035122147	ACERO INOX
6 mm	50	811901107110	8434035127760	ACERO INOX
6 mm	100	811901107090	8434035127753	ACERO INOX
8 mm	25	811901127220	8434035127791	ACERO INOX
8 mm	50	811901127110	8434035127784	ACERO INOX
8 mm	100	811901127090	8434035122161	ACERO INOX
3 mm	50	811902057110	8434035127814	CINCADO
3 mm	100	811902057090	8434035122178	CINCADO
5 mm	25	811902097220	8434035127845	CINCADO
5 mm	100	811902097090	8434035122185	CINCADO
8 mm	10	811902127160	8434035127883	CINCADO
8 mm	25	811902127220	8434035127876	CINCADO
8 mm	100	811902127090	8434035122192	CINCADO

Todas las dimensiones y pesos indicados, especialmente las capacidades de carga, son valores teóricos. Antes de su uso, se debe de definir cual va a ser el propósito de estos artículos.
All dimensions and weights stated, especially load capacities, are theoretical values without obligation. The articles must be checked for their suitability for the purpose in mind before use.

Tensor gancho con argolla

Turnbuckle with hook and eye

Página 127 Tarifa. Page 127 Price List.

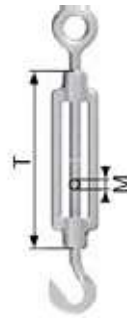

M mm	T mm	Tipo Tipe
M 5	90	ACERO INOX
M 6	90	ACERO INOX
M 8	120	ACERO INOX
M 5	70	CINCADO
M 6	110	CINCADO
M 8	110	CINCADO
M 10	125	CINCADO
M 12	125	CINCADO

Tensor gancho con argolla de acero inoxidable o cincado, incorpora un gancho y una argolla con rosca métrica. Ideal para la unión y tensión de cadenas y cuerdas.

Stainless steel or zinc-plated steel turnbuckle which ends with a hook and an eye. It is ideal for adjusting the length and tension of chains and ropes.

► Ud. Tensor gancho con argolla



M mm	Unidades Units	Cód. producto Product code	Cód. EAN EAN code	Ud. acondicionado Minimum order quantity	Tipo Tipe
M 5	1	812501093030	8434035118515	5	ACERO INOX
M 6	1	812501103030	8434035118522	5	ACERO INOX
M 8	1	812501123030	8434035126817	5	ACERO INOX
M 5	1	812502093030	8434035118539	5	CINCADO
M 6	1	812502103030	8434035118546	5	CINCADO
M 8	1	812502123030	8434035118553	5	CINCADO
M 10	1	812502143030	8434035118560	5	CINCADO
M 12	1	812502163030	8434035118577	5	CINCADO

► Caja - Tensor gancho con argolla



M mm	Uds. por caja Uts. per box	Cód. producto Product code	Cód. EAN EAN code	Tipo Tipe
M 5	50	812501097110	8434035126794	ACERO INOX
M 5	100	812501097090	8434035121713	ACERO INOX
M 6	50	812501107110	8434035126800	ACERO INOX
M 6	100	812501107090	8434035121720	ACERO INOX
M 8	100	812501127090	8434035121768	ACERO INOX
M 5	50	812502097110	8434035126824	CINCADO
M 5	100	812502097090	8434035121744	CINCADO
M 6	50	812502107110	8434035128781	CINCADO
M 6	100	812502107090	8434035121751	CINCADO
M 8	25	812502127220	8434035126831	CINCADO
M 8	100	812502127090	8434035121737	CINCADO
M 10	20	812502147180	8434035126848	CINCADO
M 10	100	812502147090	8434035121775	CINCADO
M 12	20	812502167180	8434035126855	CINCADO
M 12	50	812502167110	8434035122864	CINCADO

Todas las dimensiones y pesos indicados, especialmente las capacidades de carga, son valores teóricos. Antes de su uso, se debe de definir cual va a ser el propósito de estos artículos.
All dimensions and weights stated, especially load capacities, are theoretical values without obligation. The articles must be checked for their suitability for the purpose in mind before use.

Sujetacable inoxidable

Stainless steel wire rope clip



Página 128 Tarifa. Page 128 Price List.



D mm	W mm	Acero inox. Stain. steel
4	3	ACERO INOX
5	6	ACERO INOX
6	8	ACERO INOX
8	11	ACERO INOX

Sujetacable de acero inoxidable, ideal para la fijación y sujeción de cables de acero. Duradero y fácil de usar.
Stainless steel wire rope clip, ideal to fix steel cables. Long-lasting and easy to use.



► Polibag - Sujetacable inoxidable

W mm	Uds. por polibag Uts. per polybag	Cód. producto Product code	Cód. EAN EAN code	Ud. acondicionado Minimum order quantity	Acero inox. Stainless steel
3 mm	4	812401054070	8434035127241	5	ACERO INOX
6 mm	2	812401104040	8434035118508	5	ACERO INOX
8 mm	2	812401124040	8434035127289	5	ACERO INOX
11 mm	2	812401154040	8434035127319	5	ACERO INOX

► Caja - Sujetacable inoxidable



W mm	Uds. por caja Uts. per box	Cód. producto Product code	Cód. EAN EAN code	Acero inox. Stainless steel
3 mm	50	812401057110	8434035127234	ACERO INOX
3 mm	100	812401057090	8434035121928	ACERO INOX
6 mm	50	812401107110	8434035127258	ACERO INOX
6 mm	100	812401107090	8434035121935	ACERO INOX
8 mm	20	812401127180	8434035127272	ACERO INOX
8 mm	50	812401127110	8434035127265	ACERO INOX
8 mm	100	812401127090	8434035121942	ACERO INOX
11 mm	10	812401157160	8434035127302	ACERO INOX
11 mm	25	812401157220	8434035127296	ACERO INOX
11 mm	100	812401157090	8434035121959	ACERO INOX

Todas las dimensiones y pesos indicados, especialmente las capacidades de carga, son valores teóricos. Antes de su uso, se debe de definir cual va a ser el propósito de estos artículos.
All dimensions and weights stated, especially load capacities, are theoretical values without obligation. The articles must be checked for their suitability for the purpose in mind before use.

Sujetacable cincado

Zinc-plated wire rope clip

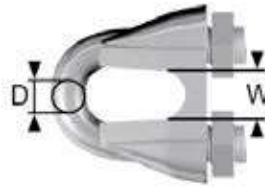

D mm	W mm
4	3
5	5
5	6,5
6	8
8	11

Sujetacable de acero cincado, ideal para la fijación y sujeción de cables de acero. Duradero y fácil de usar.
Zinc-plated steel wire rope clip, ideal to fix steel cables. Long-lasting and easy to use.

► Polibag - Sujetacable cincado



W mm	Uds. por polibag Uts. per polybag	Cód. producto Product code	Cód. EAN EAN code	Ud. acondicionado Minimum order quantity
3 mm	2	812402054040	8434035118317	5
3 mm	4	812402054070	8434035127326	5
3 mm	6	812402054080	8434035127333	5
3 mm	8	812402054340	8434035127340	5
5 mm	2	812402094040	8434035119352	5
5 mm	4	812402094070	8434035127395	5
5 mm	6	812402094080	8434035127401	5
6,5 mm	2	812402534040	8434035118324	5
6,5 mm	4	812402534070	8434035127357	5
6,5 mm	6	812402534080	8434035127364	5
8 mm	2	812402124040	8434035118331	5
8 mm	4	812402124070	8434035127388	5
11 mm	2	812402154040	8434035123311	5

► Promobox - Sujetacable cincado



W mm	Uds. por promobox Uts. per promobox	Cód. producto Product code	Cód. EAN EAN code
3 mm	50	812402055110	8434035118850
5 mm	50	812402095110	8434035119475
6,5 mm	25	812402535220	8434035119482

► Caja - Sujetacable cincado



W mm	Uds. por caja Uts. per box	Cód. producto Product code	Cód. EAN EAN code
3 mm	100	812402057090	8434035121966
5 mm	100	812402097090	8434035121997
8 mm	20	812402127180	8434035128798
8 mm	50	812402127110	8434035127371
8 mm	100	812402127090	8434035121980
11 mm	10	812402157160	8434035127425
11 mm	25	812402157220	8434035127418
11 mm	100	812402157090	8434035122000

Todas las dimensiones y pesos indicados, especialmente las capacidades de carga, son valores teóricos. Antes de su uso, se debe de definir cual va a ser el propósito de estos artículos.
All dimensions and weights stated, especially load capacities, are theoretical values without obligation. The articles must be checked for their suitability for the purpose in mind before use.

Sujetacable plano simple inoxidable

Stainless steel wire rope clip simplex



Página 129 Tarifa. Page 129 Price List.

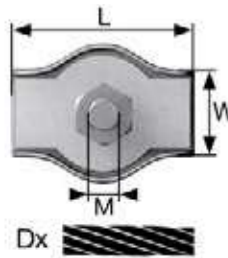

Dx Ø mm	M mm	L mm	W mm	Acero inox. Stain. steel
4	M 5	21	8	ACERO INOX
6	M 6	30	12	ACERO INOX

Sujetacable plano simple de acero inoxidable de rápido montaje. Facilita la sujeción y fijación de cables de acero y cuerdas.
Stainless steel wire rope clip simplex, easy to install. It helps to fix cables and ropes.



► Polibag - Sujetacable plano simple inoxidable

D Ø	Uds. por polibag Uts. per polybag	Cód. producto Product code	Cód. EAN EAN code	Ud. acondicionado Minimum order quantity	Acero inox. Stainless steel
4 mm	2	812301074040	8434035123366	5	ACERO INOX
4 mm	4	812301074070	8434035127579	5	ACERO INOX
6 mm	2	812301104040	8434035123373	5	ACERO INOX
6 mm	4	812301104070	8434035127593	5	ACERO INOX



► Promobox - Sujetacable plano simple inoxidable

D Ø	Uds. por promobox Uts. per promobox	Cód. producto Product code	Cód. EAN EAN code	Acero inox. Stainless steel
4 mm	25	812301075220	8434035127562	ACERO INOX
6 mm	25	812301105220	8434035127586	ACERO INOX



► Caja - Sujetacable plano simple inoxidable

D Ø	Uds. por caja Uts. per box	Cód. producto Product code	Cód. EAN EAN code	Acero inox. Stainless steel
4 mm	100	812301077090	8434035122062	ACERO INOX
6 mm	100	812301107090	8434035122079	ACERO INOX

Todas las dimensiones y pesos indicados, especialmente las capacidades de carga, son valores teóricos. Antes de su uso, se debe de definir cual va a ser el propósito de estos artículos.
All dimensions and weights stated, especially load capacities, are theoretical values without obligation. The articles must be checked for their suitability for the purpose in mind before use.

Sujetacable plano simple cincado

Zinc-plated wire rope clip simplex

Página 129 Tarifa. Page 129 Price List.

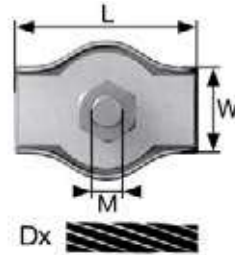

Dx Ø mm	M mm	L mm	W mm
2	M 3,5	17	4
3	M 4	19	6
4	M 5	21	8
6	M 6	30	12
8	M 8	38	23

Sujetacable plano simple de acero cincado de rápido montaje. Facilita la sujeción y fijación de cables de acero y cuerdas.
Zinc-plated wire rope clip simplex, easy to install. It helps to fix cables and ropes.

► Polibag - Sujetacable plano simple cincado



D Ø	Uds. por polibag Uts. per polybag	Cód. producto Product code	Cód. EAN EAN code	Ud. acondicionado Minimum order quantity
2 mm	2	812302024040	8434035123328	5
2 mm	4	812302024070	8434035127456	5
2 mm	8	812302024340	8434035127449	5
3 mm	2	812302054040	8434035118355	5
3 mm	4	812302054070	8434035127487	5
3 mm	8	812302054340	8434035127470	5
4 mm	2	812302074040	8434035123717	5
4 mm	4	812302074070	8434035127517	5
4 mm	8	812302074340	8434035127500	5
6 mm	2	812302104040	8434035123342	5
6 mm	4	812302104070	8434035127531	5
8 mm	2	812302124040	8434035123359	5

► Promobox - Sujetacable plano simple cincado



D Ø	Uds. por promobox Uts. per promobox	Cód. producto Product code	Cód. EAN EAN code
2 mm	50	812302025110	8434035127432
3 mm	50	812302055110	8434035127463
4 mm	25	812302075220	8434035127494
6 mm	25	812302105220	8434035127524
8 mm	10	812302125160	8434035127555

► Caja - Sujetacable plano simple cincado



D Ø	Uds. por caja Uts. per box	Cód. producto Product code	Cód. EAN EAN code
2 mm	100	812302027090	8434035122017
3 mm	100	812302057090	8434035122024
4 mm	100	812302077090	8434035122031
6 mm	100	812302107090	8434035122048
8 mm	20	812302127180	8434035127548
8 mm	100	812302127090	8434035122055

Todas las dimensiones y pesos indicados, especialmente las capacidades de carga, son valores teóricos. Antes de su uso, se debe de definir cual va a ser el propósito de estos artículos.
All dimensions and weights stated, especially load capacities, are theoretical values without obligation. The articles must be checked for their suitability for the purpose in mind before use.

Sujetacable plano doble inoxidable

Stainless steel wire rope clip duplex



Página 130 Tarifa. Page 130 Price List.

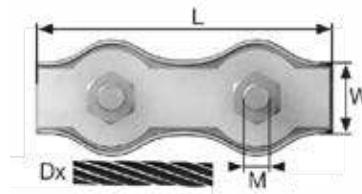

Dx Ø mm	M mm	L mm	W mm	Acero inox. Stain. steel
4	M 5	43	8	ACERO INOX
6	M 6	60	12	ACERO INOX

Sujetacable plano doble de acero inoxidable de rápido montaje. Facilita la sujeción y fijación de cables de acero y cuerdas.
Stainless steel wire rope clip duplex, easy to install. It helps to fix cables and ropes.



► Polibag - Sujetacable plano doble inoxidable

D Ø	Uds. por polibag Uts. per polybag	Cód. producto Product code	Cód. EAN EAN code	Ud. acondicionado Minimum order quantity	Acero inox. Stainless steel
4 mm	2	811201074040	8434035123465	5	ACERO INOX
4 mm	4	811201074070	8434035127715	5	ACERO INOX
6 mm	2	811201104040	8434035123472	5	ACERO INOX



► Promobox - Sujetacable plano doble inoxidable

D Ø	Uds. por promobox Uts. per promobox	Cód. producto Product code	Cód. EAN EAN code	Acero inox. Stainless steel
4 mm	25	811201075220	8434035127708	ACERO INOX
6 mm	10	811201105160	8434035127739	ACERO INOX



► Caja - Sujetacable plano doble inoxidable

D Ø	Uds. por caja Uts. per box	Cód. producto Product code	Cód. EAN EAN code	Acero inox. Stainless steel
4 mm	100	811201077090	8434035122123	ACERO INOX
6 mm	20	811201107180	8434035127722	ACERO INOX
6 mm	100	811201107090	8434035122130	ACERO INOX

Todas las dimensiones y pesos indicados, especialmente las capacidades de carga, son valores teóricos. Antes de su uso, se debe de definir cual va a ser el propósito de estos artículos.
All dimensions and weights stated, especially load capacities, are theoretical values without obligation. The articles must be checked for their suitability for the purpose in mind before use.

Sujetacable plano doble cincado

Zinc-plated wire rope clip duplex

Página 130 Tarifa. Page 130 Price List.

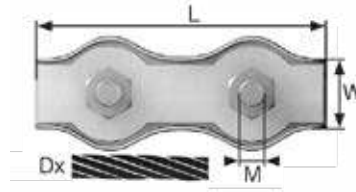

Dx Ø mm	M mm	L mm	W mm
2	M 3,5	36	4
3	M 4	39	6
4	M 5	43	8
6	M 6	60	12
8	M 8	75	24

Sujetacable plano doble de acero cincado de rápido montaje. Facilita la sujeción y fijación de cables de acero y cuerdas.
Zinc-plated wire rope clip duplex, easy to install. It helps to fix cables and ropes.

► Polibag - Sujetacable plano doble cincado



D Ø	Uds. por polibag Uts. per polybag	Cód. producto Product code	Cód. EAN EAN code	Ud. acondicionado Minimum order quantity
2 mm	2	811202024040	8434035123434	5
2 mm	4	811202024070	8434035127692	5
2 mm	8	811202024340	8434035127685	5
3 mm	2	811202054040	8434035118362	5
3 mm	4	811202054070	8434035127623	5
3 mm	8	811202054340	8434035127616	5
4 mm	2	811202074040	8434035123694	5
4 mm	4	811202074070	8434035127647	5
6 mm	2	811202104040	8434035123427	5
8 mm	2	811202124040	8434035123458	5

► Promobox - Sujetacable plano doble cincado



D Ø	Uds. por promobox Uts. per promobox	Cód. producto Product code	Cód. EAN EAN code
2 mm	50	811202025110	8434035127678
3 mm	25	811202055220	8434035127609
4 mm	25	811202075220	8434035127630
6 mm	10	811202105160	8434035127661

► Caja - Sujetacable plano doble cincado



D Ø	Uds. por caja Uts. per box	Cód. producto Product code	Cód. EAN EAN code
2 mm	100	811202027090	8434035122109
3 mm	100	811202057090	8434035122888
4 mm	100	811202077090	8434035122086
6 mm	20	811202107180	8434035127654
6 mm	100	811202107090	8434035122093
8 mm	15	811202127170	8434035123441
8 mm	100	811202127090	8434035122116

Todas las dimensiones y pesos indicados, especialmente las capacidades de carga, son valores teóricos. Antes de su uso, se debe de definir cual va a ser el propósito de estos artículos.
All dimensions and weights stated, especially load capacities, are theoretical values without obligation. The articles must be checked for their suitability for the purpose in mind before use.

Eslabón roto acero cincado

Repair links



D mm	T mm	I mm
4	20	7
5	23	9
6	28	10
8	37	14

Eslabón roto de acero cincado de gran estabilidad y fácil instalación. Ideal para la extensión y unión de cadenas.
Zinc-plated steel repair links. Great stability, easy to install. Ideal for the extension and union of chains.

► Polibag - Eslabón roto acero cincado



D Ø	Uds. por polibag Uts. per polybag	Cód. producto Product code	Cód. EAN EAN code	Ud. acondicionado Minimum order quantity
4 mm	2	813002074040	8434035125988	5
4 mm	4	813002074070	8434035125995	5
4 mm	6	813002074080	8434035126008	5
4 mm	10	813002074160	8434035126015	5
5 mm	2	813002094040	8434035126022	5
5 mm	4	813002094070	8434035126039	5
6 mm	2	813002104040	8434035126077	5
6 mm	4	813002104070	8434035126084	5
8 mm	1	813002124030	8434035126114	5

► Promobox - Eslabón roto acero cincado



D Ø	Uds. por promobox Uts. per promobox	Cód. producto Product code	Cód. EAN EAN code
5 mm	40	813002095510	8434035126046
6 mm	25	813002105220	8434035126060
8 mm	10	813002125160	8434035126107

► Caja - Eslabón roto acero cincado



D Ø	Uds. por caja Uts. per box	Cód. producto Product code	Cód. EAN EAN code
4 mm	100	813002077090	8434035121270
5 mm	100	813002097090	8434035121287
6 mm	50	813002107110	8434035126053
6 mm	100	813002107090	8434035121294
8 mm	25	813002127220	8434035126091
8 mm	50	813002127110	8434035121300

Todas las dimensiones y pesos indicados, especialmente las capacidades de carga, son valores teóricos. Antes de su uso, se debe de definir cual va a ser el propósito de estos artículos.
All dimensions and weights stated, especially load capacities, are theoretical values without obligation. The articles must be checked for their suitability for the purpose in mind before use.

Eslabón roto polietileno

PE-Plastic quick link

Página 131 Tarifa. Page 131 Price List.



Dx Ø mm	Color Color
------------	----------------

6	Rojo
---	------

Eslabón roto de polietileno de gran estabilidad y fácil instalación. Ideal para la extensión y unión de cadenas.

PE-Plastic quick link. Great stability, easy to install. Ideal for the extension and union of chains.



► Polibag - Eslabón roto polietileno

D Ø	Uds. por polibag Uts. per polybag	Cód. producto Product code	Cód. EAN EAN code	Ud. acondicionado Minimum order quantity	Color Color
6 mm	2	813008104043	8434035122970	5	Rojo
6 mm	4	813008104073	8434035126268	5	Rojo



► Caja - Eslabón roto polietileno

D Ø	Uds. por caja Uts. per box	Cód. producto Product code	Cód. EAN EAN code	Color Color
6 mm	20	813008107183	8434035121386	Rojo

Eslabón roto polietileno con gancho

PE-Plastic hooks / connector

Página 131 Tarifa. Page 131 Price List.



Dx Ø mm	Color Color
------------	----------------

6	Blanco
6	Rojo

Eslabón roto de polietileno con gancho de gran estabilidad y fácil instalación. Ideal para la extensión y unión de cadenas.

PE-Plastic connector with hook. Great stability, easy to install. Ideal for the extension and union of chains.



► Polibag - Eslabón roto polietileno con gancho

D Ø	Uds. por polibag Uts. per polybag	Cód. producto Product code	Cód. EAN EAN code	Ud. acondicionado Minimum order quantity	Color Color
6 mm	2	813608104044	8434035126275	5	Blanco
6 mm	2	813608104043	8434035126282	5	Rojo
6 mm	4	813608104074	8434035126299	5	Blanco
6 mm	4	813608104073	8434035126305	5	Rojo



► Caja - Eslabón roto polietileno con gancho

D Ø	Uds. por caja Uts. per box	Cód. producto Product code	Cód. EAN EAN code	Color Color
6 mm	10	813608107164	8434035121393	Blanco
6 mm	10	813608107163	8434035121409	Rojo

Todas las dimensiones y pesos indicados, especialmente las capacidades de carga, son valores teóricos. Antes de su uso, se debe de definir cual va a ser el propósito de estos artículos.
All dimensions and weights stated, especially load capacities, are theoretical values without obligation. The articles must be checked for their suitability for the purpose in mind before use.

Grillete giratorio

Swivels

ACERO INOXIDABLE
STAINLESS STEEL

Página 132 Tarifa. Page 132 Price List.

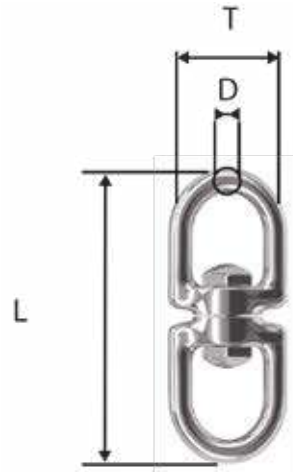

D mm	L mm	T mm	Tipo Tipe
6	66,5	15	ACERO INOX
8	88,4	20,2	ACERO INOX
4,5	59	12,2	NIQUELADO

Grillete giratorio de acero inoxidable o niquelado. Ideal para evitar una brusca torsión de la carga. Útil para cadenas o cuerdas con grandes diámetros.

Stainless steel or nickel-plated steel swivels. Indicated to avoid the rough torsion of the load. Useful with thick chains or ropes.



► Polibag - Grillete giratorio

D Ø	Uds. por polibag Uts. per polybag	Cód. producto Product code	Cód. EAN EAN code	Ud. acondicionado Minimum order quantity	Tipo Tipe
6 mm	1	811301104030	8434035118485	5	ACERO INOX
8 mm	1	811301124030	8434035123151	5	ACERO INOX
8 mm	2	811301124040	8434035126756	5	ACERO INOX
4,5 mm	1	811305084030	8434035123168	5	NIQUELADO
4,5 mm	2	811305084040	8434035126763	5	NIQUELADO
4,5 mm	4	811305084070	8434035126770	5	NIQUELADO
4,5 mm	6	811305084080	8434035126787	5	NIQUELADO



► Caja - Grillete giratorio

D Ø	Uds. por caja Uts. per box	Cód. producto Product code	Cód. EAN EAN code	Tipo Tipe
6 mm	10	811301107160	8434035121683	ACERO INOX
8 mm	10	811301127160	8434035121690	ACERO INOX
4,5 mm	10	811305087160	8434035121706	NIQUELADO



Todas las dimensiones y pesos indicados, especialmente las capacidades de carga, son valores teóricos. Antes de su uso, se debe de definir cual va a ser el propósito de estos artículos.
All dimensions and weights stated, especially load capacities, are theoretical values without obligation. The articles must be checked for their suitability for the purpose in mind before use.

Mosquetón aluminio anodizado

Snap hook aluminium anodized

Página 132 Tarifa. Page 132 Price List.



D mm	L mm	W mm	Tipo Tipe
6	60	10	Azul anodizado
6	60	10	Verde anodizado

Mosquetón de aluminio anodizado versátil y de uso fácil. Incorpora un resorte que facilita el enganche de cuerdas y objetos. Anodized aluminum snap hook. Versatile and easy to use. It has a spring that helps to hook it up.



► Polibag - Mosquetón aluminio anodizado

D Ø	Uds. por polibag Uts. per polybag	Cód. producto Product code	Cód. EAN EAN code	Ud. acondicionado Minimum order quantity	Tipo Tipe
6 mm	2	811512104042	8434035128415	5	Azul anodizado
6 mm	4	811512104072	8434035128422	5	Azul anodizado
6 mm	2	811512104041	8434035128446	5	Verde anodizado
6 mm	4	811512104071	8434035128491	5	Verde anodizado



► Caja - Mosquetón aluminio anodizado

D Ø	Uds. por caja Uts. per box	Cód. producto Product code	Cód. EAN EAN code	Tipo Tipe
6 mm	25	811512107222	8434035128408	Azul anodizado
6 mm	50	811512107112	8434035124875	Azul anodizado
6 mm	25	811512107221	8434035128439	Verde anodizado
6 mm	50	811512107111	8434035124851	Verde anodizado



Todas las dimensiones y pesos indicados, especialmente las capacidades de carga, son valores teóricos. Antes de su uso, se debe de definir cual va a ser el propósito de estos artículos. All dimensions and weights stated, especially load capacities, are theoretical values without obligation. The articles must be checked for their suitability for the purpose in mind before use.

Anilla elevación cincada macho

Ring screws

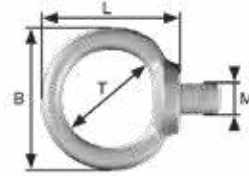

M mm	B mm	T mm	L mm	Kg Kg
M 6	36	20	36	50
M 8	36	20	36	90
M 10	45	25	45	150

Anilla elevación macho de acero cincado de alta resistencia. Ideal para la fijación y soporte de peso. Fácil y rápido montaje, soporta una gran carga de trabajo.

Zinc-plated ring screws with high resistance. Ideal to fix and support weight. Easy and fast to install, it manages a great work load.



► Polibag - Anilla elevación cincada macho

M mm	Uds. por polibag Uts. per polybag	Cód. producto Product code	Cód. EAN EAN code	Ud. acondicionado Minimum order quantity	Carga trabajo Load capacity
M 6	1	813702104030	8434035123267	5	50 Kg
M 6	2	813702104040	8434035127166	5	50 Kg
M 8	1	813702124030	8434035123274	5	90 Kg
M 8	2	813702124040	8434035127197	5	90 Kg
M 10	1	813702144030	8434035123281	5	150 Kg
M 10	2	813702144040	8434035127210	5	150 Kg



► Promobox - Anilla elevación cincada macho

M mm	Uds. por promobox Uts. per promobox	Cód. producto Product code	Cód. EAN EAN code	Carga trabajo Load capacity
M 6	10	813702105160	8434035127159	50 Kg
M 8	10	813702125160	8434035127180	90 Kg
M 10	6	813702145080	8434035127227	150 Kg



► Caja - Anilla elevación cincada macho

M mm	Uds. por caja Uts. per box	Cód. producto Product code	Cód. EAN EAN code	Carga trabajo Load capacity
M 6	25	813702107220	8434035127142	50 Kg
M 6	100	813702107090	8434035121898	50 Kg
M 8	25	813702127220	8434035127173	90 Kg
M 8	100	813702127090	8434035121904	90 Kg
M 10	15	813702147170	8434035127203	150 Kg
M 10	100	813702147090	8434035121911	150 Kg

Todas las dimensiones y pesos indicados, especialmente las capacidades de carga, son valores teóricos. Antes de su uso, se debe de definir cual va a ser el propósito de estos artículos.
All dimensions and weights stated, especially load capacities, are theoretical values without obligation. The articles must be checked for their suitability for the purpose in mind before use.

Anilla elevación cincada hembra

Ring nuts

Página 133 Tarifa. Page 133 Price List.

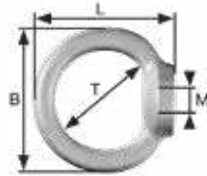

M mm	B mm	T mm	L mm	Kg Kg
M 6	36	20	36	50
M 8	36	20	36	90
M 10	45	25	45	150

Anilla elevación hembra de acero cincado de alta resistencia. Ideal para la fijación y soporte de peso. Fácil y rápido montaje, soporta una gran carga de trabajo.

High resistance zinc-plated steel ring nuts. Ideal to fix and support weight. Easy and fast to install, it manages a great work load.



► Polibag - Anilla elevación cincada hembra

M mm	Uds. por polibag Uts. per polybag	Cód. producto Product code	Cód. EAN EAN code	Ud. acondicionado Minimum order quantity	Carga trabajo Load capacity
M 6	1	810102104030	8434035123250	5	50 Kg
M 6	2	810102104040	8434035127074	5	50 Kg
M 8	1	810102124030	8434035118294	5	90 Kg
M 8	2	810102124040	8434035127104	5	90 Kg
M 10	1	810102144030	8434035118287	5	150 Kg
M 10	2	810102144040	8434035127128	5	150 Kg



► Promobox - Anilla elevación cincada hembra

M mm	Uds. por promobox Uts. per promobox	Cód. producto Product code	Cód. EAN EAN code	Carga trabajo Load capacity
M 6	10	810102105160	8434035127067	50 Kg
M 8	10	810102125160	8434035127098	90 Kg
M 10	6	810102145080	8434035128804	150 Kg



► Caja - Anilla elevación cincada hembra

M mm	Uds. por caja Uts. per box	Cód. producto Product code	Cód. EAN EAN code	Carga trabajo Load capacity
M 6	25	810102107220	8434035127050	50 Kg
M 6	100	810102107090	8434035121867	50 Kg
M 8	25	810102127220	8434035127081	90 Kg
M 8	100	810102127090	8434035121874	90 Kg
M 10	15	810102147170	8434035127111	150 Kg
M 10	100	810102147090	8434035121881	150 Kg

Todas las dimensiones y pesos indicados, especialmente las capacidades de carga, son valores teóricos. Antes de su uso, se debe de definir cual va a ser el propósito de estos artículos.
All dimensions and weights stated, especially load capacities, are theoretical values without obligation. The articles must be checked for their suitability for the purpose in mind before use.

Gancho con rosca

Screw hook

Página 134 Tarifa. Page 134 Price List.

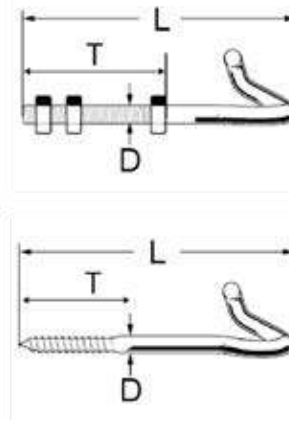

D mm	T mm	L mm
M 10	75	140
10	50	140

Gancho con rosca de acero cincado con gran capacidad de carga para una sujeción segura.
Screw hook of zinc-plated steel with a great load capacity to securely hang items.



► Ud. Gancho con rosca

D Ø	Unidades Units	Cód. producto Product code	Cód. EAN EAN code	Ud. acondicionado Minimum order quantity
M 10	1	813102143030	8434035126411	5
10	1	813202143030	8434035126428	5



► Caja - Gancho con rosca

D Ø	Uds. por caja Uts. per box	Cód. producto Product code	Cód. EAN EAN code
M 10	10	813102147160	8434035121478
10	10	813202147160	8434035121485

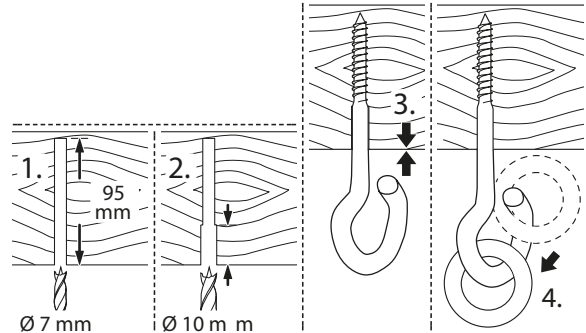
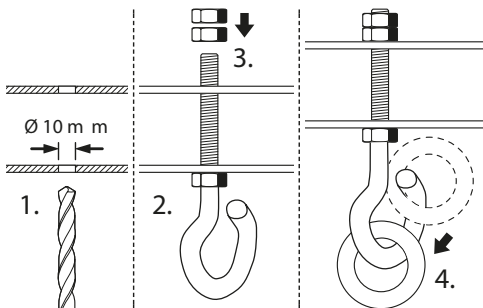

Todas las dimensiones y pesos indicados, especialmente las capacidades de carga, son valores teóricos. Antes de su uso, se debe de definir cual va a ser el propósito de estos artículos.
All dimensions and weights stated, especially load capacities, are theoretical values without obligation. The articles must be checked for their suitability for the purpose in mind before use.

Gancho columpio

Swing hook

Página 134 Tarifa. Page 134 Price List.



M 12

12

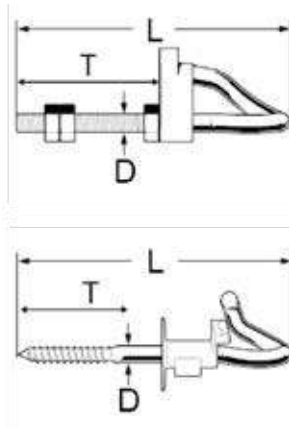

D mm	T mm	L mm	Kg Kg
M 12	85	160	100
12	65	180	100

Gancho columpio de acero cincado equipado con una pieza de seguridad para una gran capacidad de carga y sujeción. Swing hook of zinc-plated steel equipped with a security piece. It has a great load capacity to securely hang items.



► Ud. Gancho columpio

D Ø	Unidades Units	Cód. producto Product code	Cód. EAN EAN code	Ud. acondicionado Minimum order quantity	Carga trabajo Load capacity
M 12	1	811402993030	8434035118584	5	100 Kg
12	1	811402983030	8434035118591	5	100 Kg



► Caja - Gancho columpio

D Ø	Uds. por caja Uts. per box	Cód. producto Product code	Cód. EAN EAN code	Carga trabajo Load capacity
M 12	10	811402997160	8434035128811	100 Kg
12	10	811402987160	8434035126404	100 Kg
M 12	100	811402997090	8434035121454	100 Kg
12	100	811402987090	8434035121461	100 Kg

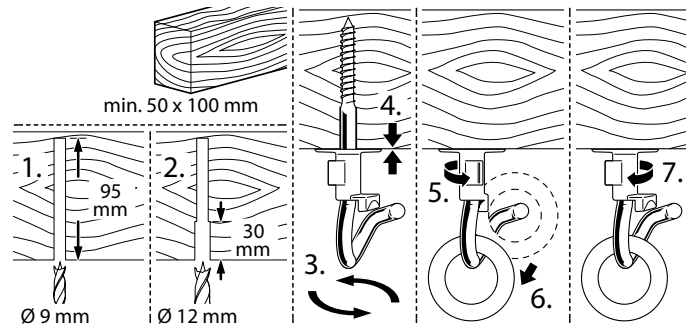
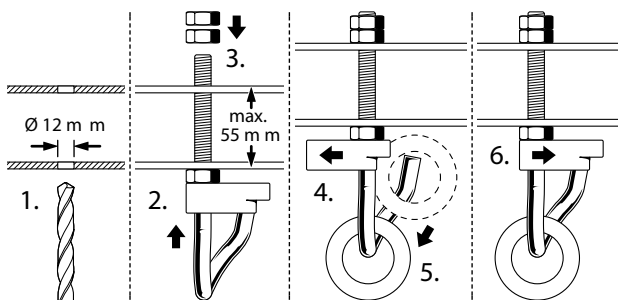

Todas las dimensiones y pesos indicados, especialmente las capacidades de carga, son valores teóricos. Antes de su uso, se debe de definir cual va a ser el propósito de estos artículos. All dimensions and weights stated, especially load capacities, are theoretical values without obligation. The articles must be checked for their suitability for the purpose in mind before use.

Gancho de amarre

Snap hook forged with spring catch



L mm
90

Gancho de amarre forjado. Alta resistencia, duración y de uso fácil. Ideal para enganchar de manera rápida cuerdas, cables y cadenas.
 Snap hook forged with spring catch. High resistance, long-lasting and easy to use. Ideal to hook in a simple and fast way ropes, chains and steel cables.



► Polibag - Gancho de amarre

L mm	Uds. por polibag Uts. per polybag	Cód. producto Product code	Cód. EAN EAN code	Ud. acondicionado Minimum order quantity
90 mm	1	814202904030	8434035128521	5



► Caja - Gancho de amarre

L mm	Uds. por caja Uts. per box	Cód. producto Product code	Cód. EAN EAN code
90 mm	4	814202907070	8434035128514
90 mm	10	814202907160	8434035122277



Todas las dimensiones y pesos indicados, especialmente las capacidades de carga, son valores teóricos. Antes de su uso, se debe de definir cual va a ser el propósito de estos artículos.
 All dimensions and weights stated, especially load capacities, are theoretical values without obligation. The articles must be checked for their suitability for the purpose in mind before use.

Gancho tipo S

S-Hook

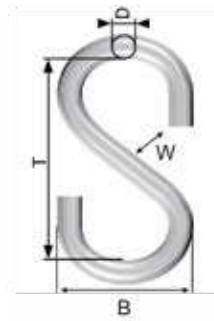

D mm	T mm	B mm	W mm
3	24	15	4,5
4	32	20	6
5	40	25	8
6	56	35	10

Gancho tipo S de acero cincado con gran versatilidad, resistencia a las temperaturas y a la abrasión. Especial para el uso con cadenas, cuerdas y correas.

S-hook of zinc-plated steel with a great versatility and resistance to high temperatures and abrasion. Specially made for applications with ropes, chains and steel cables.

► Polibag - Gancho tipo S



D Ø	Uds. por polibag Uts. per polybag	Cód. producto Product code	Cód. EAN EAN code	Ud. acondicionado Minimum order quantity
3 mm	2	811702054040	8434035123014	5
3 mm	5	811702054370	8434035126343	5
3 mm	10	811702054090	8434035126329	5
3 mm	20	811702054180	8434035126336	5
4 mm	2	811702074040	8434035118416	5
4 mm	4	811702074070	8434035126350	5
4 mm	10	811702074160	8434035126367	5
5 mm	2	811702094040	8434035118300	5
5 mm	4	811702094070	8434035126374	5
5 mm	8	811702094340	8434035126381	5
6 mm	2	811702104040	8434035123038	5

► Promobox - Gancho tipo S



D Ø	Uds. por promobox Uts. per promobox	Cód. producto Product code	Cód. EAN EAN code
3 mm	50	811702055110	8434035126312
4 mm	50	811702075110	8434035119383
5 mm	25	811702095220	8434035119390
6 mm	25	811702105220	8434035126398

► Caja - Gancho tipo S



D Ø	Uds. por caja Uts. per box	Cód. producto Product code	Cód. EAN EAN code
3 mm	100	811702057090	8434035121416
4 mm	100	811702077090	8434035121423
5 mm	100	811702097090	8434035121430
6 mm	100	811702107090	8434035121447

Todas las dimensiones y pesos indicados, especialmente las capacidades de carga, son valores teóricos. Antes de su uso, se debe de definir cual va a ser el propósito de estos artículos.
All dimensions and weights stated, especially load capacities, are theoretical values without obligation. The articles must be checked for their suitability for the purpose in mind before use.

Anillo

Ring



Página 136 Tarifa. Page 136 Price List.

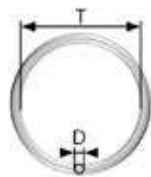

D mm	T mm	Tipo Tipe
6	40	ACERO INOX
8	45	ACERO INOX
6	35	CINCADO
8	45	CINCADO

Anillo de acero inoxidable o cincado de gran resistencia. Ideal para la extensión y posterior sujeción de cadenas y cuerdas.
Ring of stainless steel or zinc-plated steel of great resistance. Ideal for extending and fixing chains and ropes.

► Polibag - Anillo



D Ø	Uds. por polibag Uts. per polybag	Cód. producto Product code	Cód. EAN EAN code	Ud. acondicionado Minimum order quantity	Tipo Tipe
6 mm	4	813301104070	8434035126435	5	ACERO INOX
8 mm	2	813301124040	8434035126442	5	ACERO INOX
6 mm	4	813302104070	8434035126459	5	CINCADO
8 mm	2	813302124040	8434035123090	5	CINCADO

► Caja - Anillo



D Ø	Uds. por caja Uts. per box	Cód. producto Product code	Cód. EAN EAN code	Tipo Tipe
8 mm	20	813301127160	8434035121508	ACERO INOX
8 mm	20	813302127160	8434035121522	CINCADO



Todas las dimensiones y pesos indicados, especialmente las capacidades de carga, son valores teóricos. Antes de su uso, se debe de definir cual va a ser el propósito de estos artículos.
All dimensions and weights stated, especially load capacities, are theoretical values without obligation. The articles must be checked for their suitability for the purpose in mind before use.

Gancho de mosquetón

Snap hook

Página 136 Tarifa. Page 136 Price List.



L mm	W mm	I mm
52	6	11
78	8	12

Gancho de mosquetón de acero cincado con cierre de gatillo y anillo giratorio. Versátil y fácil de utilizar. Especial para la unión de cadenas y cuerdas.

Snap hook of zinc-plated steel with swivel. Versatile and easy to use. Specially recommended to link chains and ropes.

► Polibag - Gancho de mosquetón



L mm	Uds. por polibag Uts. per polybag	Cód. producto Product code	Cód. EAN EAN code	Ud. acondicionado Minimum order quantity
52 mm	1	813410104030	8434035123144	5
52 mm	2	813410104040	8434035126732	5
78 mm	1	813410124030	8434035127982	5
78 mm	2	813410124040	8434035127975	5

► Caja - Gancho de mosquetón



L mm	Uds. por caja Uts. per box	Cód. producto Product code	Cód. EAN EAN code
52 mm	25	813410107220	8434035126725
52 mm	100	813410107090	8434035121676
78 mm	20	813410127180	8434035127968
78 mm	50	813410127110	8434035127951
78 mm	100	813410127090	8434035124967

Llavero con cadena

Curb chain sets

Página 136 Tarifa. Page 136 Price List.



L cm
45

Llavero con cadenas barbadadas niqueladas de gran duración y versatilidad.

Key-ring with curb chain of nickel-plated steel. Long-lasting and versatile.

► Polibag - Llavero con cadena



L cm	Uds. por polibag Uts. per polybag	Cód. producto Product code	Cód. EAN EAN code	Ud. acondicionado Minimum order quantity
45 mm	1	814810104030	8434035127920	5

► Caja - Llavero con cadena



L cm	Uds. por caja Uts. per box	Cód. producto Product code	Cód. EAN EAN code
45 mm	10	814810107160	8434035125575

Todas las dimensiones y pesos indicados, especialmente las capacidades de carga, son valores teóricos. Antes de su uso, se debe de definir cual va a ser el propósito de estos artículos. All dimensions and weights stated, especially load capacities, are theoretical values without obligation. The articles must be checked for their suitability for the purpose in mind before use.

Polea de desviación

Pulley made of polyamide

Página 137 Tarifa. Page 137 Price List.

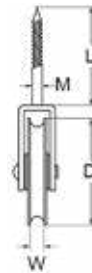

D mm	W mm	M mm	L mm	Kg kg
25	6	3,5	23	10
50	6	5,5	40	20

Polea de desviación en poliamida de alta duración y resistencia. Ideal para guiar, tensar cables y cuerdas.
Pulley of polyamide with screw. Long-lasting and high resistance. Ideal to guide and tense ropes and steel cables.



► Polibag - Polea de desviación

D mm	Uds. por polibag Uts. per polybag	Cód. producto Product code	Cód. EAN EAN code	Ud. acondicionado Minimum order quantity	Carga trabajo Load capacity
25 mm	1	812107464036	8434035118393	5	10 Kg
50 mm	1	812107504036	8434035123571	5	20 Kg

Polea de elevación

Hoist pulleys standard duty

Página 137 Tarifa. Page 137 Price List.

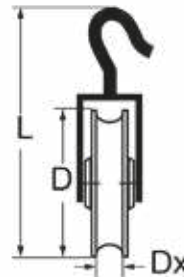

D mm	Dx Ø mm	L mm
80	8	160

Polea de elevación con gancho en acero cincado y rueda en poliamida. Incorpora un sistema para impedir la salida de cuerdas o cables. Ideal para la elevación de cargas.

Hoist pulley with a zinc-plated steel hook and a polyamide wheel. It has a system to avoid the exit of the steel cables and ropes. Ideal to raise loads.



► Ud. Polea de elevación

D mm	Unidades Units	Cód. producto Product code	Cód. EAN EAN code	Ud. acondicionado Minimum order quantity
80 mm	1	814003803030	8434035127944	5

Todas las dimensiones y pesos indicados, especialmente las capacidades de carga, son valores teóricos. Antes de su uso, se debe de definir cual va a ser el propósito de estos artículos.
All dimensions and weights stated, especially load capacities, are theoretical values without obligation. The articles must be checked for their suitability for the purpose in mind before use.

Roldana simple

Rope pulley single wheel

Página 137 Tarifa. Page 137 Price List.

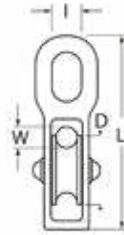

D mm	W mm	I mm	L mm
15	5	10	50
30	8	13	80
50	12	16	113

Roldana simple con carcasa de cinc galvanizado en caliente y rueda en poliamida, gran capacidad de carga. Especial para cables y cuerdas. Larga duración debido a sus ejes remachados.

Rope pulley with a die-cast zinc case and a single polyamide wheel. It has a great load capacity. Recommended for steel cables and ropes. Long-lasting riveted axle.



► Polibag - Roldana simple

D mm	Unidades Units	Cód. producto Product code	Cód. EAN EAN code	Ud. acondicionado Minimum order quantity
15 mm	1	812203244030	8434035123588	5
30 mm	1	812203294030	8434035118409	5
50 mm	1	812203623030	8434035127937	5

Roldana doble

Rope pulley twin wheel

Página 137 Tarifa. Page 137 Price List.

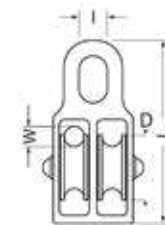

D mm	W mm	I mm	L mm
20	6	11	60
30	8	13	80
50	12	16	113

Roldana doble con carcasa de cinc galvanizado en caliente y rueda en poliamida, gran capacidad de carga. Especial para cables y cuerdas. Larga duración debido a sus ejes remachados.

Rope pulley with a die-cast zinc case and a double polyamide wheel. It has a great load capacity. Recommended for steel cables and ropes. Long-lasting riveted axle.



► Polibag - Roldana doble

D mm	Unidades Units	Cód. producto Product code	Cód. EAN EAN code	Ud. acondicionado Minimum order quantity
20 mm	1	814903204030	8434035125599	5
30 mm	1	814903294030	8434035125605	5
50 mm	1	814903623030	8434035125612	5

Todas las dimensiones y pesos indicados, especialmente las capacidades de carga, son valores teóricos. Antes de su uso, se debe de definir cual va a ser el propósito de estos artículos.
All dimensions and weights stated, especially load capacities, are theoretical values without obligation. The articles must be checked for their suitability for the purpose in mind before use.

Tornillo de ojo

Eyelet bolts

Página 138 Tarifa. Page 138 Price List.



Tornillo de ojo de acero cincado de gran resistencia. Ideal para superficies como hormigón, ladrillo y para el enganche de cuerdas o cadenas. Fácil instalación.

Eye bolt made of zinc-plated steel with great resistance. Ideal to attach ropes and chains to surfaces of concrete and bricks. Easy to install.

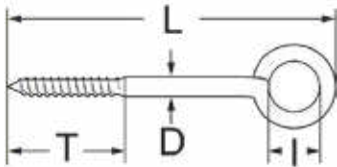

D mm	L mm	T mm	I mm
7,8	115	45	22



► Polibag - Tornillo de ojo

D Ø	Uds. por polibag Uts. per polybag	Cód. producto Product code	Cód. EAN EAN code	Ud. acondicionado Minimum order quantity
7,8 mm	1	814502124030	8434035128361	5
7,8 mm	2	814502124040	8434035123663	5



► Caja - Tornillo de ojo

D Ø	Uds. por caja Uts. per box	Cód. producto Product code	Cód. EAN EAN code
7,8 mm	10	814502127160	8434035122307

Tornillo de ojo con argolla

Eye bolts

Página 138 Tarifa. Page 138 Price List.

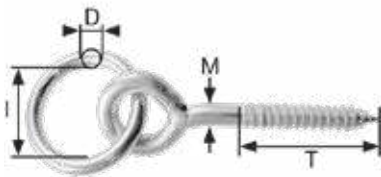

Tornillo de ojo con argolla de acero cincado de gran resistencia. Ideal para superficies como hormigón, ladrillo y el enganche de cuerdas o cadenas. Fácil instalación.

Eye bolt with a ring made of zinc-plated steel with great resistance. Ideal to attach ropes and chains to surfaces of concrete and bricks. Easy to install.

D mm	I mm	T mm	M mm
9	45	60	10



► Polibag - Tornillo de ojo con argolla

D Ø	Uds. por polibag Uts. per polybag	Cód. producto Product code	Cód. EAN EAN code	Ud. acondicionado Minimum order quantity
9 mm	1	814702134030	8434035128385	5



► Caja - Tornillo de ojo con argolla

D Ø	Uds. por caja Uts. per box	Cód. producto Product code	Cód. EAN EAN code
9 mm	10	814702137160	8434035124981

Todas las dimensiones y pesos indicados, especialmente las capacidades de carga, son valores teóricos. Antes de su uso, se debe de definir cual va a ser el propósito de estos artículos.
All dimensions and weights stated, especially load capacities, are theoretical values without obligation. The articles must be checked for their suitability for the purpose in mind before use.

Gancho hamaca

Hammock hook

Página 138 Tarifa. Page 138 Price List.

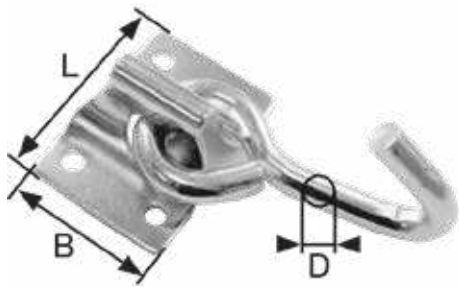

Gancho hamaca de acero cincado de alta resistencia. Gracias a su placa se puede montar en la pared de manera sencilla. Incorpora un gancho concediendo así una gran capacidad de carga.

Hammock hook of zinc-plated steel with great resistance. Thanks to its plate it can be attached to the wall in an easy way. It has a hook that grants a great capacity load.

D mm	L mm	B mm
9,5	65	45



► Ud. Gancho hamaca

D Ø	Unidades Units	Cód. producto Product code	Cód. EAN EAN code	Ud. acondicionado Minimum order quantity
9,5 mm	1	814302503030	8434035128316	5



► Caja - Gancho hamaca

D Ø	Uds. por caja Uts. per box	Cód. producto Product code	Cód. EAN EAN code
9,5 mm	10	814302507160	8434035122284

Placa con semianillo

Eye plate

Página 138 Tarifa. Page 138 Price List.

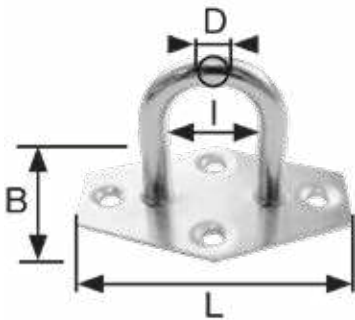

Placa con semianillo de acero cincado de gran durabilidad. presenta una placa hexagonal que facilita su montaje y un semianillo fijo que le aporta una gran carga de trabajo.

Eye plate of zinc-plated steel with great resistance. It has a hexagonal base that makes it easy to install. The fixed eye grants great load capacity to the article.

L mm	B mm	D mm	I mm
60	40	6	18



► Polibag - Placa con semianillo

D Ø	Uds. por polibag Uts. per polybag	Cód. producto Product code	Cód. EAN EAN code	Ud. acondicionado Minimum order quantity
6 mm	1	814402104030	8434035123656	5
6 mm	2	814402104040	8434035128330	5



► Caja - Placa con semianillo

D Ø	Uds. por caja Uts. per box	Cód. producto Product code	Cód. EAN EAN code
6 mm	20	814402107180	8434035128347
6 mm	100	814402107090	8434035122291

Todas las dimensiones y pesos indicados, especialmente las capacidades de carga, son valores teóricos. Antes de su uso, se debe de definir cual va a ser el propósito de estos artículos. All dimensions and weights stated, especially load capacities, are theoretical values without obligation. The articles must be checked for their suitability for the purpose in mind before use.

Gancho simple

Simplex hook

Página 139 Tarifa. Page 139 Price List.

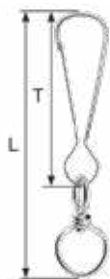

Gancho simple niquelado con dos eslabones oscilantes. Ideal para enganchar cuerdas y cadenas de manera fácil y rápida. La carga permanece segura.

Simplex hook with swivel made of nickel-plated steel. Ideal to attach chains and ropes in an easy and fast way. The load remains secured.

L mm	T mm
57	32
70	43
96	61



► Polibag - Gancho simple

L mm	Uds. por polibag Uts. per polybag	Cód. producto Product code	Cód. EAN EAN code	Ud. acondicionado Minimum order quantity
57 mm	2	814605344040	8434035128040	5
57 mm	4	814605344070	8434035128057	5
70 mm	2	814605434040	8434035128088	5
70 mm	4	814605434070	8434035128095	5
96 mm	2	814605614040	8434035128026	5



► Caja - Gancho simple

L mm	Uds. por caja Uts. per box	Cód. producto Product code	Cód. EAN EAN code
57 mm	100	814605347090	8434035124899
70 mm	50	814605437110	8434035128071
70 mm	100	814605437090	8434035124936
96 mm	25	814605617220	8434035128019
96 mm	100	814605617090	8434035124943

Ajustador de cuerda

Rope extender

Página 139 Tarifa. Page 139 Price List.



Ajustador de cuerda de acero cincado versátil y fácil de utilizar. Ideal para la unión, extensión y fijación de cuerdas.

Rope extender made of zinc-plated steel. Versatile and easy to use. Ideal to link, extend and fix ropes.

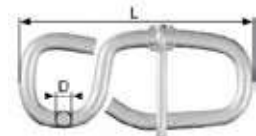

► Polibag - Ajustador de cuerda

D Ø	Uds. por polibag Uts. per polybag	Cód. producto Product code	Cód. EAN EAN code	Ud. acondicionado Minimum order quantity
7 mm	1	813802114030	8434035123557	5
7 mm	2	813802114040	8434035128286	5

D mm	L mm
7	75

► Caja - Ajustador de cuerda

D Ø	Uds. por caja Uts. per box	Cód. producto Product code	Cód. EAN EAN code
7 mm	10	813802117160	8434035128293
7 mm	25	813802117220	8434035128309
7 mm	100	813802117090	8434035122208



Todas las dimensiones y pesos indicados, especialmente las capacidades de carga, son valores teóricos. Antes de su uso, se debe de definir cual va a ser el propósito de estos artículos.
All dimensions and weights stated, especially load capacities, are theoretical values without obligation. The articles must be checked for their suitability for the purpose in mind before use.

Gancho carnicero

Meat hooks



Página 139 Tarifa. Page 139 Price List.

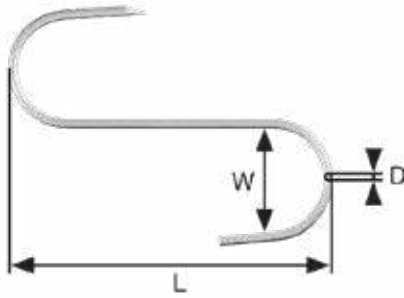

D mm	L mm	W mm	Acero inox. Stain. steel
4,4	100	30	ACERO INOX

Gancho carnicero de acero inoxidable, incorpora una punta afilada para enganchar carnes. Resistente a la corrosión.
Meat hook of stainless steel that has a sharp tip to hook meat. It is rust resistant.



► Polibag - Gancho carnicero

D Ø	Uds. por polibag Uts. per polybag	Cód. producto Product code	Cód. EAN EAN code	Ud. acondicionado Minimum order quantity	Acero inox. Stainless steel
4,4 mm	2	813902994040	8434035123564	5	ACERO INOX



► Promobox - Gancho carnicero

D Ø	Uds. por promobox Uts. per promobox	Cód. producto Product code	Cód. EAN EAN code	Acero inox. Stainless steel
4,4 mm	10	813902995160	8434035127906	ACERO INOX

Gancho tornillo

Screw hook for clothes lines

Página 139 Tarifa. Page 139 Price List.

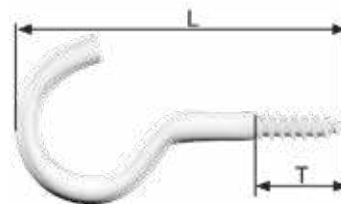

L mm	T mm
65	25

Gancho tornillo cincado recubierto de plástico. Especial para tender y soportar objetos pesados.
Screw hook made of zinc-plated steel, coated with plastic. Specially made for clothes lines, intended to support heavy objects.



► Polibag - Gancho tornillo

L mm	Uds. por polibag Uts. per polybag	Cód. producto Product code	Cód. EAN EAN code	Ud. acondicionado Minimum order quantity
65 mm	2	814102654040	8434035123625	5
65 mm	4	814102654070	8434035128248	5
65 mm	10	814102654160	8434035128262	5

Todas las dimensiones y pesos indicados, especialmente las capacidades de carga, son valores teóricos. Antes de su uso, se debe de definir cual va a ser el propósito de estos artículos.
All dimensions and weights stated, especially load capacities, are theoretical values without obligation. The articles must be checked for their suitability for the purpose in mind before use.

Mosquetón nylon

Nylon snap hook

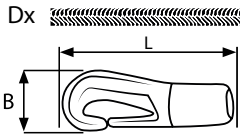

Dx Ø mm	L mm	B mm
6	45	20
8	75	28

Mosquetón de nylon para cuerda elástica de fácil uso y montaje. Ideal para una conexión sin nudos.

Nylon snap hook for elastic rope. Easy to use and install. Ideal for links without knots.

► Polibag - Mosquetón nylon



D Ø	Uds. por polibag Uts. per polybag	Cód. producto Product code	Cód. EAN EAN code	Ud. acondicionado Minimum order quantity
6 mm	2	815007104046	8434035125841	5
8 mm	2	815007124046	8434035125858	5

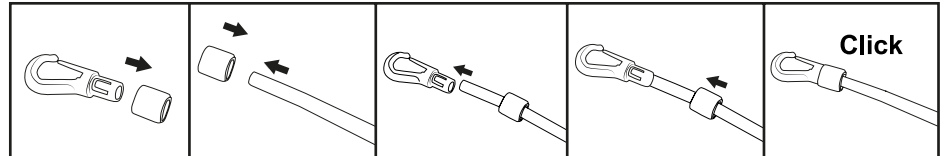

Gancho negro power grip

Power grip black hook

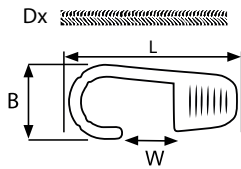

Dx Ø mm	L mm	B mm	W mm
8	83	35	25

Gancho power grip de acero recubierto de plástico en color negro para cuerda elástica de fácil uso y montaje. Ideal para una sujeción más segura de la carga.

Snap hook made of steel and coated with black plastic for applications with elastic ropes. Easy to use and install. Ideal for securing loads.

► Polibag - Gancho negro power grip



D Ø	Uds. por polibag Uts. per polybag	Cód. producto Product code	Cód. EAN EAN code	Ud. acondicionado Minimum order quantity
8 mm	2	815311074046	8434035125926	5

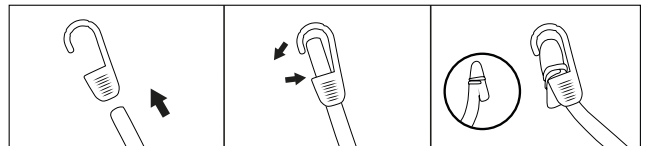

Gancho metálico plastificado

Plastic coated metallic hook

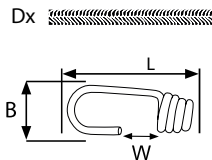

Dx Ø mm	L mm	B mm	W mm
8	66	30	15
10	76	32	21

Gancho metálico plastificado para cuerda elástica de fácil uso y montaje. Ideal para una sujeción más segura de la carga.

Metal hook coated with black plastic for applications with elastic ropes. Easy to use and install. Ideal for securing loads.

► Polibag - Gancho metálico plastificado



D Ø	Uds. por polibag Uts. per polybag	Cód. producto Product code	Cód. EAN EAN code	Ud. acondicionado Minimum order quantity
8 mm	2	815111124046	8434035125872	5
10 mm	2	815111144046	8434035125889	5

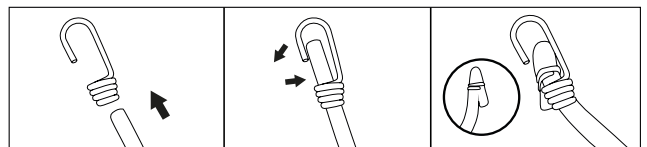

Todas las dimensiones y pesos indicados, especialmente las capacidades de carga, son valores teóricos. Antes de su uso, se debe de definir cual va a ser el propósito de estos artículos.
All dimensions and weights stated, especially load capacities, are theoretical values without obligation. The articles must be checked for their suitability for the purpose in mind before use.

Gancho plástico blanco

White plastic hook

Página 140 Tarifa. Page 140 Price List.

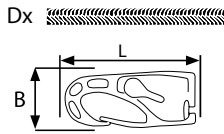

Dx Ø mm	L mm	B mm
8	65	25



Gancho plástico en color blanco para cuerda elástica de fácil uso y montaje. Ideal para una sujeción más segura de la carga.

Plastic hook in white for applications with elastic ropes. Easy to use and install. Ideal for securing loads.

► Polibag - Gancho plástico blanco

D Ø	Uds. por polibag Uts. per polybag	Cód. producto Product code	Cód. EAN EAN code	Ud. acondicionado Minimum order quantity
8 mm	2	815412004044	8434035125940	5

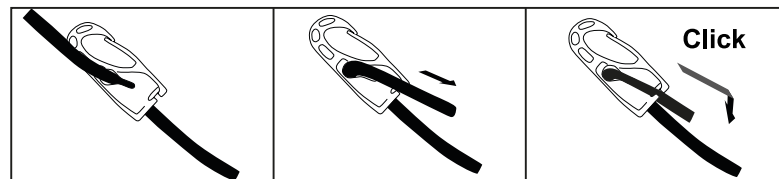

Gancho plástico negro

Black plastic hook

Página 140 Tarifa. Page 140 Price List.

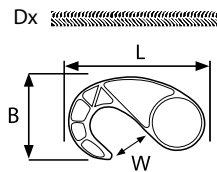

Dx Ø mm	L mm	B mm	W mm
8	70	45	23



Gancho plástico en color negro para cuerda elástica de fácil uso y montaje. Ideal para una sujeción más segura de la carga.

Plastic hook in black for applications with elastic ropes. Easy to use and install. Ideal for securing loads.

► Polibag - Gancho plástico negro

D Ø	Uds. por polibag Uts. per polybag	Cód. producto Product code	Cód. EAN EAN code	Ud. acondicionado Minimum order quantity
8 mm	2	815212124046	8434035125964	5



Todas las dimensiones y pesos indicados, especialmente las capacidades de carga, son valores teóricos. Antes de su uso, se debe de definir cual va a ser el propósito de estos artículos.
All dimensions and weights stated, especially load capacities, are theoretical values without obligation. The articles must be checked for their suitability for the purpose in mind before use.

Mosquetón Rombull

Rombull snap hook

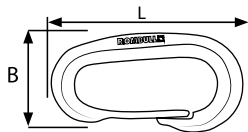

L mm	B mm
60	30

Mosquetón Rombull fabricado en poliamida y resistente a los rayos solares. Ideal para la instalación de redes tanto de uso doméstico como profesional. Uso fácil y rápido.

Rombull carabiner made of polyamide with UV protection. Especially suited for the professional and domestic installment of nets. Easy and quick to use.



► Polibag - Mosquetón Rombull

L mm	Uds. por polibag Uts. per polybag	Cód. producto Product code	Cód. EAN EAN code	Ud. acondicionado Minimum order quantity
60 mm	2	815707604046	8434035128989	5



► Caja - Mosquetón Rombull

L mm	Uds. por caja Uts. per box	Cód. producto Product code	Cód. EAN EAN code
60 mm	15	815707607176	8434035128903
60 mm	25	815707607226	8434035128910
60 mm	50	815707607116	8434035128927
60 mm	100	815707607096	8434035128934
60 mm	250	815707607296	8434035128941
60 mm	500	815707607156	8434035128965
60 mm	1000	815707607756	8434035128972



Todas las dimensiones y pesos indicados, especialmente las capacidades de carga, son valores teóricos. Antes de su uso, se debe de definir cual va a ser el propósito de estos artículos.
All dimensions and weights stated, especially load capacities, are theoretical values without obligation. The articles must be checked for their suitability for the purpose in mind before use.

Mosquetón clip

Clip snap hook

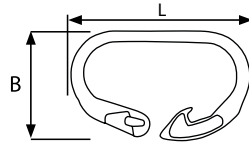

L mm	B mm
56	30

Mosquetón clip fabricado en homopolímero y resistente a los rayos solares. Ideal para la instalación de redes tanto de uso doméstico como profesional. Uso fácil y rápido.

Carabiner snap clip hook made of homopolymer with UV protection. Especially suited for the professional and domestic installation of nets. Easy and quick to use.



► Polibag - Mosquetón clip

L mm	Uds. por polibag Uts. per polybag	Cód. producto Product code	Cód. EAN EAN code	Ud. acondicionado Minimum order quantity
56 mm	2	815607634046	8434035128880	5



► Caja - Mosquetón clip

L mm	Uds. por caja Uts. per box	Cód. producto Product code	Cód. EAN EAN code
56 mm	50	815607637116	8434035128828
56 mm	100	815607637096	8434035128835
56 mm	250	815607637296	8434035128842
56 mm	500	815607637156	8434035128859
56 mm	2000	815607637766	8434035128866

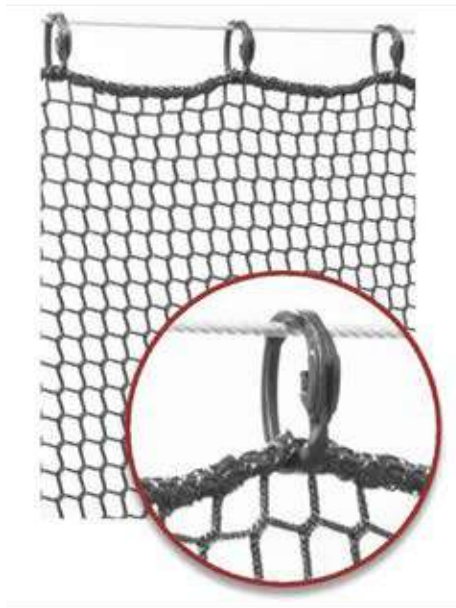

Todas las dimensiones y pesos indicados, especialmente las capacidades de carga, son valores teóricos. Antes de su uso, se debe de definir cual va a ser el propósito de estos artículos.
All dimensions and weights stated, especially load capacities, are theoretical values without obligation. The articles must be checked for their suitability for the purpose in mind before use.



RED SIN NUDO FÁCIL MONTAJE

VARIETADES DE MALLA, GROSOR Y COLOR
FABRICACIÓN PROPIA, REDES A MEDIDA

RED KNOT WITHOUT • EASY INSTALLATION

VARIETIES OF MESH, THICKNESSES AND COLORS
MANUFACTURED IN-HOUSE NETS AS



ROMBULL®

Solución Integral 360°

- | **Ubicación** Camino Los Clérigos Apdo. 9
Location 03360 CALLOSA DE SEGURA
Alicante - ESPAÑA
- | **Teléfonos** +34 966 758 13 0
Phones +34 638 929 36 4
- | **Fax** +34 965 312 528
- | **Web** www.rombull.es
- | **Mail** info@rombull.es | rombull@rombull.es
- | **GPS** 38° 07' 39.9" N
0° 50' 49.5" W



www.facebook.com/RombullRonets



www.twitter.com/RombullRonets



www.youtube.com/RombullRonets



Coordenadas GPS GPS Coordinates

Latitud 38° 07' 39.9" N
Longitud 0° 50' 49.5" W

● Camino Los Clérigos • Apdo. 9
03360 CALLOSA DE SEGURA
(Alicante)



SOMOS FABRICANTES



REDES DE SEGURIDAD
Safety nets



REDES DE DEPORTE
Sport nets



PARQUES DE AVENTURA
Adventure parks



REDES DE INDUSTRIA
Industrial netting



CORDELERÍA
DIY ropes



CORDELERÍA NATURAL
Natural ropes



MALLAS DE OCULTACIÓN Y SOMBREO
Shade nets



CABUYERÍA NÁUTICA
Nautical ropes



ELÁSTICOS Y TRINCAJES
Bungees and tie down



CABLES, CADENAS Y ACCESORIOS
Wire ropes, chains and accessories

Rombull Ronets S.L.
E-mail: info@rombull.es
www.rombull.es

Camino Los Clérigos, Apdo. 9
03360 Callosa de Segura
(Alicante)
Telf: (+34) 966 758 130
Fax: (+34) 965 312 528

